



# Selective Pallet Rack





**Available in both bolted and welded configurations, Interlake Mecalux Selective Pallet Rack is the most universal system for direct and individual access to each pallet.**

### Selective Pallet Rack

Combining vertical frames with horizontal load beams, selective pallet rack provides total accessibility to the product. Easily the most popular racking system in use today, it provides versatility for warehouses that have a wide variety of product types. It is manufactured from high-strength steel and other quality raw materials, which are certified to meet our stringent specifications.

Interlake Mecalux roll-formed selective pallet rack is available with bolted or welded frame configurations. Beams are mounted to the frame and held in place with a piston lock connector. This allows the beams to be seated securely without risk of accidental disengagement and enables them to be rearranged simply and easily when necessary. A variety of accessories are also available to improve the performance of the selective rack.

When a selective pallet rack system is designed for maximum throughput and storage capacity, the resulting system is built to accommodate years of growth.

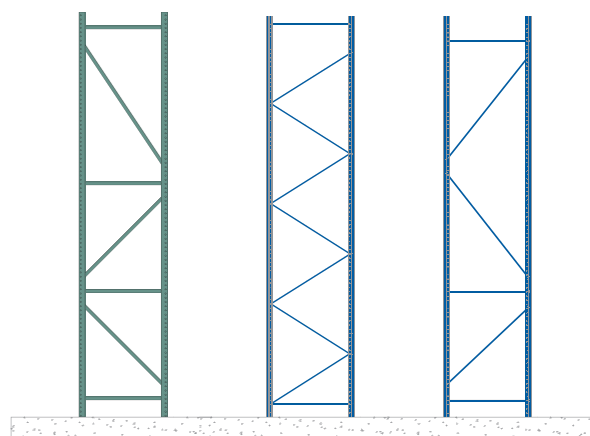
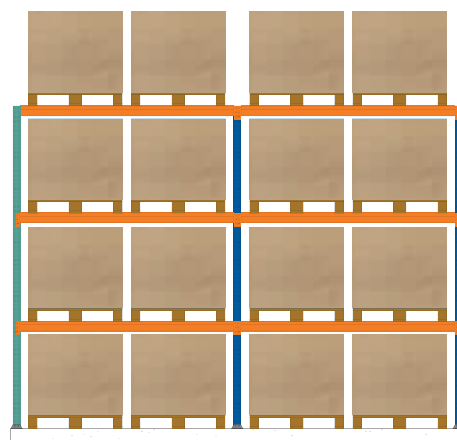
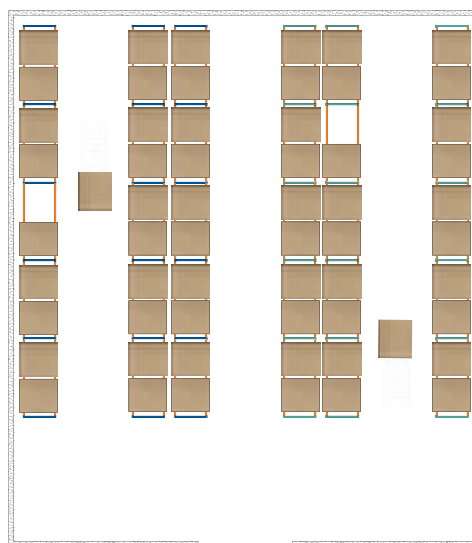

## Advantages

- Immediate access to every load provides efficient use of floor space and minimizes load/unload time.
- Automatic beam-to-frame locking reduces installation time and simplifies re-profiling.
- Handling one pallet requires no need to move others.
- Increases load flexibility in terms of both weight and volume.
- Availability of a wide variety of sizes, gauges and accessories custom fit to any application.

*Top:* Standard Selective floorplan.

*Middle:* Front elevation with combined Welded and Bolted frames.

*Bottom, left to right:* Welded strut pattern; Bolted strut pattern for U101 and U122; Bolted strut pattern for U77, U80, and U82.



# Frames

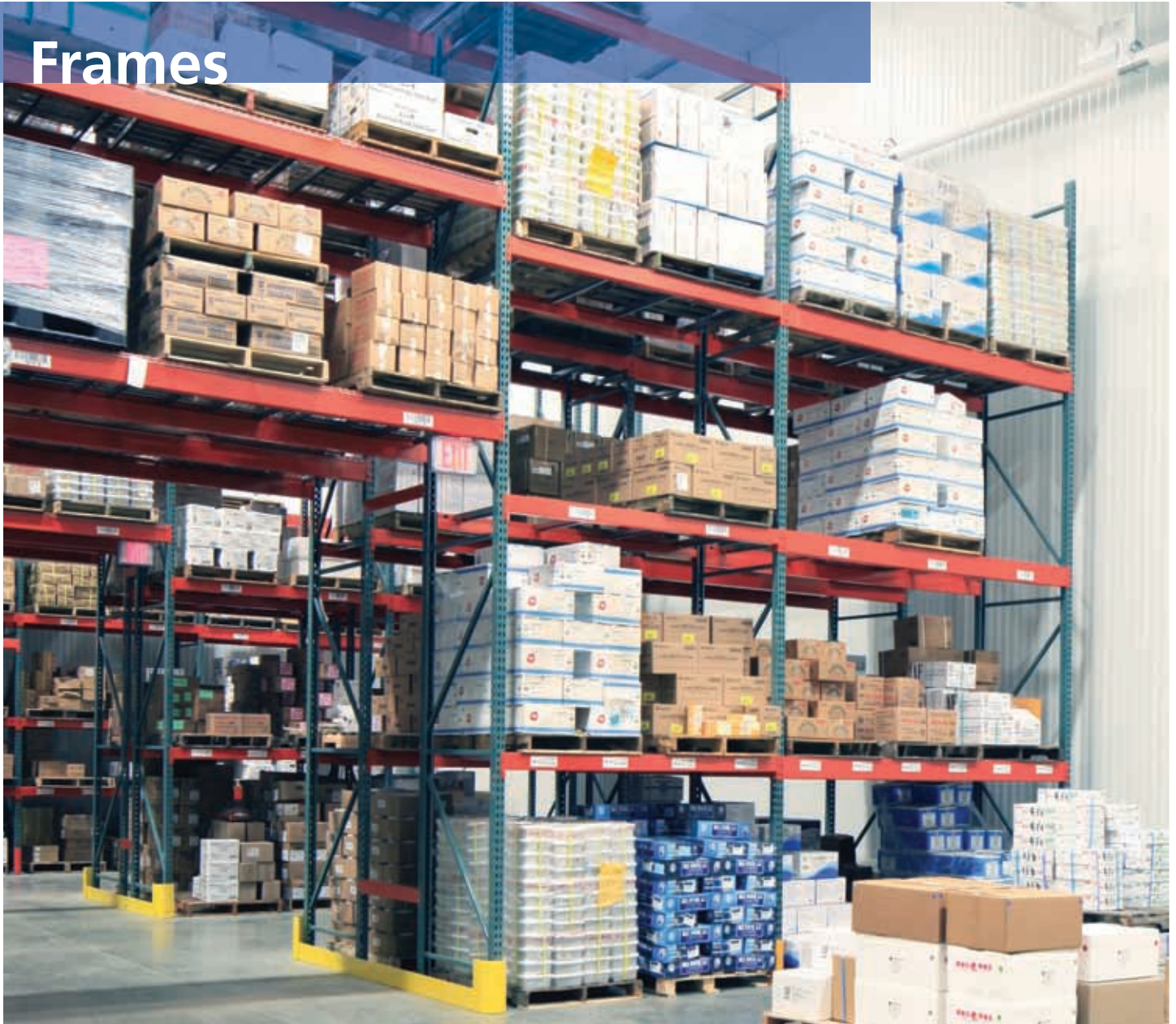

## Frames

Standard frames are made up of two posts (columns), horizontal and diagonal bracing (struts), and footplates. Posts are available in a variety of gauges and lengths as well as configurations for seismic zones. Columns are braced along the vertical length to be more resistant to axial loading and to restrict separation and twisting of the column sections under load.

The capacities shown are:

- applicable for non-seismic use only.
- shown in pounds (lbs) and for product load plus dead load (dead load = 2.0% of product load).
- only valid when used with Interlake Mecalux published beam sizes.
- accurate for static loads only.

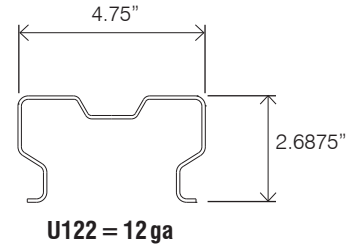
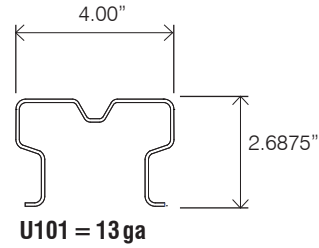
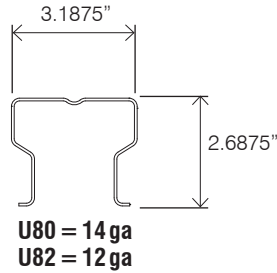
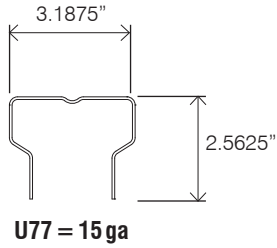

Bolted Post Capacity <sup>(2)</sup> (lbs)					
Maximum Unsupported Length <sup>(1)</sup>	U77	U80	U82	U101	U122
	0.067" thick	0.070" thick	0.105" thick	0.090" thick	0.105" thick
	15 Gauge	14 Gauge	12 Gauge	13 Gauge	12 Gauge
36"	20,930	26,520	38,820	36,440	47,880
42"	20,930	25,880	37,800	36,440	47,880
48"	19,980	24,540	35,480	36,440	47,880
54"	18,710	23,040	33,120	35,060	47,880
60"	17,290	21,360	30,360	33,480	47,500
66"	15,730	19,500	27,560	31,740	45,600
72"	14,010	17,460	24,680	29,820	43,700
78"	12,150	15,260	21,420	27,760	41,600
84"	10,480	13,160	18,480	25,520	39,380
90"	9,130	11,460	16,100	23,120	37,040
96"	8,020	10,080	14,140	20,540	34,560

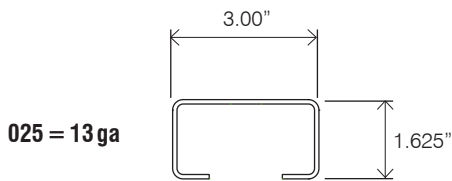

**O70 = 14 ga**  
**O75 = 13 ga**  
**O77 = 12 ga**  
**O79 = 11 ga**

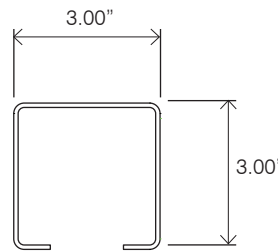

**O95 = 13 ga**  
**O99 = 11 ga**

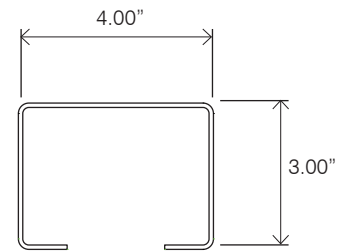

Welded Post Capacity <sup>(2)</sup> (lbs)							
Maximum Unsupported Length <sup>(1)</sup>	O25	O70	O75	O77	O79	O95	O99
	0.090" thick	0.070" thick	0.090" thick	0.105" thick	0.120" thick	0.090" thick	0.120" thick
	13 Gauge	14 Gauge	13 Gauge	12 Gauge	11 Gauge	13 Gauge	11 Gauge
36"	23,400	28,600	38,400	44,300	50,000	37,500	60,200
42"	21,900	25,900	34,600	39,800	44,900	37,500	60,200
48"	19,300	23,000	30,600	35,200	39,700	36,300	57,900
54"	16,700	20,000	26,400	30,400	34,300	33,900	53,200
60"	15,000	17,700	23,100	26,600	30,000	31,300	48,400
66"	13,400	16,000	20,900	24,000	27,100	28,500	43,500
72"	11,700	14,400	18,700	21,400	24,100	25,800	38,700
78"	10,300	12,800	16,500	19,000	21,300	23,200	34,500
84"	9,100	11,400	14,700	16,900	19,000	21,700	31,900
90"	8,000	10,200	13,100	15,100	16,900	20,100	29,400
96"	7,100	9,200	11,800	13,500	15,200	18,600	26,800

All posts are cold roll formed using 55,000 P.S.I. minimum yield steel and have been designed to meet RMI specifications.

(1) Maximum unsupported length is measured from the floor to the top of the first beam to top of beam; use the larger of these dimensions.

(2) These capacities assume that all component parts are: a. Manufactured by Interlake Mecalux. b. In good condition. c. Properly maintained.



# Beams



## Beams

Load beams are roll formed with a 1-5/8" step along the top inside edge for holding load support components such as pallet supports or wire decks. Capacities are for uniformly distributed product load plus dead load per pair of beams (dead load = weight of beams) and are applicable for non-seismic use only.

## Slotted and Unslotted

Beams can be slotted on the step ledge at 1" centers as an option. Slots allow the penetration of a fabricated tab to restrict the horizontal movement of a crossbar (pallet support). Due to the manufacturing process, slot cut-off points are random at the end of each beam.

All beams receive two solid coats of paint on every surface and are then oven baked. Beam safety factor conforms to current RMI standards (RMI specs). The allowable distributed load per pair of beams is based on a maximum deflection of  $L/180$  (1/180th of beam span).

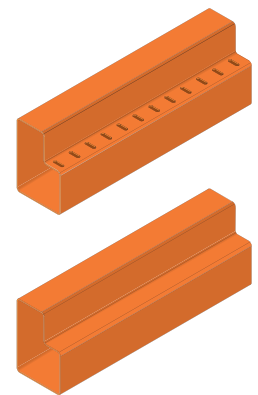

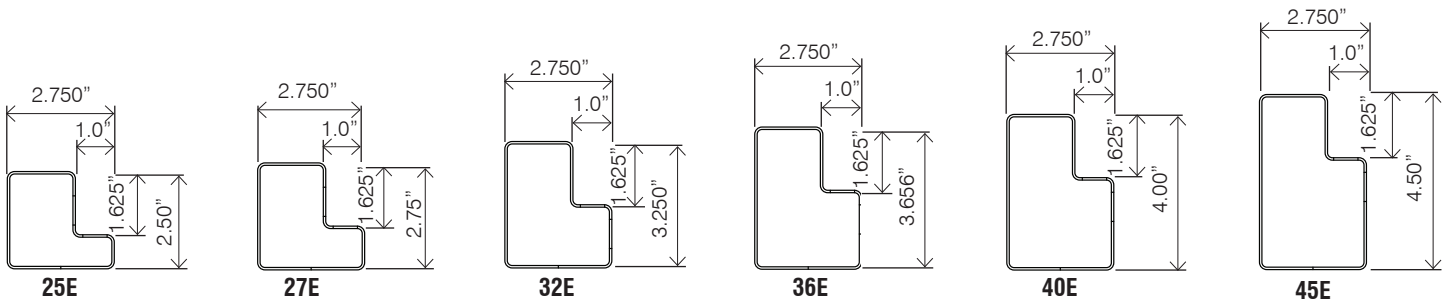

### Slotted and Unslotted Step Beam Capacity <sup>(2)</sup> (lbs per pair)

Span <sup>(1)</sup>	25E	27E	32E	36E	40E	45E	47E	50E	55E	59E	65E	65Q
48"	4,370	5,020	6,590	7,770	8,840	10,540	11,580	12,470	14,470	15,120	15,120	15,120
54"	3,910	4,490	5,910	6,950	7,910	9,410	10,350	11,140	12,910	14,480	15,120	15,120
60"	3,550	4,060	5,370	6,300	7,160	8,510	9,360	10,070	11,660	13,080	15,120	15,120
66"	3,380	4,110	5,450	6,390	7,250	8,600	9,470	10,180	11,790	13,210	15,120	15,120
72"	2,870	3,560	5,040	5,890	6,680	7,920	8,720	9,380	10,850	12,150	14,190	15,120
78"	2,470	3,060	4,690	5,480	6,200	7,340	8,090	8,690	10,050	11,250	13,140	15,120
84"	2,150	2,660	4,120	5,120	5,790	6,850	7,550	8,110	9,370	10,480	12,230	15,120
90"	1,900	2,340	3,630	4,660	5,430	6,420	7,080	7,600	8,780	9,820	11,450	15,120
96"	1,690	2,080	3,230	4,130	5,030	6,040	6,670	7,160	8,260	9,230	10,770	14,350
102"	1,510	1,860	2,900	3,690	4,490	5,710	6,310	6,760	7,810	8,720	10,160	13,530
108"	1,360	1,670	2,620	3,330	4,040	5,260	5,990	6,420	7,400	8,260	9,620	12,810
114"	1,240	1,520	2,380	3,020	3,660	4,750	5,540	6,100	7,040	7,850	9,140	12,170
120"	1,130	1,380	2,170	2,750	3,330	4,320	5,030	5,630	6,710	7,480	8,710	11,580
126"	1,040	1,270	1,990	2,520	3,040	3,940	4,600	5,140	6,350	7,080	8,240	10,950
132"	960	1,170	1,840	2,320	2,800	3,620	4,220	4,710	5,910	6,780	7,890	10,480
138"	890	1,080	1,700	2,140	2,580	3,330	3,890	4,340	5,440	6,460	7,570	10,040
144"	830	1,010	1,590	1,990	2,400	3,080	3,600	4,020	5,020	5,970	7,270	9,650
150"	-	-	-	-	-	-	3,340	3,730	4,660	5,530	7,000	9,050
156"	-	-	-	-	-	-	3,120	3,470	4,330	5,140	6,530	8,410
162"	-	-	-	-	-	-	2,910	3,240	4,050	4,790	6,080	7,830
168"	-	-	-	-	-	-	2,730	3,040	3,790	4,480	5,690	7,310

(1) Beams longer than 90" that support decking must be tied together to prevent spreading. Beams over 108" long should have an extra lateral support installed mid-span.

(2) These capacities assume that all component parts are: a. Manufactured by Interlake Mecalux. b. In good condition. c. Properly maintained.

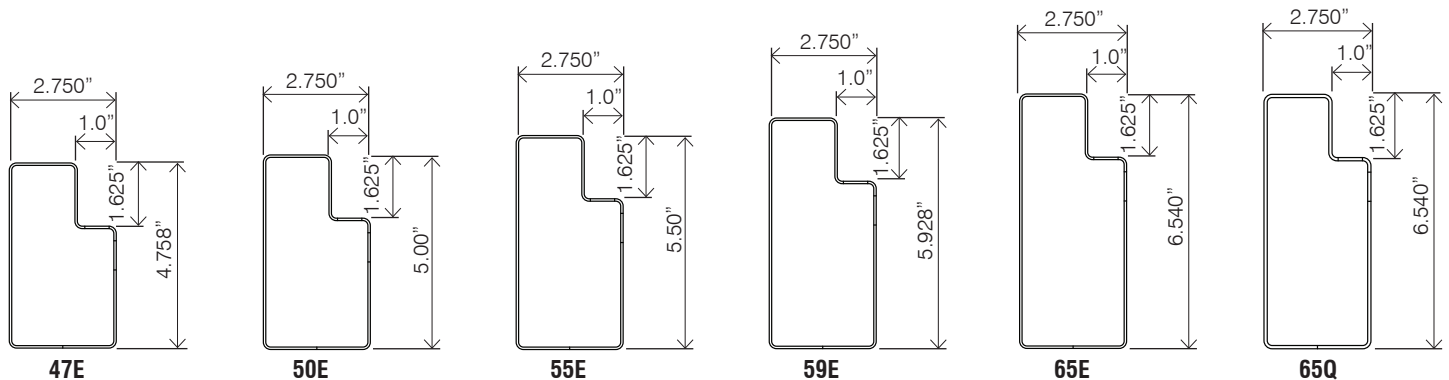

# Beams

## Z Beams

Z beams are a lighter capacity beam designed to support particle board or wire decking. Named "Z" because of the profile, Z beams are used in the construction of picking areas. They are available with a 3-pin tear drop connection to fit securely within a selective bay.



Z Beam Capacity (lbs per pair)		
Span	ZS-U60	ZS-U65
48"	-	-
54"	3,800	-
60"	3,600	-
72"	3,000	1,985
78"	2,800	1,808
84"	2,600	1,742
90"	2,600	1,654
92"	2,400	1,566
96"	2,350	1,433
102"	2,220	-
108"	2,100	-

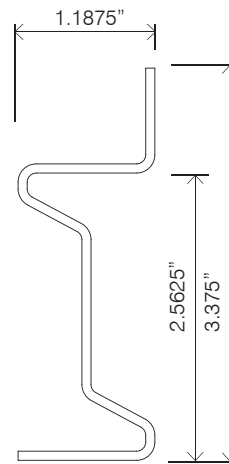

**ZS Beams-U65 = 14 ga**  
For use with wire decking



## Weld Type Options

Under normal, static loading conditions, the "A" weld is sufficient. The end plates are welded to the beam along the front and rear face of the beam edge. For certain seismic loading conditions, "B", "C", or "D" welds are also available.

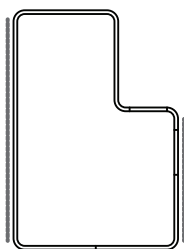

"A" Type Weld

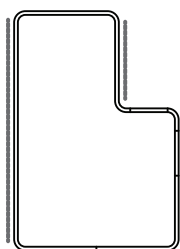

"B" Type Weld

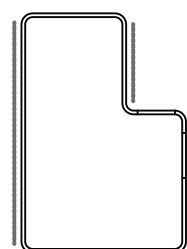

"C" Type Weld

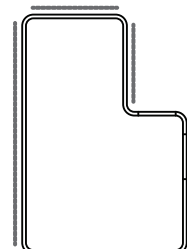

"D" Type Weld





## End Plates

The foundation of the Interlake Mecalux selective rack system is the unprecedented beam-to-upright connection offered in the Piston Lock automatic locking device. The stud design and column punching draw tighter together under load to create the industry's most secure connection while maximizing system capacity.

Our proprietary locking system engages automatically upon beam seating, making installation and re-profiling easier while protecting against accidental beam release. The piston lock is damage- and tamper- resistant, and stays snugly in place during use.

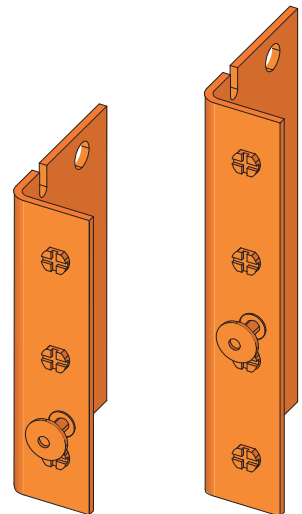

# Components and Accessories

- |                        |                             |
|------------------------|-----------------------------|
| 1) Frame               | 7) Galvanized steel panel   |
| 2) Footplate           | 8) Palletstop               |
| 3) Shim                | 9) Bolt-on column protector |
| 4) Beam                | 10) Drum support            |
| 5) Post protector      | 11) Row spacer              |
| 6) End aisle protector | 12) Pallet support          |

## Welded Frames

Interlake Mecalux welded frames have a powder coat finish in Vista Green and, as with bolted, have a tear drop punch. The bracing and footplates are welded to the frame columns by AWS certified welding technicians. Horizontal and diagonal struts are cut to a length that penetrates the column and then permanently attached with a 1" fillet weld at each connection.

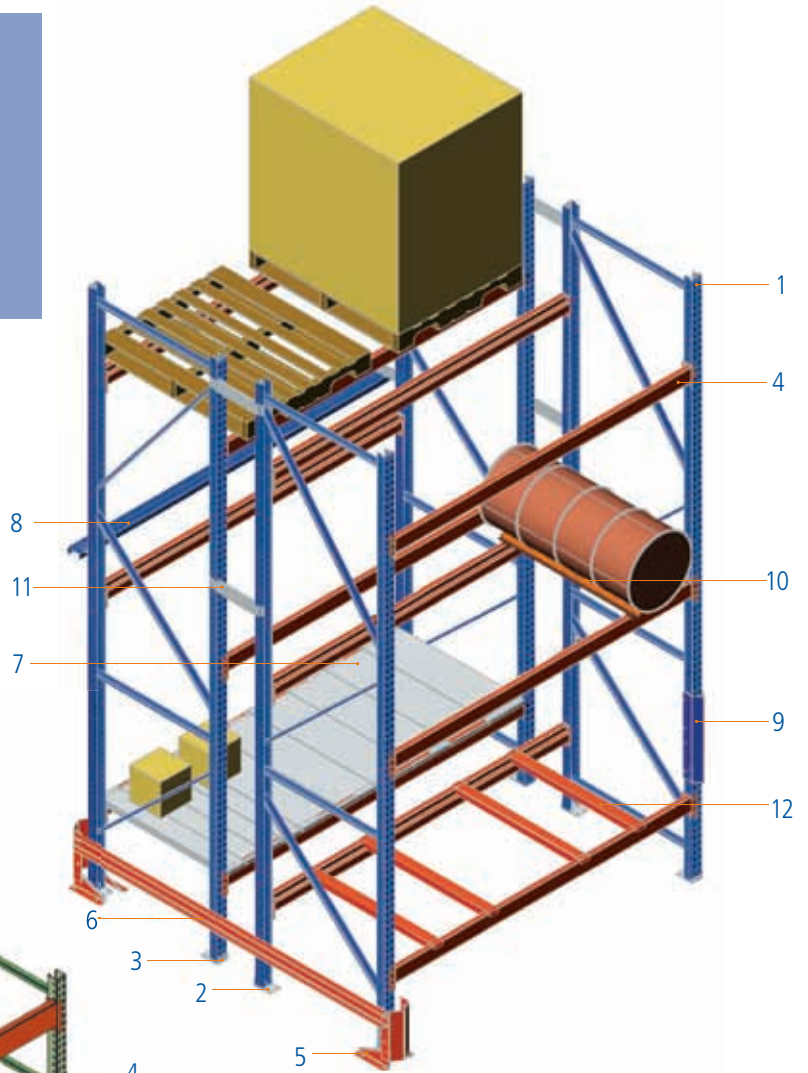
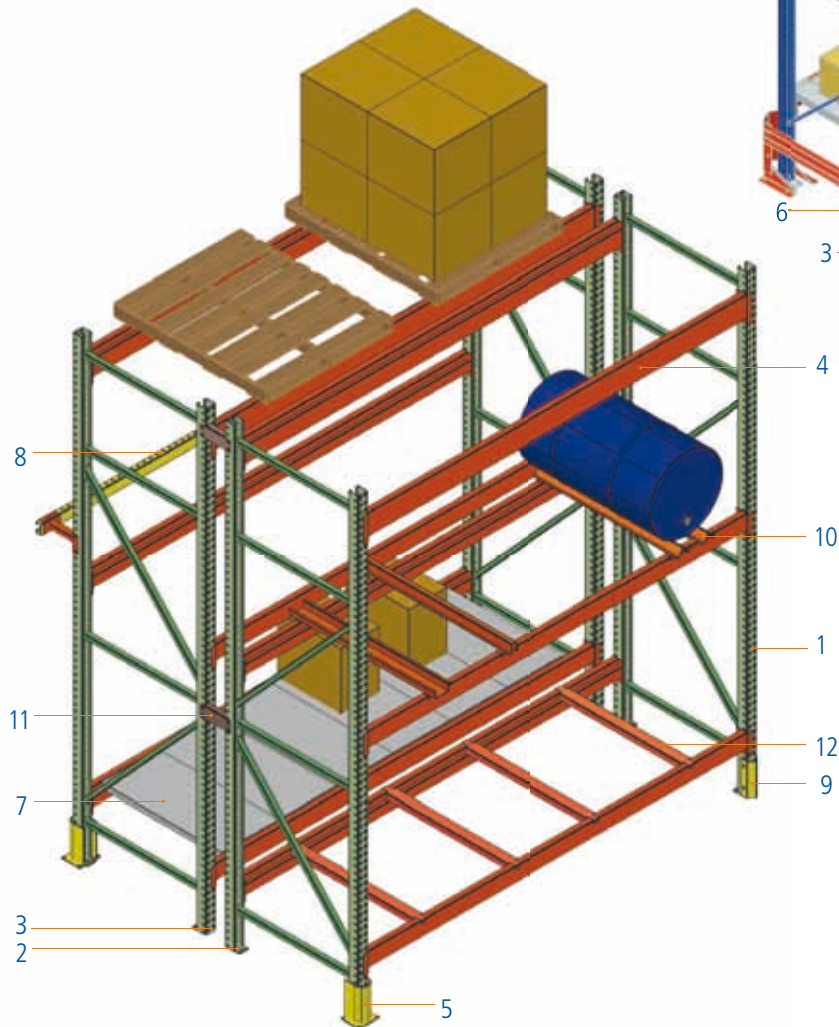

## Bolted Frames

Interlake Mecalux bolted frames are painted Mecalux Blue with a Cataphoresis paint process. With Cataphoresis, the frames are electro-statically immersed in epoxy paint to ensure that the paint saturates every surface. This provides corrosion resistance to rival galvanizing. The bracing and footplates are bolted to the tear drop punched frame columns. All bolts are Grade 5 with a serrated locking nut for a secure connection. In many seismic applications, the footplates are welded to the column for additional stability. Bolted frames are shipped assembled unless otherwise requested.



A variety of accessories are available for selective rack systems. From pallet supports to column protectors, Interlake Mecalux has accessories to meet any need. Some examples of these accessories are shown below.

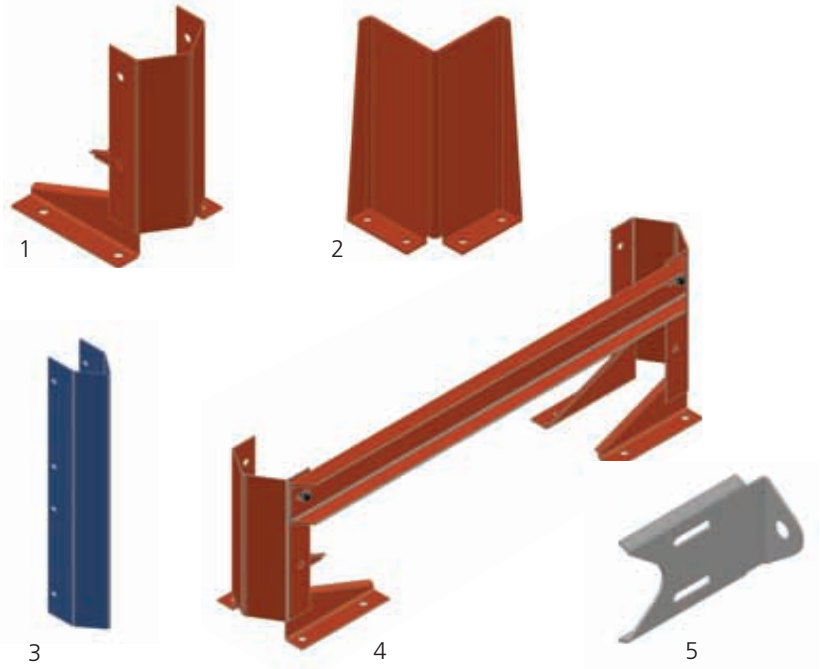

### Bolted Accessories

1. Column Protector
2. Corner Guard
3. Bolt-on Post Protector
4. End of Aisle Protector
5. Wall Tie

### Welded Accessories

1. Bolt-On Post Protector
2. Column Protector
3. Row Spacer
4. Wall Tie

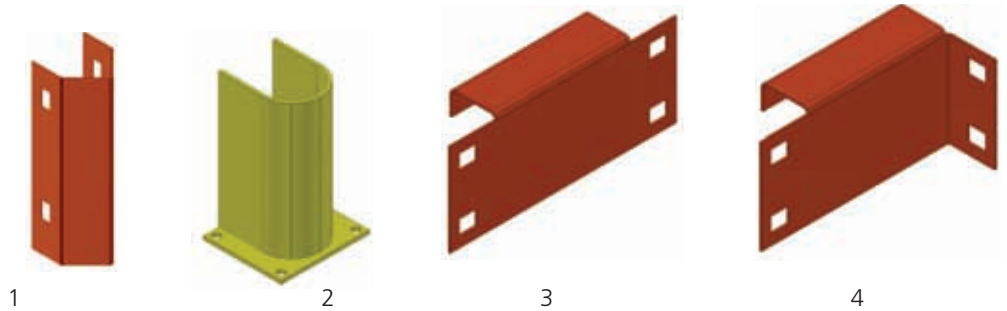

### Beam Accessories

1. Drum/Coil Bed
2. Fork Clearance Bar
3. Skid Channel
4. Roll-In Pallet Support
5. Double-Flanged Pallet Support

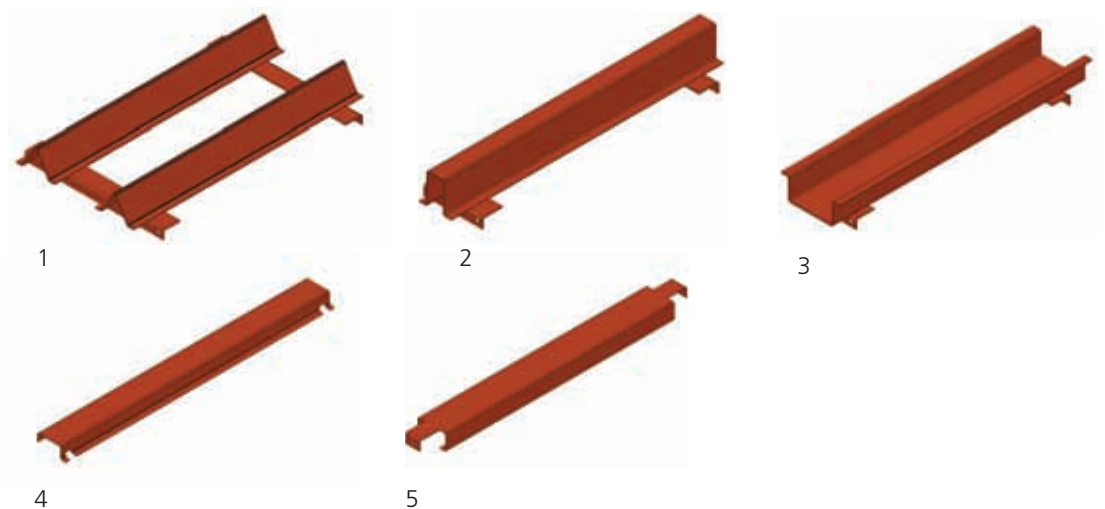

**MANUFACTURING FACILITIES**



**RESEARCH & DEVELOPMENT CENTERS**



**US CORPORATE HEADQUARTERS**  
 1600 North 25th Avenue  
 Melrose Park, IL 60160

**Pontiac**  
 701 Interlake Drive  
 Pontiac, IL 61764

**Dallas**  
 1520 Selene Drive  
 Carrollton, TX 75006

**Matamoros**  
 Las Rusias 2700  
 Matamoros, Tamps,  
 MX 87470

**Sumter**  
 1925 Corporate Way  
 Sumter, SC 29154

**San Diego**  
 8607 Ave. de la Fuente  
 San Diego, CA 92154

**Tijuana**  
 Blvd. Bellas Artes #9001  
 Tijuana, Baja California,  
 MX 22500

**Lexington**  
 804 Newtown Circle, Suite B  
 Lexington, KY 40511

**Naperville**  
 1230 East Diehl Rd.  
 Naperville, IL 60563

**Retail Service Solutions**  
 1200 Chastain Road, Suite 310  
 Kennesaw, GA 30144

**OFFICES WORLDWIDE**

Argentina, Belgium, Brazil, Canada, Chile, Czech Republic, France, Germany, Italy, Mexico, Poland, Portugal, Spain, United Kingdom, USA

**e-mail: [info@interlakemecalux.com](mailto:info@interlakemecalux.com) | [www.interlakemecalux.com](http://www.interlakemecalux.com) | 1.877.632.2589**



The contents in this document refer exclusively to Mecalux products and are for informational and promotional purposes only. The information contained herein does not form the basis for warranty or guarantee. Mecalux reserves the right to modify without prior notice the data, figures, products and finishes in the catalog.