

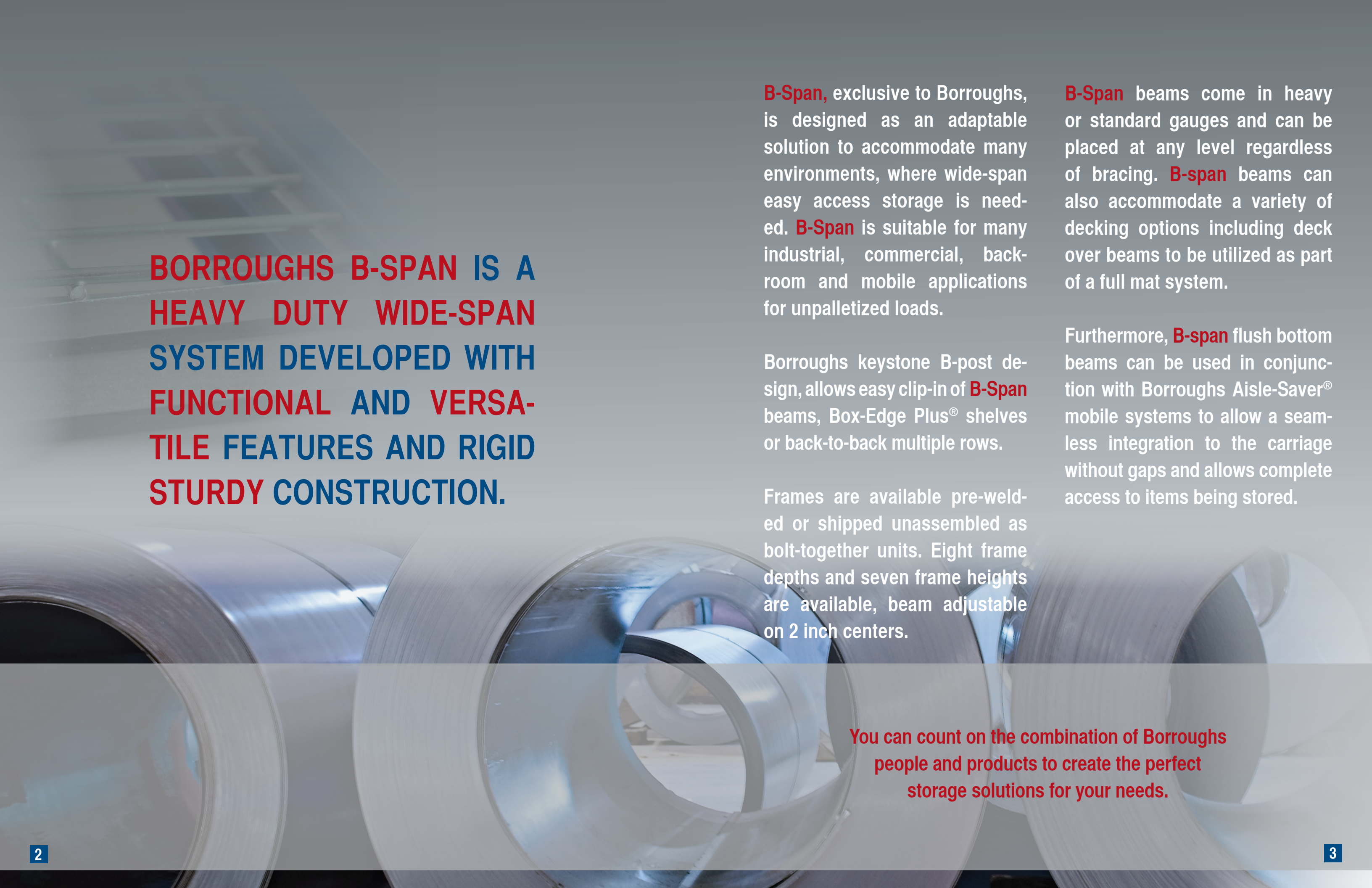

**heavy duty
wide-span
shelving**

BSpan

 **Borroughs**
CORPORATION



BORROUGHS B-SPAN IS A HEAVY DUTY WIDE-SPAN SYSTEM DEVELOPED WITH FUNCTIONAL AND VERSATILE FEATURES AND RIGID STURDY CONSTRUCTION.

B-Span, exclusive to Borroughs, is designed as an adaptable solution to accommodate many environments, where wide-span easy access storage is needed. **B-Span** is suitable for many industrial, commercial, back-room and mobile applications for unpalletized loads.

Borroughs keystone B-post design, allows easy clip-in of **B-Span** beams, Box-Edge Plus® shelves or back-to-back multiple rows.

Frames are available pre-welded or shipped unassembled as bolt-together units. Eight frame depths and seven frame heights are available, beam adjustable on 2 inch centers.

B-Span beams come in heavy or standard gauges and can be placed at any level regardless of bracing. **B-span** beams can also accommodate a variety of decking options including deck over beams to be utilized as part of a full mat system.

Furthermore, **B-span** flush bottom beams can be used in conjunction with Borroughs Aisle-Saver® mobile systems to allow a seamless integration to the carriage without gaps and allows complete access to items being stored.

You can count on the combination of Borroughs people and products to create the perfect storage solutions for your needs.

B-Span design features, components and options



The B-Span Post

- Allows for beam adjustment on 2" centers
- Recessed tail flange keeps hardware from encroaching into storage space (bolt together)
- Posts punch to accommodate Borroughs Box Edge Plus Shelves

B-Span Frames

- Frames are available as pre-welded or bolted together units
- Frames come in heights 48"-144" high and depths 12"-48"
- Frames can be used for both B-Span beams and/or Box Edge Plus® shelves

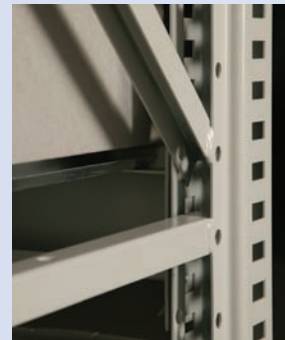

Frames are available as Pre-Welded (right unit shown) or To-Assemble units (left unit shown).

B-Span Beams

- Beams choose 14 gauge (standard duty) or 12 gauge (heavy duty)
- Beams are available in 4, 5, 6, 7, 8, 9 & 10 ft. widths, adjustable on 2" centers
- Beam steps are 7/16" or 3/4" to accommodate various decking options
- Beams can be placed at any level regardless of bracing or splices
- Deck over beams can be utilized as part of a full mat system
- Flush bottom beams are available for seamless Aisle-Saver® mobile integration

Decking Options

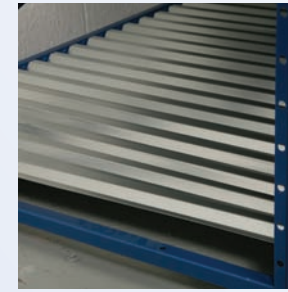

Corrugated Steel
22 gauge galvanized corrugated decking.

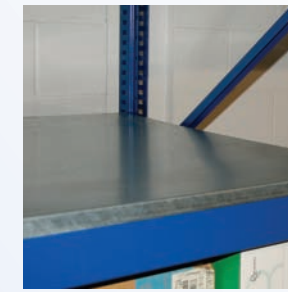

Flat Steel
Flat steel panel with water fall front and back edges fits over beams and corrugated decking.



Wire Decking
Heavy duty galvanized, drop in wire panels.

Splicers



B-Span splicers provide a solid connection for frames when heights over 12' are required.

B-Clip



Provides a solid connection between posts and beams. **B-Clips come standard with a passive safety spring clip.**

Back to Back Ties



Maintains consistent floor space between units and allows for the easy adjustment of beams.

Wall Ties

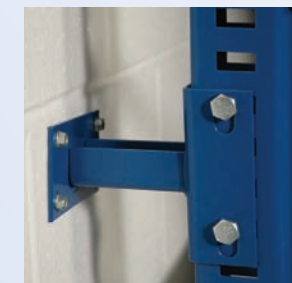

Wall ties anchor frames to wall and maintain adequate distance to allow beam adjustment.

Foot Plates

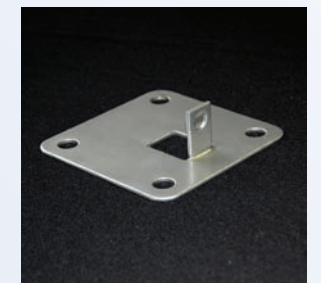

Secures uprights to the floor.

Part Numbers

Posts

HEIGHT	BULK RACK POST	WEIGHT
48"	60000-000	8.4
60"	60000-001	10.4
72"	60000-002	12.5
84"	60000-003	14.6
96"	60000-004	16.7
120"	60000-005	20.8
144"	60000-006	25.0

Braces

DEPTH	HORIZONTAL BRACES	WEIGHT
12"	60001-000	0.7
15"	60001-001	0.8
18"	60001-002	0.8
24"	60001-003	1.1
30"	60001-004	1.3
36"	60001-005	1.5
42"	60001-006	1.8
48"	60001-007	2.0

DEPTH	DIAGONAL BRACES	WEIGHT
12"	60004-000	1.3
15"	60004-001	1.4
18"	60004-002	1.5
24"	60004-003	1.7
30"	60004-004	1.9
36"	60004-005	2.0
42"	60004-006	2.2
48"	60004-007	2.4

Bracing Patterns for Upright Frames

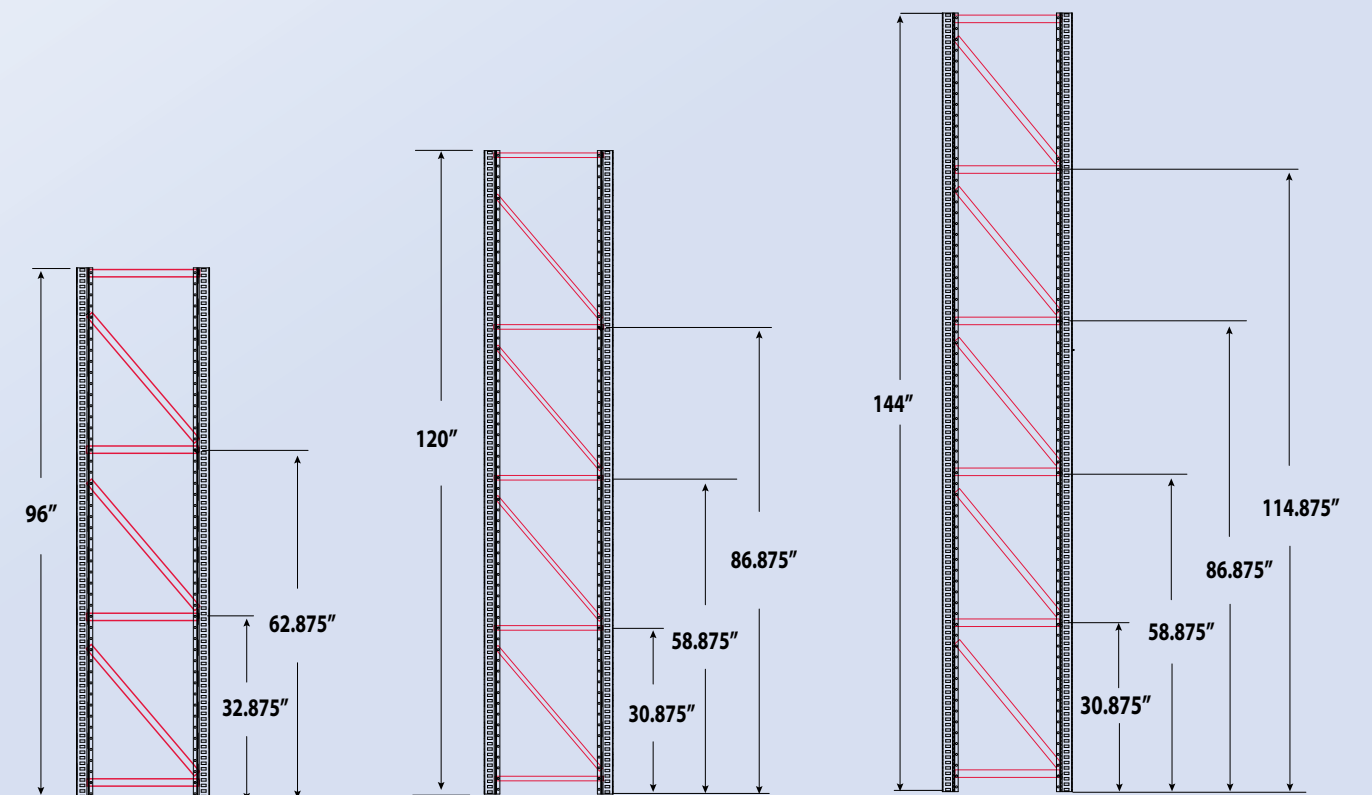
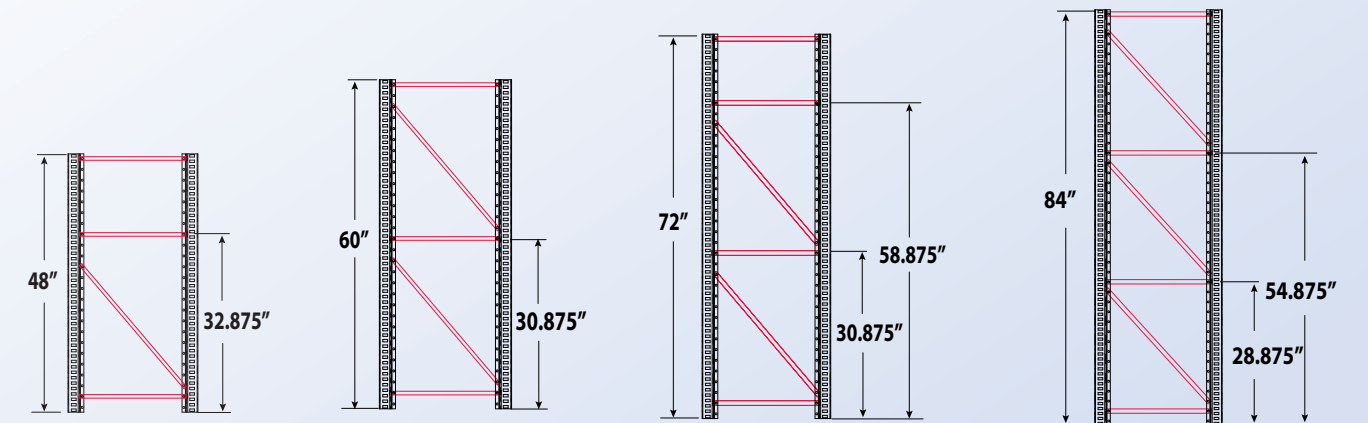

Frames

FRAME (DxH)	PRE-WELDED	WEIGHT	TO-ASSEMBLE	WEIGHT
12x48	60002-001	19.5	60007-001	19.5
12x60	60002-002	23.5	60007-002	23.5
12x72	60002-003	27.7	60007-003	27.7
12x84	60002-004	31.9	60007-004	31.9
12x96	60002-005	38.1	60007-005	38.1
15x48	60002-008	19.8	60007-008	19.8
15x60	60002-009	23.8	60007-009	23.8
15x72	60002-010	28.0	60007-010	28.0
15x84	60002-011	32.2	60007-011	32.2
15x96	60002-012	38.6	60007-012	38.6
18x48	60002-015	20.0	60007-015	20.0
18x60	60002-016	24.0	60007-016	24.0
18x72	60002-017	28.4	60007-017	28.4
18x84	60002-018	32.6	60007-018	32.6
18x96	60002-019	39.2	60007-019	39.2
24x48	60002-022	20.8	60007-022	20.8
24x60	60002-023	24.8	60007-023	24.8
24x72	60002-024	31.8	60007-024	31.8
24x84	60002-025	36.0	60007-025	36.0
24x96	60002-026	40.2	60007-026	40.2
24x120	60002-027	51.3	60007-027	51.3
24x144	60002-028	59.7	60007-028	59.7
30x48	60002-029	21.6	60007-029	21.6
30x60	60002-030	25.4	60007-030	25.4
30x72	60002-031	32.4	60007-031	32.4
30x84	60002-032	36.8	60007-032	36.8
30x96	60002-033	41.2	60007-033	41.2
30x120	60002-034	52.4	60007-034	52.4
30x144	60002-035	60.8	60007-035	60.8
36x48	60002-036	22.0	60007-036	22.0
36x60	60002-037	25.8	60007-037	25.8
36x72	60002-038	33.0	60007-038	33.0
36x84	60002-039	37.4	60007-039	37.4
36x96	60002-040	42.0	60007-040	42.0
36x120	60002-041	53.5	60007-041	53.5
36x144	60002-042	61.8	60007-042	61.8
42x48	60002-043	22.4	60007-043	22.4
42x60	60002-044	26.2	60007-044	26.2
42x72	60002-045	33.4	60007-045	33.4
42x84	60002-046	38.0	60007-046	38.0
42x96	60002-047	42.8	60007-047	42.8
42x120	60002-048	54.5	60007-048	54.5
42x144	60002-049	62.8	60007-049	62.8

FRAME (DxH)	PRE-WELDED	WEIGHT	TO-ASSEMBLE	WEIGHT
48x48	60002-050	23.0	60007-050	23.0
48x60	60002-051	27.0	60007-051	27.0
48x72	60002-052	34.4	60007-052	34.4
48x84	60002-053	39.0	60007-053	39.0
48x96	60002-054	44.0	60007-054	44.0
48x120	60002-055	57.0	60007-055	57.0
48x144	60002-056	64.0	60007-056	64.0



Beams



14 GA 3/4" STEP	BEAM	WEIGHT
48"	60006-001	8.3
60"	60006-002	10.0
72"	60006-003	11.9
84"	60006-004	16.7
96"	60006-005	15.5
108"	60006-006	17.3
120"	60006-007	19.1
14 GA 9/16" STEP	BEAM	WEIGHT
48"	60006-008	8.3
60"	60006-009	10.0
72"	60006-010	11.9
84"	60006-011	16.7
96"	60006-012	15.5
108"	60006-013	17.3
120"	60006-014	19.1
12 GA 3/4" STEP	BEAM	WEIGHT
48"	60006-015	10.9
60"	60006-016	13.4
72"	60006-017	15.8
84"	60006-018	18.3
96"	60006-019	20.8
108"	60006-020	23.3
120"	60006-021	25.8
12 GA 9/16" STEP	BEAM	WEIGHT
48"	60006-022	10.9
60"	60006-023	13.4
72"	60006-024	15.8
84"	60006-025	18.3
96"	60006-026	20.8
108"	60006-027	23.3
120"	60006-028	25.8

Deck Over and Flush Bottom Beams

14 GA 3/4" STEP	FLUSH BOTTOM BEAM	WEIGHT	DECK OVER BEAM	WEIGHT
48"	60006-029	8.3	60006-057	8.3
60"	60006-030	10.0	60006-058	10.0
72"	60006-031	11.9	60006-059	11.9
84"	60006-032	16.7	60006-060	16.7
96"	60006-033	15.5	60006-061	15.5
108"	60006-034	17.3	60006-062	17.3
120"	60006-035	19.1	60006-063	19.1
14 GA 9/16" STEP	FLUSH BOTTOM BEAM	WEIGHT	DECK OVER BEAM	WEIGHT
48"	60006-036	8.3	60006-064	8.3
60"	60006-037	10.0	60006-065	10.0
72"	60006-038	11.9	60006-066	11.9
84"	60006-039	16.7	60006-067	16.7
96"	60006-040	15.5	60006-068	15.5
108"	60006-041	17.3	60006-069	17.3
120"	60006-042	19.1	60006-070	19.1
12 GA 3/4" STEP	FLUSH BOTTOM BEAM	WEIGHT	DECK OVER BEAM	WEIGHT
48"	60006-043	10.9	60006-071	10.9
60"	60006-044	13.4	60006-072	13.4
72"	60006-045	15.8	60006-073	15.8
84"	60006-046	18.3	60006-074	18.3
96"	60006-047	20.8	60006-075	20.8
108"	60006-048	23.3	60006-076	23.3
120"	60006-049	25.8	60006-077	25.8
12 GA 9/16" STEP	FLUSH BOTTOM BEAM	WEIGHT	DECK OVER BEAM	WEIGHT
48"	60006-050	10.9	60006-078	10.9
60"	60006-051	13.4	60006-079	13.4
72"	60006-052	15.8	60006-080	15.8
84"	60006-053	18.3	60006-081	18.3
96"	60006-054	20.8	60006-082	20.8
108"	60006-055	23.3	60006-083	23.3
120"	60006-056	25.8	60006-084	25.8



Flush Bottom Beam



Deck Over Beam

Decking



DECKING (WxD)	CORRUGATED	FLAT STEEL	WIRE DECKING
48x12	60008-001	60021-001	60022-001
48x15	60008-002	60021-002	60022-002
48x18	60008-003	60021-003	60022-003
48x24	60008-004	60021-004	60022-004
48x30	60008-005	60021-005	60022-005
48x36	60008-006	60021-006	60022-006
48x42	60008-007	60021-007	60022-007
48x48	60008-008	60021-008	60022-008
60x12	60008-009	60021-009	60022-009
60x15	60008-010	60021-010	60022-010
60x18	60008-011	60021-011	60022-011
60x24	60008-012	60021-012	60022-012
60x30	60008-013	60021-013	60022-013
60x36	60008-014	60021-014	60022-014

DECKING (WxD)	CORRUGATED	FLAT STEEL	WIRE DECKING
60x42	60008-015	60021-015	60022-015
60x48	60008-016	60021-016	60022-016
72x12	60008-017	60021-017	60022-017
72x15	60008-018	60021-018	60022-018
72x18	60008-019	60021-019	60022-019
72x24	60008-020	60021-020	60022-020
72x30	60008-021	60021-021	60022-021
72x36	60008-022	60021-022	60022-022
72x42	60008-023	60021-023	60022-023
72x48	60008-024	60021-024	60022-024
84x12	60008-025	60021-025	60022-025
84x15	60008-026	60021-026	60022-026
84x18	60008-027	60021-027	60022-027
84x24	60008-028	60021-028	60022-028
84x30	60008-029	60021-029	60022-029
84x36	60008-030	60021-030	60022-030
84x42	60008-031	60021-031	60022-031
84x48	60008-032	60021-032	60022-032
96x12	60008-033	60021-033	60022-033
96x15	60008-034	60021-034	60022-034
96x18	60008-035	60021-035	60022-035
96x24	60008-036	60021-036	60022-036
96x30	60008-037	60021-037	60022-037
96x36	60008-038	60021-038	60022-038
96x42	60008-039	60021-039	60022-039
96x48	60008-040	60021-040	60022-040
108x12	60008-041	60021-041	60022-041
108x15	60008-042	60021-042	60022-042
108x18	60008-043	60021-043	60022-043
108x24	60008-044	60021-044	60022-044
108x30	60008-045	60021-045	60022-045
108x36	60008-046	60021-046	60022-046
108x42	60008-047	60021-047	60022-047
108x48	60008-048	60021-048	60022-048
120x12	60008-049	60021-049	60022-049
120x15	60008-050	60021-050	60022-050
120x18	60008-051	60021-051	60022-051
120x24	60008-052	60021-052	60022-052
120x30	60008-053	60021-053	60022-053
120x36	60008-054	60021-054	60022-054
120x42	60008-055	60021-055	60022-055
120x48	60008-056	60021-056	60022-056

B-Span Capacities

DIMENSIONS (DxW)	STANDARD DUTY 14 gauge (LBS)	HEAVY DUTY 12 gauge (LBS)
18x48	1,400	3,000
18x60	1,200	2,600
18x72	1,000	2,200
18x84	900	2,000
18x96	800	1,800
18x108	700	1,600
18x120	600	1,500
24x48	1,400	3,000
24x60	1,200	2,600
24x72	1,000	2,200
24x84	900	2,000
24x96	800	1,800
24x108	700	1,600
24x120	600	1,500
30x48	1,400	3,000
30x60	1,200	2,600
30x72	1,000	2,200
30x84	900	2,000
30x96	800	1,800
30x108	700	1,600
30x120	600	1,500
36x48	1,400	3,000
36x60	1,200	2,600
36x72	1,000	2,200
36x84	900	2,000
36x96	800	1,800
36x108	700	1,600
36x120	600	1,500
48x48	1,200	3,000
48x60	1,000	2,400
48x72	900	2,000
48x84	800	1,800
48x96	700	1,500
48x108	600	1,200
48x120	500	1,000

Accessories

DEPTH	TIE SUPPORT 9/16" STEP	WEIGHT
12"	60016-000	1.3
15"	60016-001	1.6
18"	60016-002	1.9
24"	60016-003	2.5
30"	60016-004	2.6
36"	60016-005	3.9
42"	60016-006	4.6
48"	60016-007	5.2
DEPTH	TIE SUPPORT 3/4" STEP	WEIGHT
12"	60016-008	1.3
15"	60016-009	1.6
18"	60016-010	1.9
24"	60016-012	2.5
30"	60016-013	2.6
36"	60016-014	3.9
42"	60016-015	4.6
48"	60016-016	5.2
DEPTH	BACK TO BACK TIE	WEIGHT
3"	60005-008	10.2
6"	60005-010	11.2
DEPTH	WALL TIE	WEIGHT
3"	60005-012	10.2
	FOOTPLATE	WEIGHT
-	60055-000	0.7
	B-SPAN POST SPICE	WEIGHT
-	60054-062	1.5





#B504 Blue



#C386 Red



#065 Industrial Gray

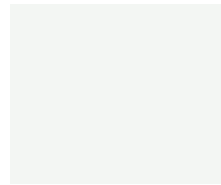

#445 White



#F604 Pebble



#161 Mist Gray



#040 Black

#045 Black

Borroughs Standard Powder Coat Colors

Borroughs powder coated finishes are high quality, durable and inert. Seven standard industrial (automotive) colors, available with no up-charge, are: #B504 Blue, #C386 Red, #065 Industrial Gray, #445 White, #F604 Pebble, #161 Mist Gray and #040 Black. We also offer custom color matching using Borroughs computerized technology.

Why Borroughs?

Because we know how important your storage system is to you and your organization. That's why we produce B-Span Shelving. Our shelving is value-engineered to provide strength, durability, flexibility and cost effective storage solutions. Shelving that will maximize your space utilization and needs today and tomorrow.

But Borroughs is more than shelving. During our 70+ years, we've also earned a reputation for outstanding service and responsive on-time delivery that we continue to work hard to maintain. Plus, Borroughs people are experienced and knowledgeable in storage planning and design. They have ideas and solutions to help your shelving system to continue to contribute to the efficiency of your company as it grows and changes.

You can count on the combination of Borroughs people and products to create the perfect storage solutions for all your needs.



3002 N. Burdick Street
Kalamazoo, MI 49004-3483
800-748-0227 · Fax 269-342-4161
www.borroughs.com

ISO 9001:2000 Registered
ISO 14001:2004 Registered