

QUANTUM MEDICAL

HEALTHCARE
STORAGE
SOLUTIONS



CALL US TODAY: 1-877-742-2467

VISIT US ONLINE: WWW.QUANTUMMEDICAL.COM

new PRODUCTS

We are always proud to bring our new and unique products that our customers need. Count on us for innovation and bringing you products and ideas that will improve and maximize your storage space.



Mesh Stack & Hang Bins
HIGH VISIBILITY! EASY TO CLEAN!
ALL WELDED!
pg. 10 & 92



STORE-MAX 8" Shelf Bins
LOW COST! LONG LASTING!
UNBREAKABLE! REUSABLE!
pg. 112



Post Basket
HIGH VISIBILITY! EASY TO CLEAN!
ALL WELDED!
pg. 50

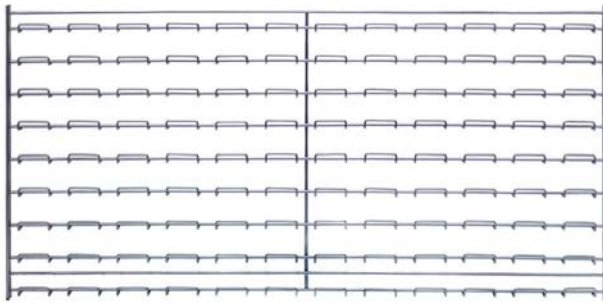

Wire Louvered Panels
HIGH VISIBILITY! EASY TO CLEAN!
ALL WELDED!
pg. 11 & 93



EZ Lock Platform & Pallet
EASILY STORE SUPPLIES & MATERIALS OFF THE
GROUND! QUICK & TROUBLE-FREE ASSEMBLY!
pg. 73

Healthcare Storage Solutions

LOW COST! LONG LASTING! UNBREAKABLE! REUSABLE!

Benefiting



PINK Stacking and Shelf Bins

Ultra Stack & Hang Bins



QUS210PK



QUS230PK



QUS240PK



QUS250PK

Economy Shelf Bins



QSB101PK



QSB102PK



QSB103PK



QSB104PK

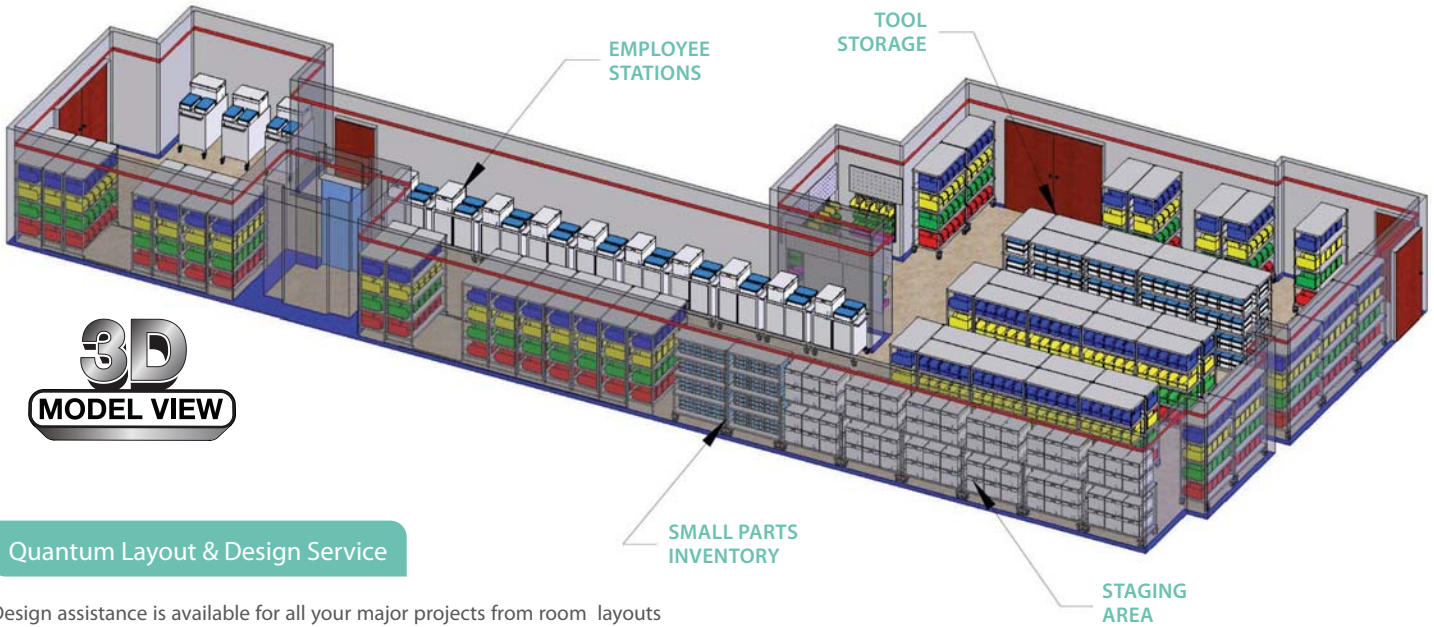

Quantum Layout & Design Service

Design assistance is available for all your major projects from room layouts to shelving or cart design. We'll create and develop an integrated system around your requirements. Layouts can be created to accommodate your space with the appropriate product mix consisting of:

- Wire Shelving
- Stationary Shelving
- Bins
- Wall Systems
- Baskets
- Containers
- Hi-Density Mobile Track Systems

TO ACHIEVE THE BEST RESULTS, PLEASE PROVIDE THE FOLLOWING INFORMATION:

- Room dimensions with door locations and door clearances, column locations (L x W) and ceiling height
- For shelving units, provide the number of shelf tiers, post height and indicate stationary or mobile
- If bins are required, indicate the appropriate size and whether they are to be used on shelving or wall mounted louvered panels

We offer the most complete package of storage products to satisfy all your requirements. Let us review your next project to maximize your storage space.

- Industry Exclusive 3D Modeling
- Blueprint & AutoCAD Compatible
- Space Utilization & Maximization
- Plan-o-grams

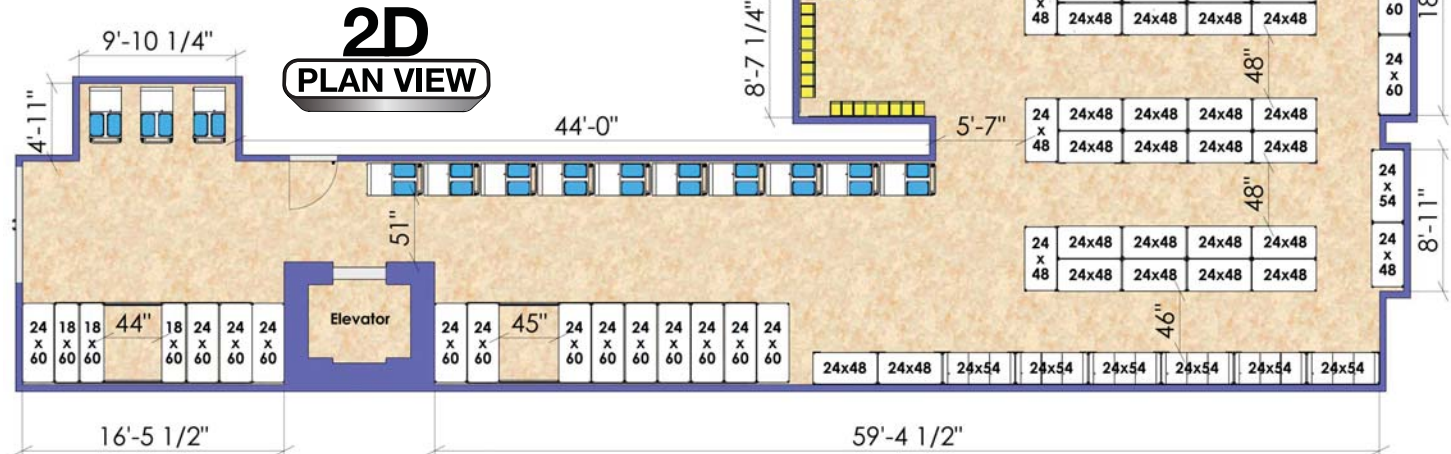

DESIGN ASSISTANCE Available!

TABLE OF CONTENTS

VERSA WALL

- 6 PARTition Wall Systems
- 7 PARTition Wall Systems
- 8 PARTition Wall Systems
- 9 PARTition Wall Systems - Accessories
- 10 Mesh Stack & Hang Bins
- 11 Wall Mount Wire Louvered Panels
- 12 Wall Mount Louvered Panels
- 13 Grid-Store Wall Mounted Systems
- 14 Wall Mount Cantilever Systems
- 15 Wall Mount Cantilever Packages

VERSA WORKS

- 16 PARTition Store
- 17 PARTition Store
- 18 PARTition Store Single Bay Carts
- 19 PARTition Store Double Bay Carts
- 20 PARTition Store - Accessories
- 21 High Density Storage Carts
- 22 High Density Racks
- 23 High Density Racks & Accessories

VERSA STORE

- 24 Medical Carts
- 25 Medical Carts
- 26 Medical Carts
- 27 Medical Carts
- 28 Medical Supply Carts
- 29 Medical Supply Carts
- 30 Medical Supply Carts & Cabinets
- 31 Medical Supply Cabinets

VERSA COMPLIMENTS

- 32 Utility Carts - Wire
- 33 Utility Carts - Polymer
- 34 Hamper & Sterile Wrap Carts
- 35 Surgical Case Carts & Tables
- 36 Bin Transport Carts

WIRE

- 37 Labels
- 38 Wire Shelving
- 39 Shelving Posts & Solid Shelves
- 40 54" Wire Shelving Units
- 41 63" Wire Shelving Units
- 42 74" Wire Shelving Units
- 43 86" Wire Shelving Units
- 44 Stainless Steel Solid Shelving Units
- 45 Stainless Steel Solid Shelving Units
- 46 Galvanized Steel Solid Shelving Units
- 47 Galvanized Steel Solid Shelving Units
- 48 Modular Wire Stacking Baskets
- 49 Modular Wire Basket Units
- 50 Post Baskets & Mobile Units
- 51 Garment Racks / Patient Apparel Cart
- 52 4 Shelf Stem Caster Carts
- 53 5 Shelf Stem Caster Carts
- 54 4 Shelf Enclosure Carts
- 55 5 Shelf Enclosure Carts
- 56 4 Shelf Enclosure Carts
- 57 5 Shelf Enclosure Carts
- 58 4 Shelf Linen Carts
- 59 5 Shelf Linen Carts
- 60 Security Units
- 61 Cart Covers
- 62 Slanted Shelf Carts
- 63 Slanted Shelf Carts
- 64 High Density Wire Systems
- 65 Catheter Carts
- 66 Bin Carts
- 67 Double & Triple Bay Bin Carts
- 68 High Density Sliding Track System
- 69 High Density Sliding Track System
- 70 Sliding Top Track System

- 71 Sliding Top Track System
- 72 Dunnage & Platform Racks
- 73 Dunnage & Platform Racks
- 74 Cafeteria Trays and Tray Carts
- 75 Wire Shelving - Accessories
- 76 Wire Shelving - Accessories
- 77 Wire Shelving - Accessories
- 78 Wire Shelving - Accessories
- 79 Wire Shelving - Accessories

BINS

- 80 Clear-View Ultra Stack and Hang Bins
- 81 Clear-View HULK 24" Containers
- 82 Clear-View Dividable Grid Containers
- 83 Clear-View Giant Stack & Stock Bins
- 84 Clear-View Economy Shelf Bins
- 85 Clear-View STORE-MORE 6" Shelf Bins
- 86 Clear-View STORE-MAX 8" Shelf Bins
- 87 Labels
- 88 Ultra Stack and Hang Bins
- 89 Ultra Stack and Hang Bins
- 90 Ultra Stack and Hang Bins
- 91 Ultra Stack and Hang Wire Shelving Systems
- 92 Mesh Stack & Hang Bins
- 93 Wall Mount Wire Louvered Panels
- 94 Wall Mount Louvered Panels
- 95 Hanging Rail Systems
- 96 Stackable Shelf Bins
- 97 Stackable Shelf Bin Wire Shelving Systems
- 98 Hulk 24" Containers
- 99 Hulk 24" Container Wire Shelving Systems
- 100 Hulk 30" & 36" Containers
- 101 Hulk 30" Container Wire Shelving Systems
- 102 Hulk 36" Container Wire Shelving Systems
- 103 Rackbin 42" Containers and Wire Shelving Systems
- 104 Giant Stack & Stock Containers
- 105 Giant Stack & Stock Container Wire Shelving Systems
- 106 Magnum Bins
- 107 Magnum Bin Wire Shelving Systems
- 108 Economy Shelf Bins
- 109 Economy Shelf Bin Wire Shelving Systems
- 110 STORE-MORE 6" Shelf Bins
- 111 STORE-MORE 6" Shelf Bin Wire Shelving Systems
- 112 STORE-MAX 8" Shelf Bins
- 113 STORE-MAX 8" Shelf Bin Wire Shelving Systems
- 114 QuickPick Bins
- 115 QuickPick Bin Wire Shelving Systems
- 116 Super Tuff Euro Drawers
- 117 Dividable Grid Containers
- 118 Genuine Stack and Nest Totes
- 119 Wire Shelving Systems
- 120 Cross Stack Tubs and Quantub
- 121 Tub Racks
- 122 Attached Top Distribution Containers
- 123 First Aid Caddy / Computer Work Center
- 124 Clear Tip Out Bin Systems
- 125 Clear Tip Out Bin Systems
- 126 Clear Tip Out Bin Floor Stands
- 127 Mobile Clear Tip Out Bin Floor Stands
- 128 Clear Tip Out Bin Rails & Frames
- 129 Free Standing & Gondola Slider Systems

FACILITIES STORAGE

- 130 Interlocking Storage Cabinets
- 131 Polymer Utility Carts & Tool Caddy
- 132 Heavy-Duty 36" Wide All-Welded Cabinets
- 133 Heavy-Duty 36" and 60" Wide Specialty Cabinets
- 134 Heavy-Duty 48" Wide All-Welded Cabinets
- 135 Work Benches
- 136 Bulk Storage Racks
- 137 Open & Closed Steel Shelving
- 138 Steel Shelving Systems
- 139 Steel Shelving Systems
- 140 HULK 24" Container Steel Shelving Systems
- 141 Super Tuff Euro Drawers Shelving Systems

- 142 Shelf Bin Steel Shelving Systems
- 143 Economy Shelf Bin Sloped Shelving Systems
- 144 Ultra Stack and Hang Complete Package Units

- 145 Index
- 146 Index
- 147 Index



We offer you the largest selection of bins, totes, and complete storage solutions in the industry. Our plastic storage products range from small parts and high density storage to extra large stackable containers used to organize and sort your heavy-duty or bulky items. Our vast line specializes in unique instrument storage as well as NSF approved storage systems. Whether your requirement is for our new clear storage bins or mobile transport carts, we can fulfill your every need.

With over 25 years of experience, we are healthcare's 'go to' for professional and complete storage solutions. We strive to provide more than just quality products and services. We would like to be your partner for all design and organizational opportunities. Reach out to us today and let us show you our full range of services and products.

Your partner for Healthcare Storage Solutions!

VERSA WALL



Partition Wall Systems
6



Partition Wall Systems
8



Mesh Stack & Hang Bins
10



Wall Mount Wire Louvered Panels
11



Wall Mount Louvered Panels
12



Grid-Store Wall Mounted Systems
13



Wall Mount Cantilever Systems
14



Wall Mount Cantilever Packages
15

VERSA WORKS



PARTition Store
16



PARTition Store
17



Partition Store Single Bay Carts
18



PARTition Store Double Bay Carts
19



PARTition Store - Accessories
20



High Density Storage Carts
21



High Density Racks
22



High Density Racks & Accessories
23

VERSA STORE



Aluminum Crash Cart
24



Economy Cart
24



Isolation Cart
25



Aluminum Bedside Cart
26



Aluminum Auto-Locking Cart
27



Aluminum Carts
27



Medical Supply Carts
28



Medical Supply Cabinets
31

VERSA COMPLIMENTS



Utility Wire Carts
32



Utility Plastic Carts
33



Hamper
34



Sterile Wrap Carts
34



Surgical Case Carts
35



Stainless Steel Work Tables
35



Bin Transport Carts
36



Transport Cart
36

WIRE



Shelving
38



Modular Wire Stacking Baskets
48



Garment Racks / Patient Apparel Cart
51



Wire & Solid Shelf Carts
58



High Density Sliding Track System
68



Sliding Top Track System
70



Cafeteria Trays & Tray Carts
72



Dunnage & Platform Racks
74

BINS



Clear-View Bins & Systems
80



Ultra Stack & Hang Bins & Systems
88



Stackable Shelf Bins & Systems
96



HULK Containers & Systems
98



RACKBIN & Systems
103



Giant Stack & Stock Containers & Systems
104



Magnum Bins & Systems
106



Shelf Bins & Systems
108



QuickPick Bins & Systems
114



Euro Drawers & Systems
116



Dividable Grid Containers
117



Stack & Nest Totes
118



Cross Stack Tubs
120



Attached Top Distribution Containers
122



First Aid Caddy / PC Work Center
123



Clear Tip Out Bin Systems
124

FACILITIES STORAGE



Interlocking Storage Cabinets & Stands
130



Polymer Utility Carts & Tool Caddy
131



Heavy-Duty Cabinets
132



Work Benches
135



Bulk Storage Racks
136



Open & Closed Steel Shelving
137



Steel Shelving Systems
138



Ultra Stack & Hang Complete Units
144



PARtition Wall Systems

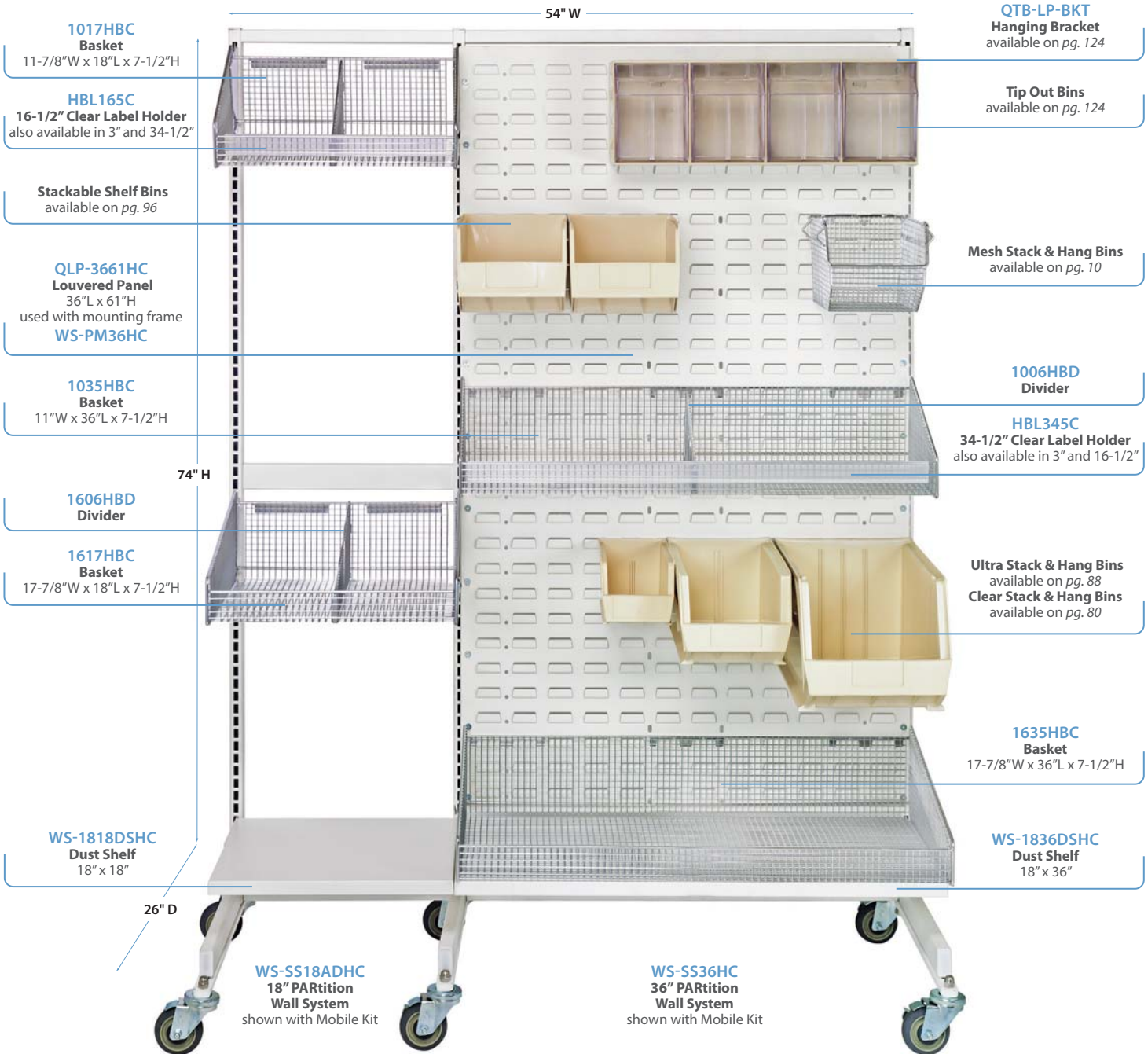

INSTANT VISIBILITY! EASY TO CLEAN! ALL WELDED!



QTB-LP-BKT
Hanging Bracket for Tip Out Bins



All Starter and Add-On Units come standard with Leg Levelers



All Starter and Add-On Units can be made mobile

Mobilize your units by ordering the following:

- | | |
|---------------------------------|---------------------------------|
| Single Sided Starter Kit | Double Sided Starter Kit |
| 2 - WS-SSMOB Bar | 2 - WS-DSMOB Bar |
| 2 - WS-MOB Caster Kit | 2 - WS-MOB Caster Kit |
| Single Sided Add-On Kit | Double Sided Add-On Kit |
| 1 - WS-SSMOB Bar | 1 - WS-DSMOB Bar |
| 1 - WS-MOB Caster Kit | 1 - WS-MOB Caster Kit |



Starter Units

Starter units come complete with two uprights and three tie-bars.



WS-SS18HC WS-SS36HC WS-SS48HC

Add-On Units

Add-On units allow you to expand your Starter unit by sharing an upright. Add-On unit includes one common upright and three tie-bars.

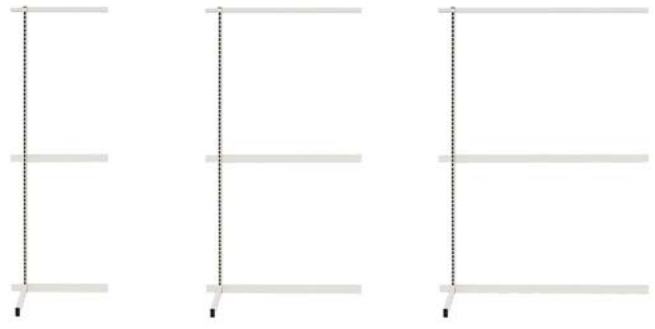

WS-SS18ADHC WS-SS36ADHC WS-SS48ADHC

STARTER UNIT					ADD-ON					ACCESSORIES				
L"	MODEL NO.	SHIP WGT	MODEL NO.	SHIP WGT	HANG BAR	12" DUST SHELF	18" DUST SHELF	LOUVERED PANEL	PANEL FRAME					
L"	MODEL NO.	SHIP WGT	MODEL NO.	SHIP WGT	MODEL NO.	MODEL NO.	MODEL NO.	MODEL NO.	MODEL NO.					
Single Side Unit														
18"	WS-SS18HC	31 lbs	WS-SS18ADHC	19 lbs	-	WS-1218DSHC	WS-1818DSHC	QLP-1861HC	WS-PM18HC					
36"	WS-SS36HC	37 lbs	WS-SS36ADHC	25 lbs	WS-HB36HC	WS-1236DSHC	WS-1836DSHC	QLP-3661HC	WS-PM36HC					
48"	WS-SS48HC	42 lbs	WS-SS48ADHC	30 lbs	WS-HB48HC	WS-1248DSHC	WS-1848DSHC	QLP-4861HC	WS-PM48HC					
Double Side Unit														
18"	WS-DS18HC	34 lbs	WS-DS18ADHC	21 lbs	-	WS-1218DSHC	WS-1818DSHC	QLP-1861HC	WS-PM18HC					
36"	WS-DS36HC	40 lbs	WS-DS36ADHC	27 lbs	WS-HB36HC	WS-1236DSHC	WS-1836DSHC	QLP-3661HC	WS-PM36HC					
48"	WS-DS48HC	45 lbs	WS-DS48ADHC	32 lbs	WS-HB48HC	WS-1248DSHC	WS-1848DSHC	QLP-4861HC	WS-PM48HC					

CUSTOMIZE YOUR OWN UNIT!

For Units using Hanging Brackets:

- Determine total space you want to fill from left to right
- Select a Starter Unit (either 18" or 36" wide)
- Fill remaining space by utilizing Add-On Units
- Determine how many basket levels you want to have per unit, which will correspond to the total number of brackets needed
- Dividers and label holders are available for all basket sizes

For Units using Louvered Panels:

- Determine total space you want to fill from left to right
- Select a Starter Unit (either 18", 36" or 48" wide)
- Fill remaining space by utilizing Add-On Units
- Each unit (both Starter or Add-On) will fit a corresponding 18", 36" or 48" louvered panel (note: Louvered panel requires one panel frame)
- Louvered panel will accommodate:
 - Hanging Baskets - available on pg. 9
 - Clear Tip Out Bins - available on pg. 124 (note: one hanging bracket pair QTBLP-BKT is needed per Tip Out Bin)
 - Mesh Bins - available on pg. 10
 - Plastic Bins - available on pg. 80, 88 & 96 (see chart on the bottom of pg. 12 to determine quantity of bins that fit on panel)

Hanging Baskets

- 125 lb. load capacity per basket (up to twice as strong as plastic bins)
- Mesh design ensures no accumulation of dirt or dust and instant visibility
- Brilliant chrome finish ensures professional appearance and years of heavy-duty service
- Baskets can be divided allowing maximization of all space



WS-DS36HC
Shown with Baskets
(Sold separately)

MODEL NO.	OUTSIDE DIMENSIONS W" x L" x H"	INSIDE DIMENSIONS W" x L" x H"
Hanging Baskets		
1017HBC	11-7/8" x 18" x 7-1/2"	11" x 17-3/8" x 7"
1035HBC	11-7/8" x 36" x 7-1/2"	11" x 35" x 7"
1617HBC	17-7/8" x 18" x 7-1/2"	17" x 17-3/8" x 7"
1635HBC	17-7/8" x 36" x 7-1/2"	17" x 35" x 7"

UNIQUELY DESIGNED
for high visibility & easy access!



1017HBC



1035HBC



1617HBC

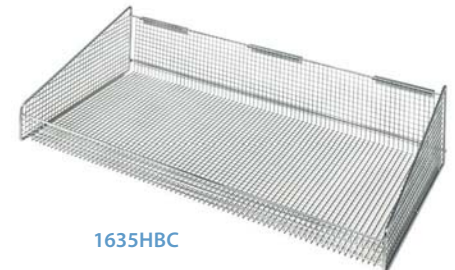

1635HBC

CHOOSE YOUR IDEAL position

FIRST POSITION
8° slope



SECOND POSITION
10° slope



THIRD POSITION
30° slope



3 DIVIDERS
Included per 18" basket

5 DIVIDERS
Included per 36" basket



WS-SS36-4S3L

COMPLETE PACKAGES
with hanging baskets with dividers,
full width label holders and dust shelf!

PARtition Wall Systems - Complete Packages

PARtition Wall Hanging Baskets are uniquely designed for instant visibility and easy access while maximizing your wall storage area. The wire construction minimizes dirt accumulation and allows air circulation. Baskets have a dividable grid pattern to partition product while letting you know when to reorder product and restock items. Available in 11-7/8" and 17-7/8" widths, and in 18" and 36" lengths. **Finish:** Chrome

MODEL NO.	NO. OF BASKETS	BASKET MODEL NO.	NO. OF DIVIDERS	DIVIDER MODEL NO.	NO. OF LABEL HOLDERS	DUST SHELF MODEL NO.
18" Single Sided Systems - Complete with Baskets, Dividers, Label Holders and Dust Shelf						
WS-SS18-7S	7	1017HBC	21	1006DHB	7	WS-1218DSHC
WS-SS18-4S3L	4	1017HBC	12	1006DHB	7	WS-1818DSHC
	3	1617HBC	9	1606DHB	7	
36" Single Sided Systems - Complete with Baskets, Dividers, Label Holders and Dust Shelf						
WS-SS36-7S	7	1035HBC	35	1006DHB	7	WS-1236DSHC
WS-SS36-4S3L	4	1035HBC	20	1006DHB	7	WS-1836DSHC
	3	1635HBC	15	1606DHB	7	



Dividers

2 SIZES AVAILABLE!

Separate product in basket with use of optional dividers. Dividers are used front to back to create individual compartments.

MODEL NO.	DIMENSIONS W" x H"	SHIP WGT
Hanging Basket Dividers		
1006DHB	10" x 6"	1 lb
1606DHB	16" x 6"	2 lbs

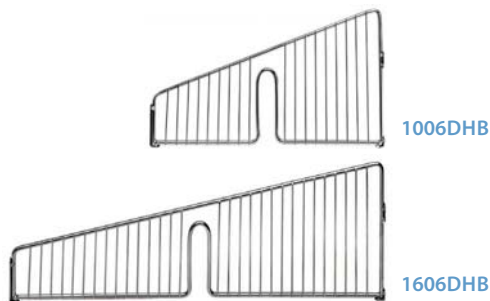

Clear Label Holders

A user friendly method for identifying product. Affixes directly to the front on any basket. Three lengths available.

MODEL NO.	DESCRIPTION	SHIP WGT
Clear Label Holders		
HBL3C	3" Clear Label Holder	1 lb
HBL165C	16-1/2" Clear Label Holder	1 lb
HBL345C	34-1/2" Clear Label Holder	1 lb



HBL165C

Dust Shelves

MODEL NO.	DIMENSIONS W" x L"	SHIP WGT
Dust Shelves		
WS-1218DSHC	12" x 18"	5 lbs
WS-1236DSHC	12" x 36"	10 lbs
WS-1248DSHC	12" x 48"	15 lbs
WS-1818DSHC	18" x 18"	7 lbs
WS-1836DSHC	18" x 36"	15 lbs
WS-1848DSHC	18" x 48"	20 lbs

* Dust Shelves not designed for load bearing



WS-1218DSHC

Spikes and Holders



WS-HTH
Horizontal Tape/Reel Holder

WS-VTH
Vertical Tape/Reel Holder

WS-SR9C
9" Single Rod

WR-DR10C
10" Double Rod

WS-HDS6
Heavy-Duty 6" Spike

WS-HDS12
Heavy-Duty 12" Spike

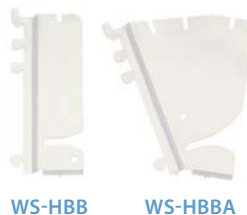

WS-HBB

WS-HBBA

Hanging Brackets

MODEL NO.	DESCRIPTION	SHIP WGT
Hanging Brackets		
WS-HBB	90° Bracket Pair (2 pcs)	1 lb
WS-HBBA	Adjustable Bracket Pair (2 pcs)	1 lb

Louvered Panels

MODEL NO.	DIMENSIONS L" x H"	SHIP WGT
Oyster White Louvered Panels		
QLP-1861HC	18" x 61"	21 lbs
QLP-3661HC	36" x 61"	40 lbs
QLP-4861HC	48" x 61"	60 lbs

* Louvered Panels require frame in order to affix to PARTition Wall Systems



WS-HB36HC

Hang Bars

Used to mount wire louvered panels on PARTition Wall Systems.

MODEL NO.	DESCRIPTION	SHIP WGT
Hang Bars		
WS-HB36HC	36" Hang Bar	4 lbs
WS-HB48HC	48" Hang Bar	5 lbs



QLP-4861HC

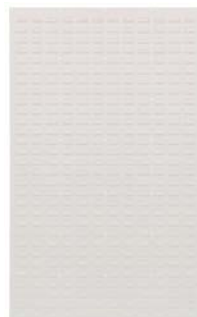

QLP-3661HC



QLP-1861HC



Exclusive! Mesh Stack & Hang Bins



New patented Wire Mesh Bins are an industry exclusive. Our innovative mesh design offers a nickel-chrome finish and a 3/8" x 3/8" grid pattern allowing complete visibility of the bin's contents. This unique mesh pattern provides a dust and dirt free storage environment. Ultra strong design allows for superior hang capacity perfect for IV fluid storage or anything where hang capacities are vital. Available in 9 popular sizes, Quantum's Mesh Bins stack one on top of the other and feature a rear hanger that allows them to hang from any louvered wall panel or rail system. The open hopper design allows for easy picking while allowing visual access to stored contents. Two optional label holders are available for all Mesh Bins. **Finish:** Chrome

CHROME MODEL NO.	OUTSIDE DIMENSIONS L" x W" x H"	INSIDE DIMENSIONS L" x W" x H"	CTN QTY	CTN WGT
QMB510C	5-1/4" x 4-1/4" x 3"	4-3/4" x 4" x 2-7/8"	20	12 lbs
QMB520C	7-1/4" x 4-1/4" x 3"	6-3/4" x 4" x 2-7/8"	20	15 lbs
QMB530C	10-3/4" x 5-1/2" x 5"	10-1/4" x 5-1/2" x 4-3/4"	10	12 lbs
QMB535C	10-3/4" x 11" x 5"	10-1/4" x 10-3/4" x 4-3/4"	10	19 lbs
QMB539C	10-1/2" x 8" x 7"	10" x 7-1/2" x 6-3/4"	10	20 lbs
QMB540C	14-1/2" x 8" x 7"	14" x 7-2/5" x 6-3/4"	10	30 lbs
QMB550C	14-1/2" x 16-1/4" x 7"	14" x 15-3/4" x 6-3/4"	5	17 lbs
QMB560C	18-1/2" x 11" x 10-1/4"	18" x 10-5/8" x 10"	5	21 lbs
QMB570C	18-1/2" x 17" x 11-1/4"	18" x 16-5/8" x 11"	5	28 lbs

new



HIGH VISIBILITY!
EASY TO CLEAN!
ALL WELDED!
Mesh Bins!



QMB560C Mesh Bin Stacked

9 SIZES AVAILABLE!



QMB510C



QMB520C



QMB530C



QMB535C



QMB539C



QMB540C



QMB550C



QMB560C



QMB570C



QMB539C Shown with optional HBL3C Label Holder Clear (Sold separately)

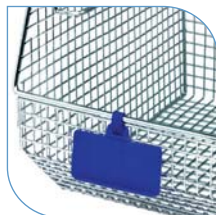

QMB539C Shown with optional PS-LH3 Hanging Label Tag Clear, Red, Yellow, Blue and Green (Sold separately)



OUTWARD PIVOTING ARM
Allows full use and visibility of the entire bin



REAR HANGER
All mesh bins have a super strong rear hanger that allows hanging from a louvered panel or rail system

INWARD PIVOTING ARM
Provides a flat stable surface enabling the bins to stack

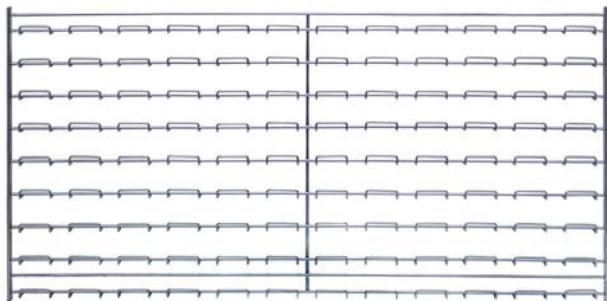

WLP-1836C
36" L x 18" H
Accepts all sizes of Ultra Stack & Hang Bins and Mesh Bins. Includes 8 direct mount clips. 175 lb. load capacity.



WLP-3036C
36" L x 30" H
Accepts all sizes of Ultra Stack & Hang Bins and Mesh Bins. Includes 12 direct mount clips. (Bins sold separately)

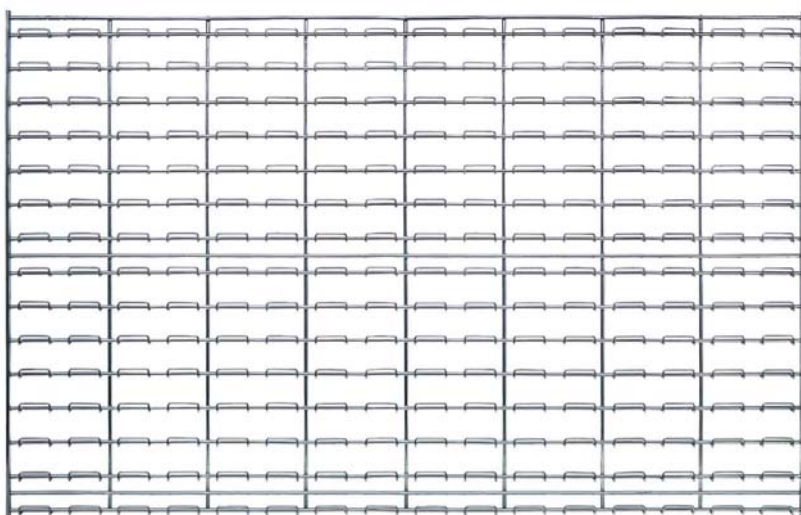

new

Exclusive! Wire Louvered Panels



Quantum's new chrome wire louvered panels offer a perfect mounting solution for all plastic hanging and new wire mesh hanging bins. Unlike a standard louvered panel where there can be the occasional concern of dust or dirt accumulation, Quantum's exclusive offering of wire panels, available in three sizes, completely resist any buildup of dust or dirt. Included direct mounting clips enable fastening to any surface (wall, wood, concrete, drywall, etc.) a snap (note: mounting screws are not included as they differ based on what type of surface the panels are being mounted to). Offset mounting clips are also available, can be used in place of WLP-DMC if you want to have wire panel mounted offset (away) from a wall surface making it easier to clean behind the panel (sold separately). Manufactured of heavy-duty chrome wire, Quantum's wire panels will offer years of dependable and heavy-duty service.

MODEL NO.	DIMENSIONS L" x H"	CTN QTY	CTN WGT
Wire Wall Mounted Louvered Panels			
WLP-1836C	36" x 18" Wire Louvered Panel	1	12 lbs
WLP-3036C	36" x 30" Wire Louvered Panel	1	19 lbs
WLP-3048C	48" x 30" Wire Louvered Panel	1	26 lbs

Accessories

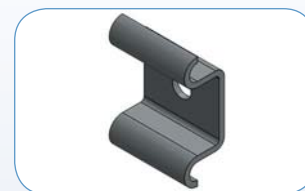

WLP-DMC
Direct Mount Clips - 4 pack
(Included with wire louvered panels)

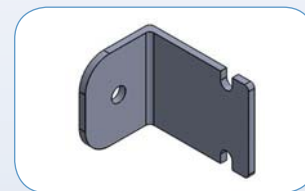

WLP-OSC
Offset Mount Clips - 4 pack
(Sold separately)

WLP-3048C
48" L x 30" H
Accepts all sizes of Ultra Stack & Hang Bins and Mesh Bins. Includes 12 direct mount clips. 175 lb. load capacity.

**HIGH VISIBILITY!
EASY TO CLEAN!
ALL WELDED!**

QUANTITY OF MESH BINS TO FIT LOUVERED PANELS

QUANTITY OF ULTRA BINS TO FIT LOUVERED PANELS

MODEL NO.	QMB 510	QMB 520	QMB 530	QMB 535	QMB 539	QMB 540	QMB 550	QMB 560	QMB 570	QUS 200	QUS 210	QUS 220	QUS 221	QUS 224	QUS 230	QUS 234	QUS 235	QUS 239	QUS 240	QUS 241	QUS 242	QUS 245	QUS 250	QUS 255	QUS 260	QUS 265	QUS 270
WLP-1836C	32	32	18	9	8	8	4	3	2	32	32	32	18	18	18	18	9	8	8	8	8	6	4	6	3	4	2
WLP-3036C	56	56	30	15	16	16	6	6	6	56	56	56	30	30	30	30	15	16	16	16	16	10	6	9	6	8	6
WLP-3048C	77	77	40	20	20	20	8	12	6	77	77	77	40	40	40	40	20	20	20	20	20	10	8	12	12	15	6

See pg. 10 & 88 for bin dimensions.



Ultra Hanging Louvered Panels

Quantum Ultra Bins will hang on louvered panels in a wide range of configurations designed to meet all application needs. Use the system best suited to your needs with your choice of Ultra Bins. Systems are formed from heavy-duty 16 gauge cold rolled steel and have a Oyster White or Gray baked-enamel finish which ensures years of heavy-duty use. Louvered panels may be mounted on any suitable wall surface. Fasten securely to assure adequate load bearing.



QLP-1819HC
18"L x 19"H

Accepts all sizes of Ultra Bins.
175 lb. load capacity.
(Bins sold separately)



QLP-3619HC
36"L x 19"H

Accepts all sizes of Ultra Bins.
175 lb. load capacity.
(Bins sold separately)



QLP-1861HC
18"L x 61"H

Accepts all sizes of Ultra Bins.
250 lb. load capacity.
(Bins sold separately)



QLP-3661HC
36"L x 61"H

Accepts all sizes of Ultra Bins.
500 lbs. load capacity. (Bins sold separately)

MODEL NO.	DIMENSIONS L" x H"	CTN QTY	CTN WGT
Oyster White Wall Mounted Louvered Panels			
QLP-1819HC	18" x 19" Oyster White Louvered Panel	1	6 lbs
QLP-1861HC	18" x 61" Oyster White Louvered Panel	1	21 lbs
QLP-3619HC	36" x 19" Oyster White Louvered Panel	1	13 lbs
QLP-3661HC	36" x 61" Oyster White Louvered Panel	1	40 lbs
QLP-4861HC	48" x 61" Oyster White Louvered Panel	1	60 lbs
Gray Wall Mounted Louvered Panels			
QLP-1819	18" x 19" Gray Louvered Panel	1	6 lbs
QLP-1861	18" x 61" Gray Louvered Panel	1	21 lbs
QLP-2721	27" x 21" Gray Louvered Panel	1	11 lbs
QLP-3612	36" x 12" Gray Louvered Panel	1	8 lbs
QLP-3619	36" x 19" Gray Louvered Panel	1	13 lbs
QLP-3661	36" x 61" Gray Louvered Panel	1	40 lbs
QLP-4819	48" x 19" Gray Louvered Panel	1	18 lbs
QLP-4861	48" x 61" Gray Louvered Panel	1	60 lbs

OYSTER WHITE OR GRAY
color!

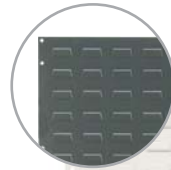

QLP-4861HC
48"L x 61"H

Accepts all sizes of Ultra Bins.
500 lbs. load capacity. (Bins sold separately)

QUANTITY OF ULTRA BINS TO FIT LOUVERED PANELS

MODEL NO.	QUS 200	QUS 210	QUS 220	QUS 221	QUS 224	QUS 230	QUS 234	QUS 235	QUS 239	QUS 240	QUS 241	QUS 242	QUS 245	QUS 250	QUS 255	QUS 260	QUS 265	QUS 270
QLP-1819	16	16	16	9	12	9	9	3	4	4	4	4	3	2	1	1	4	1
QLP-1861	60	60	60	30	30	30	30	15	14	14	14	14	10	7	7	5	12	5
QLP-2721	30	30	30	12	12	12	12	6	6	6	6	6	3	2	4	4	6	1
QLP-3612	18	18	18	12	12	12	12	6	4	4	4	4	4	2	6	3	8	2
QLP-3619	40	40	40	18	24	18	18	9	8	8	8	8	6	4	6	3	8	2
QLP-3661	120	120	120	60	80	60	60	30	28	28	28	28	20	14	21	15	24	10
QLP-4819	55	55	55	24	24	24	24	12	10	10	10	10	6	4	8	8	10	2
QLP-4861	165	165	165	80	80	80	80	40	35	35	35	35	20	14	28	20	30	10

See pg. 88 for bin dimensions.



Grid-Store Wall Mounted Systems

Grid-Store System provides a strong, versatile solution for organization and storage of small, medium and large supplies. A wide selection of accessories allow for easy storage of items ranging from catheters to crutches. Heavy-duty wall brackets firmly secure panels to walls or any flat surface. Heavy gauge wire grid (1/4" rod) construction allows for secure storage as well as visibility and dust and dirt free storage. Durable white gloss finish is aesthetically pleasing. Grid hooks and accessories are fabricated using 1/4" diameter wire, allowing heavy-duty application storage.

GRID-STORE HOOKS

Each hook is a full 1/4" in diameter and ideal for hanging prepackaged items. Available in 2 lengths.

GRID-STORE HOOK TUBE WITH 5 HOOKS

16" Rectangular tubing with 5 hooks.

GRID-STORE SLANTED SHELF

Slanted shelf allows you to display products higher up yet still easy to see. Measures 15-1/4"L x 22-3/8"W.

GRID-STORE BASKETS

12"L x 12"W x 8"H baskets, one also available with a 4" front lip allowing easy access to items stored.

MODEL NO.	DESCRIPTION	CTN QTY	CTN WGT
Grid Panels			
GSP-2448	24" x 48" Grid-Store Panel	1	12 lbs
A GSP-2460	24" x 60" Grid-Store Panel	1	15 lbs
GSP-2472	24" x 72" Grid-Store Panel	1	17 lbs
Grid Panels Accessories			
B GSP-HOOK6	6" Grid-Store Hook	1	1 lb
GSP-HOOK10	10" Grid-Store Hook	1	1 lb
C GSP-B12128	12" x 12" x 8" Grid-Store Basket	1	3 lbs
D GSP-5HOOK-16	16" Rectangular Tube w/ 5 Hooks	1	2 lbs
E GSP-WMHD	Heavy-Duty Wall Mounting Bracket	1	1 lb
F GSP-SB12128	12" x 12" x 8" Slanted Grid-Store Basket	1	2 lbs
G GSP-SS2215	22-3/8" x 15-1/4" Slanted Shelf	1	4 lbs

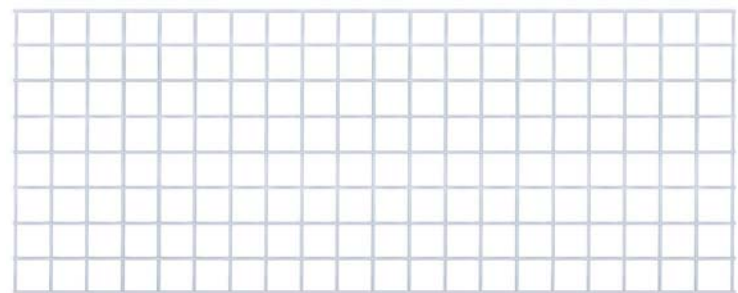
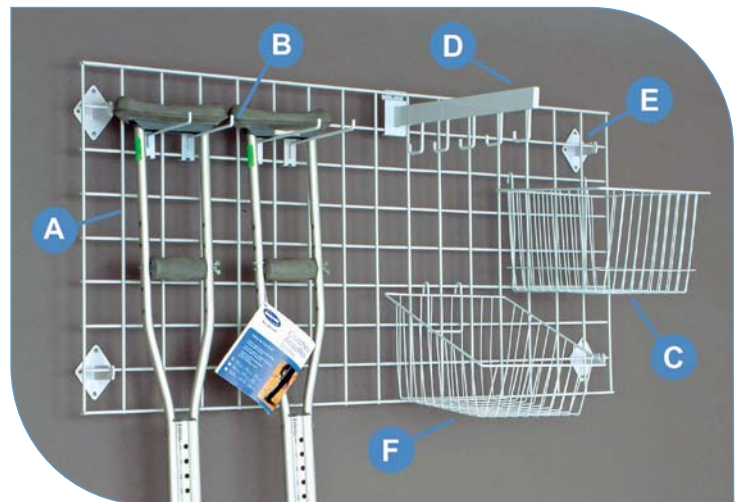

GSP-2448

A

Accessories

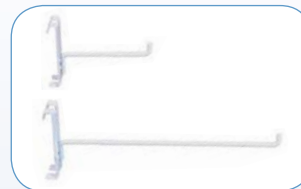

B GSP-Hooks 6" and 10"



C GSP-B12128



D GSP-5HOOK-16



E GSP-WMHD



F GSP-SB12128

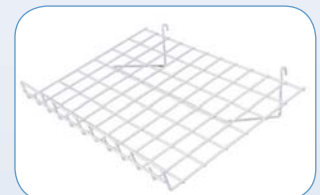

G GSP-SS2215

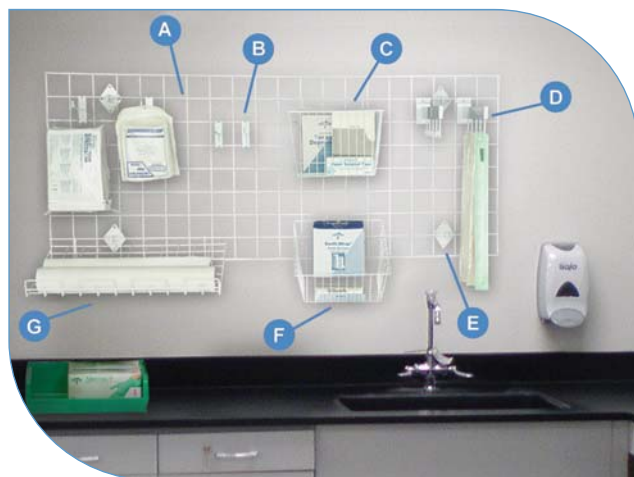

STRONG & VERSATILE SOLUTION
for small, medium and large supplies!



Cantilever Single Shelf Wall Mount

Cantilever shelving is an excellent way to create storage space when floor space isn't available. Simple in design, our cantilever shelving systems are easy to assemble and install. Cantilever Arm is available in 14", 18" and 24" depths. Two cantilever arms and 2 mounting brackets are included per order. Chrome wire shelves are sold separately and are available on pg. 38.

MODEL NO.	DESCRIPTION	SHIP WGT
DWB14	2 - 14" cantilever arms & 2 mounting brackets	3 lbs
DWB18	2 - 18" cantilever arms & 2 mounting brackets	4 lbs
DWB24	2 - 24" cantilever arms & 2 mounting brackets	5 lbs



MOUNTING BRACKET
DWB14, DWB18 or DWB24
Wire Cantilever Arm

Cantilever Multiple Shelf Post Wall Mount
Adjustable on 1" increments

Adjustable post wall mount systems use a post cantilever single arm of 14", 18" or 24" with appropriate shelf size and post height. Two post cantilever single arms and 4 post mount brackets are included per order.

Post Cantilever Double Arm is available in 14", 18" and 24" and uses the center post for continuous or add-on shelf sections. One post cantilever double arm and 2 post mount brackets are included per order. Wire shelves and post are sold separately and available on pg. 38 & 39.

MODEL NO.	DESCRIPTION	SHIP WGT
Single Post Cantilever Arms		
CB14	2 - 14" single post cantilever arms & 4 post mount brackets	5 lbs
CB18	2 - 18" single post cantilever arms & 4 post mount brackets	6 lbs
CB24	2 - 24" single post cantilever arms & 4 post mount brackets	7 lbs
Double Post Cantilever Arms		
DCB14	1 - 14" double post cantilever arm & 2 post mount brackets	10 lbs
DCB18	1 - 18" double post cantilever arm & 2 post mount brackets	12 lbs
DCB24	1 - 24" double post cantilever arm & 2 post mount brackets	14 lbs

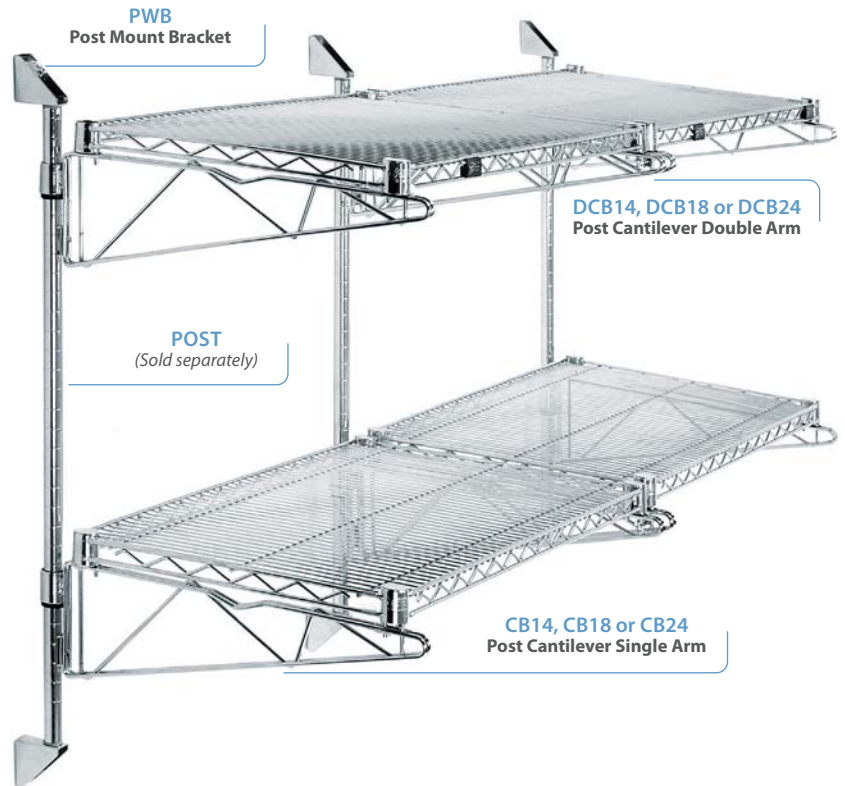

PWB
Post Mount Bracket
Used to secure cantilever post mount units and free standing shelving units to wall.
Sold in a pack of 4.
(Mounting Screws are not included)

TO ORDER THE ABOVE CONFIGURATION, YOU WOULD ORDER THE FOLLOWING:

- 2 - CB18
- 2 - DCB18
- 4 - 1836C
- 3 - P34C

To further extend the configuration shown by an additional section to the left or right, simply order:

- 2 - DCB18
- 2 - 1836C
- 1 - P34C

To further extend the configuration shown by an additional shelf level, simply order:

- 1 - CB18
- 1 - DCB18
- 2 - 1836C

Your options are unlimited!



Basket Dividers

Optional dividers can be used to separate product. **Finish:** Chrome

DIVIDER MODEL NO.	DIMENSIONS L" x H"	SHIP WGT
149DC	14" x 9"	1 lb
209DC	20" x 9"	2 lbs
2012DC	20" x 12"	2 lbs



Post Wall Mount Cantilever with Bin Holders Complete Packages

Easy access, adjustable wall mounted bin systems. Available in 36", 48" and 60" widths. Bins available in Blue, Green, Ivory, Red, Yellow, Black and Clear. Optional bin dividers, windows and clear label holders are available on pg. 88.

Available in: ●Blue ●Green ●Ivory ●Red ●Yellow ●Black ●Clear

MODEL NO.	NO. OF BIN HOLDERS	DIMENSIONS L" x H"	NO. OF BINS	BIN DIMENSIONS L" x W" x H"	SHIP WGT
Wire Cantilever Bin Holder -- Complete with Bins Available in Blue, Green, Ivory, Red, Yellow, Black and Clear					
CAN-34-36BH-230	3	36" x 34"	18 QUS230	10-7/8" x 5-1/2" x 5"	26 lbs
CAN-34-48BH-230	3	48" x 34"	24 QUS230	10-7/8" x 5-1/2" x 5"	34 lbs
CAN-34-60BH-230	3	60" x 34"	30 QUS230	10-7/8" x 5-1/2" x 5"	42 lbs

Post Wall Mount Cantilever with Baskets Complete Packages

Modular Wire Baskets mount to standard post to utilize wall space efficiently. Baskets allow for high visibility and quick accessibility. Baskets are adjustable and removable. **Finish:** Chrome

MODEL NO.	NO. OF BASKETS	BASKET MODEL NO.	BASKET DIMENSIONS W" x L" x H"	SHIP WGT
34"H Wire Cantilever with Baskets -- Complete Packages				
CAN-34-1436BC-PWB	2	1436BC	14" x 36" x 9"	26 lbs
CAN-34-1448BC-PWB	2	1448BC	14" x 48" x 9"	32 lbs
CAN-34-2036BC-PWB	2	2036BC	20" x 36" x 9"	30 lbs
CAN-34-2048BC-PWB	2	2048BC	20" x 48" x 9"	36 lbs
CAN-34-203612BC-PWB	2	203612BC	20" x 36" x 12"	34 lbs
CAN-34-204812BC-PWB	2	204812BC	20" x 48" x 12"	38 lbs

COMPLETE PACKAGES with bins!



COMPLETE PACKAGES with baskets!





PS-RSS
Red Safety Stop
Locks slanted baskets down TIGHT



PS-LH3
Hanging Label Tag
Clear, Red, Yellow, Blue and Green
3"W x 1-3/8"H



110%
accessible

PARTition Store Starter Unit

Starter units come complete with 2 frames, 4 cross bars, top wire shelf, full extension slides, bottom dust cover and four 4" H casters, 2 with brakes.



PS-S2475-8WB
Starter Unit with Wire Baskets
 24"D x 19-1/2"W x 75"H
 1 - 3" wire basket with 2 long & 2 short-dividers
 6 - 5" wire basket with 1 long & 2 short-dividers
 1 - 8" wire basket with 1 long & 1 short-divider
 1 - safety stop
 1 - bottom dust cover
 25 - PS-LH3 hanging label tags



PS-S2475-8PT
Starter Unit with Plastic Mesh Trays
 24"D x 19-1/2"W x 75"H
 7 - 4" trays with 1 Long & 2 Short-Dividers
 1 - 8" tray with 1 Long & 1 Short-Divider
 1 - safety stop
 1 - bottom dust cover



PS-S2475-7S
Starter Unit with Wire Shelves
 24"D x 19-1/2"W x 75"H
 7 - wire shelves on slides
 1 - bottom dust cover

PARTition Store Add-On Unit

Add-on units come complete with 1 frames, 4 cross bars, top wire shelf, full extension slides, bottom dust cover and two 4" H casters, 1 with brake.

EXPAND YOUR STARTER UNIT
 with an add-on unit



PS-A2475-8WB
 Add-on with Wire Baskets



PS-A2475-8PT
 Add-on with Plastic Mesh Trays



PS-A2475-7S
 Add-on with Wire Shelves

PARtition Store Single Bay Carts

PERFORMANCE FEATURES

- Designed for transport of sterile supplies
- All-welded 1" square tubular epoxy-coated steel frame
- Sturdy base with solid shelf

QUANTUM
your medical storage solution!



PS-SBC58-6WB
29-1/2"D x 25"W x 58-1/2"H
1 - 3" wire baskets
4 - 5" wire baskets
1 - 8" wire baskets



PS-SBC58-6PT
29-1/2"D x 25"W x 58-1/2"H
5 - 5" trays
1 - 8" tray



PS-SBC58-6S
29-1/2"D x 25"W x 58-1/2"H
6 - wire shelves

FULL CAPACITY COMPARTMENTS
and minimizes dust



PS-SBC58-6WB
Wire Basket



PS-SBC58-6PT
Plastic Mesh Trays



PS-SBC58-6S
Wire Shelves

MAXIMUM CAPACITY
and versatility

COMPLETE PACKAGES
with drawers!



PS-DBC-14PT
Cart with Plastic Mesh Trays
29-1/2\"/>



PS-DBC-7WB7S
Cart with Wire Baskets & Shelves
29-1/2\"/>

Also available:
PS-DBC-14WB
Cart with Wire Baskets
29-1/2\"/>

PS-DBC-14S
Cart with Wire Shelves
29-1/2\"/>

PARTition Store Double Bay Carts

- Features designed for transport of sterile supplies
- All-welded 1-1/2" square tubular epoxy-coated steel frame
- Sturdy base with solid shelf insert for infection control
- 5" quiet poly swivel casters
- Standard donut bumpers on corners which protect walls and provide cushion impact
- Accessories include dividers and label holders
- Custom configurations are available, call a product specialist for details

QUANTUM
your medical storage solution!

Accessories

Wire Options

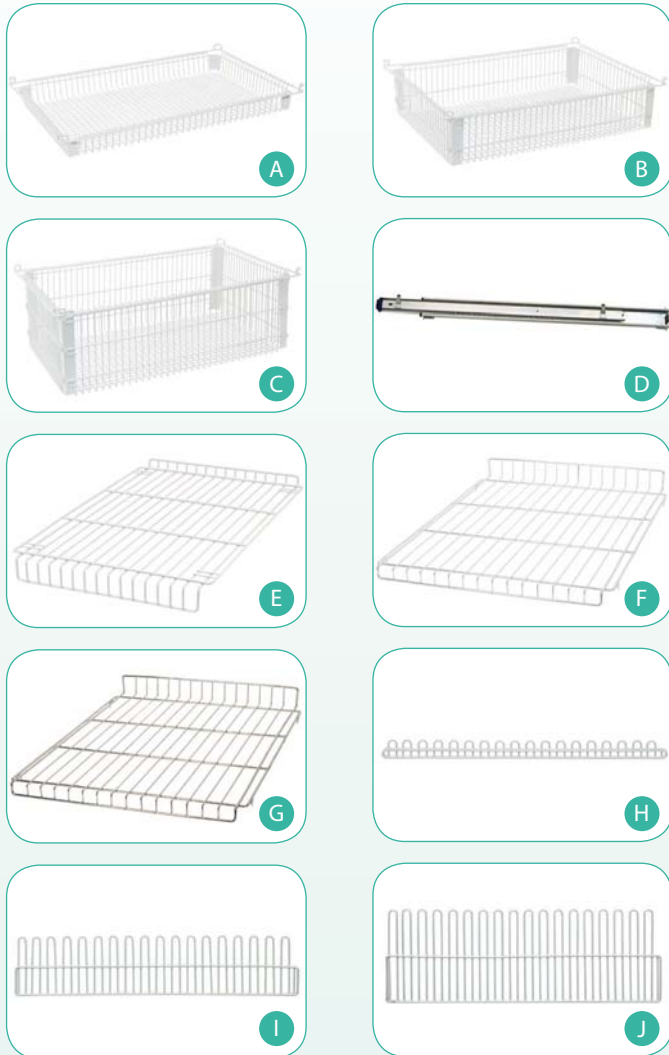

Wire Options

- A **PS-WB22143**
3" Wire Basket
22" x 14" x 3"
- B **PS-WB22145**
5" Wire Basket
22" x 14" x 5"
- C **PS-WB22148**
8" Wire Basket
22" x 14" x 8"
- D **PS-SE**
Slide Extension - Pair
PS-SSE
Slant Slide Extension - Pair
PS-WS2414
Flat Shelf Available in:
- White
- Chrome
- E **PS-TS22184WT**
White Top Shelf
PS-TS22184C
Chrome Top Shelf
- F **PS-WBLD-3**
3" Basket Long Divider
PS-WBSD-3
3" Basket Short Divider
- I **PS-WBLD-5**
5" Basket Long Divider
PS-WBSD-5
5" Basket Short Divider
- J **PS-WBLD-8**
8" Basket Long Divider
PS-WBSD-8
8" Basket Short Divider

**WIRE AND
PLASTIC OPTIONS
AVAILABLE!**

Plastic Options



Plastic Options

- A **PS-PT16242**
2" Solid Tray
24" x 16" x 2"
- B **PS-PMT16244**
4" Mesh Tray
24" x 16" x 4"
- C **PS-PT16244**
4" Solid Tray
24" x 16" x 4"
- D **PS-PMT16248**
8" Mesh Tray
24" x 16" x 8"
- E **PS-DC2214**
Bottom Dust Cover
22" x 14"
- F **PS-PLD2**
2" Tray Long Divider
PS-PSD2
2" Tray Short Divider
PS-PLD4
4" Tray Long Divider
- G **PS-PSD4**
4" Tray Short Divider
PS-PLD8
8" Tray Long Divider
PS-PSD8
8" Tray Short Divider
- H **PS-PTS**
Tray Stop
- I **PS-PDH**
Divider Holder
- J **PS-PLH**
Label Holder
- K **PS-PDL**
Divider Lock
PS-LH3
3" x 1-3/8"
Hanging Label Tag
Available in:
- Clear - Blue - Yellow
- Red - Green



Open Frame Cart

- Open Frame Carts complete with Trays
- Extended robust base, used for conveying of material between department
- Optional dividers allow trays to be divided every two inches, see *pg. 20*.

QUANTUM
your medical storage solution!

SINGLE & DOUBLE BAY CARTS
complete with trays



PS-PSBC-9
26-1/2"D x 27"W x 67"H
8 - 4" trays
1 - 8" tray



PS-PDBC-18
26-1/2"D x 44-1/2"W x 67"H
16 - 4" trays
2 - 8" trays

High Density Racks with Plastic Trays

- Achieves the highest level of storage capacity per square foot. Up to 60% additional storage capacity as compared to wire shelving
- Baskets can be divided every 2". Compartments can be made to fit the exact size and quantity of the supplies being stored
- Top basket is angled so those at the higher levels can still be fully accessed
- Top basket creates a gravity feed system
- Great for suture storage
- Tray stops **PS-PTS** are provided to prevent the accidental removal of baskets
- More cost effective than other similar systems available
- Two sizes are available to fit most space requirements

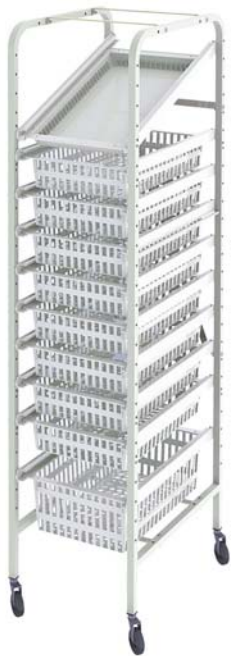

PS-P2674-1A9
Starter Unit
 26"D x 18"W x 74"H
 1 - 2" tray
 8 - 4" trays
 1 - 8" tray

Also available:
PS-PA2674-1A9
Add-on Unit
 26"D x 18"W x 74"H
 1 - 2" tray
 8 - 4" trays
 1 - 8" tray

Starter and Add-on Units

Starter units come complete with 2 frames, cross bars, full extension slides, trays and four 4"H casters.

Add-on units come complete with 1 frame, cross bars, full extension slides, trays and two 4"H casters.

QUANTUM
 your medical storage solution!



STARTER UNITS
 shown with 3 add-on units

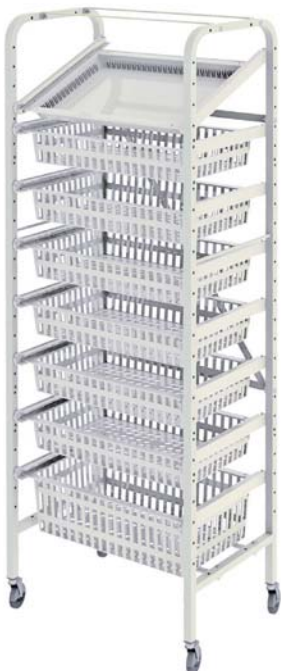

PS-P1874-1A7
Starter Unit
 18"D x 26"W x 74"H
 1 - 2" trays
 6 - 4" tray
 1 - 8" tray

Also available:
PS-PA1874-1A7
Add-on Unit
 18"D x 26"W x 74"H
 1 - 2" trays
 6 - 4" tray
 1 - 8" tray





COMPLETE PACKAGES
with trays!

PS-PD2674-2A8T6S
26"D x 36"W x 74"H
8 - 4" trays
2 - 8" trays
6 - instrument shelves



PS-PT2674-2A18T5S
26"D x 72"W x 74"H
14 - 4" trays
4 - 8" trays
5 - wire shelves
4 - shelf dividers

Accessories

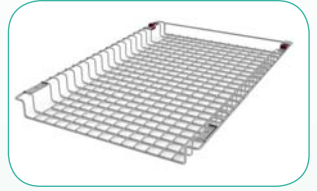

PS-PWIS1624
Instrument Shelf
24" x 16"



PS-PT16242
2" Solid Tray
24" x 16" x 2"



PS-PT16244
4" Solid Tray
24" x 16" x 4"



PS-PMT16244
4" Mesh Tray
24" x 16" x 4"



PS-PMT16248
8" Mesh Tray
24" x 16" x 8"



W-MC-AC45-333669
24-1/2"D x 29"W x 45"H
Drawer Configuration from top down:
3"-3"-3"-6"-6"-9"

6 Drawer Aluminum Crash Cart

QUANTUM
your medical storage solution!



W-MC-232436-5
24-1/2"D x 23"W x 36"H
Drawer configuration
from top down:
3"- 3"- 3"- 6"- 6"

Economy 5 Drawer Cart

PERFORMANCE FEATURES

- New dual pull-out shelves provide additional work surface on both sides of the cart
- Antimicrobial properties built-in to protect portions of the product
- 4 vertical aluminum corner mounting tracks to mount accessories without the need of pre-drilled holes
- 2 side mounting panels to assist in placement of accessories
- Dual push handles
- ABS cutaway plastic top minimizes wrist strain when writing or working on the cart's surface
- Centralized locking with 5 available options
- Ability to configure drawers to fit individual needs at no additional charge
- 5" premium easy roll casters, 1 full swivel, 2 swivel with brake and 1 swivel with tracking
- Stabilizer Base with high impact, non-marking plastic bumper to add stability and help keep cart from tipping
- Drawers with ball bearing slides were designed to push in and lock even after the cart has been secured
- Custom configurations are available, call a product specialist for details

PERFORMANCE FEATURES

- Antimicrobial properties built-in to protect portions of the product
- Centralized key locking standard
- Drawers with ball bearing slides designed to push in and lock even after the cart is secure
- Ergonomic push handles for ease while pushing
- Removable, easy to clean ABS plastic top
- 5" premium easy roll casters, 1 swivel, 2 with brake and 1 convertible tracking caster
- Stabilizer base with non-marking high impact plastic bumper
- Integrated drawer handles run the length of the drawer for easy access
- Cart is available in Light Gray

Accessories



W-MC-OTB
Oxygen Tank Bracket
16" adjustable velcro strap.



W-MC-CBB
Cardiac Board & Bracket



W-MC-SR1
Side Rail



W-MC-IV
IV Pole & Bracket



Aluminum Five-Drawer 24" Auto-Locking Mini Cart

PERFORMANCE FEATURES

- Lightweight aluminum construction
- Master code for all programming
- Access code for normal, daily use
- Up to 250 user codes possible
- Manual or automatic locking
- Auto-Lock timer can be set from 1 to 998 minutes, or it can be shut off so that the cart never auto-locks
- Auto-Lock timer programming can be limited to master code only
- Battery operated; never needs to be plugged into an outlet
- "Low Battery" indicator light
- Manual key override for emergency access



STORES UNDER Counters



A-MC-PR

Optional Proximity Reader
Simply wave the card in front of the reader to open. Lock the cart by pressing the "Lock" button or set the Auto-Lock Timer for anywhere from 1 to 998 minutes. The Proximity Reader will read most low frequency HID™ Prox Cards (125 kHz.)

A-MC-AA34-33369 + A-MC-PR

21-5/8"D x 21-1/2"W x 34-3/4"H
Drawer configuration from top down:
3" - 3" - 3" - 6" - 9"

11 DRAWER FRONT COLORS AVAILABLE!

- SG - Sage Green
- HG - Hunter Green
- MG - Moss Gray
- TL - Teal
- TC - Terra Cotta
- YL - Yellow
- BL - Blue
- TP - Taupe
- BG - Beige
- CW - Cherry Woodgrain
- LB - Light Blue

4 Drawer Steel Isolation Cart

PERFORMANCE FEATURES

- Antimicrobial properties built-in to protect portions of the product
- Ball bearing slides with quick release
- Dual push handles
- ABS plastic molded top
- 5" premium easy roll casters, 1 full swivel, 2 swivel with brake and 1 swivel with tracking
- Stabilizer Base with high impact, non-marking plastic bumper to add stability and help keep cart from tipping
- Pre-threaded holes on sides & back to easily mount accessories
- Latex Free
- Custom configurations are available, call a product specialist for details



QUANTUM your medical storage solution!

W-MC-SI43-4699
24-1/2"D x 29"W x 43-1/2"H
Drawer Configuration from top down:
4" - 6" - 9" - 9"

Accessories



W-MC-GBH
Glove Box Holder



W-MC-SH
Sharps Container Holder
(Sharps container not included)



W-MC-CR
Coat Rack



Steel Push-Button Cart

PERFORMANCE FEATURES

- Antimicrobial properties built-in to protect portions of the product
- Push-button locking with key override
- Ball bearing slides with quick release
- Dual push handles
- ABS plastic molded top
- 5" Premium easy roll casters, 1 full swivel, 2 swivel with brake and 1 swivel with tracking
- Stabilizer base with high impact, non-marking plastic bumper to add stability and help keep cart from tipping
- Pre-threaded holes on sides & back to easily mount accessories
- Latex free
- Custom configurations are available, call a product specialist for details



W-MC-SP43-43669
 24-1/2"D x 29"W x 43-1/2"H
 Drawer configuration from top down:
 4" - 3" - 6" - 6" - 9"

QUANTUM
 your medical storage solution!

5 & 6 Drawer Junior Tall Lightweight Aluminum Bedside/Slim Cart

PERFORMANCE FEATURES

- The patented U-Divide™ divider system included in every drawer
- New dual pull-out shelves provide additional work surface on both sides of the cart
- Antimicrobial properties built-in to protect portions of the product
- 4 vertical aluminum corner mounting tracks to mount accessories without the need of pre-drilled holes
- 2 side mounting panels to assist in placement of accessories.
- Dual push handles
- ABS plastic top minimizes wrist strain when writing or working on the cart's surface
- Centralized locking with 5 available options
- Ability to configure drawers to fit individual needs at no additional charge
- 5" premium easy roll casters, 1 full swivel, 2 swivel with brake and 1 swivel with tracking
- Stabilizer Base with high impact, non-marking plastic bumper to add stability and help keep cart from tipping
- Drawers with ball bearing slides were designed to push in and lock even after the cart has been secured
- Custom configurations are available, call a product specialist for details



W-MC-AB42-33669
 24-1/2"D x 23"W x 42"H
 Drawer configuration from top down:
 3" - 3" - 6" - 6" - 9"

16 DRAWER FRONT COLORS AVAILABLE!





**Aluminum Five-Drawer
24" Auto-Locking Cart**

**PERFORMANCE
FEATURES**

- Aluminum auto-locking cart
- Beige shell with eighteen drawer colors available
- 5" casters, 4 swivel, 2 with brake and 1 with tracking
- Custom configurations are available, call a product specialist for details



A-MC-AA39-33369

25-1/5"D x 34-1/2"W x 39-1/2"H
Includes bumper, handles and casters
Drawer configuration from top down:
3" - 3" - 3" - 6" - 9"

**THINK
LIGHT!**



Aluminum Cart

S-MC-A36-6666

20-1/2"D x 27-1/4"W x 36-3/4"H
Drawer configuration from top down:
6" - 6" - 6" - 6"

**PERFORMANCE
FEATURES**

- Durable lightweight aluminum construction with powder coat/ anodized aluminum finish
- Aluminum drawer box, with auto-return glides
- Adjustable drawer inserts for customized configurations
- Drawers can accommodate plastic trays with dividers
- Central key lock
- Seamless plastic top with raised edges and work surface that will pull-out on either side of the cart
- Accessory rails for mounting easy-access storage, convenience items, and many other accessories
- Integrated label holders on the drawers for quick identification of contents
- 4" medical grade plate locking casters
- Custom configurations are available, call a product specialist for details

**18 DRAWER FRONT COLORS
AVAILABLE!**

SG - Sage Green	BG - Beige	MV - Mauve	BL - Blue
MG - Moss Gray	AB - Crash Blue	YL - Yellow	RD - Red
TC - Terra Cotta	CR - Cranberry	TP - Taupe	SV - Silver
SB - Slate Blue	LB - Light Blue	TL - Teal	CW - Cherry Woodgrain
LV - Lavender	HG - Hunter Green		

4 TRIM COLORS AVAILABLE!

BL - Blue	RD - Red	YL - Yellow	WT - White
-----------	----------	-------------	------------

**LESS RUNNING,
more patient time!**

Accessories

A-MC-OTH
Oxygen Tank Bracket

A-MC-SUH
Suction Unit Holder

A-MC-IV
IV Pole

A-MC-CB
Cardiac Board

QUANTUM
your medical storage solution!

Accessories

CRASH ACCESSORY PACKAGE

S-MC-CAP

- IV Pole
- Oxygen Tank Holder
- Resuscitation Board
- Defibrillator Shelf
- Breakaway Lock bar

Medical Supply Carts



Quantum Medical supply carts are made of durable anodized aluminum weighing in at half the weight of traditional metal carts. Roll top tambour doors secure contents when closed and store out of the way when open. Carts are also available with glass doors. The interior provides a modular storage system that accepts a wide range of trays, baskets and department-specific accessories. An integrated rail system for accessories creates efficient storage on the exterior of the carts. These systems combine to make these carts infinitely customized to your specific medical storage needs. Custom configurations are available, call a product specialist for details.

DURABLE & LIGHTWEIGHT
Medical Supply Carts!

PERFORMANCE FEATURES

- 5" medical grade plate casters
- Central key lock
- Durable interior provides a modular system that accepts a wide range of trays, baskets and other storage accessories
- Built using a lightweight aluminum composite base and frame
- Side mounted accessory rail system with full line of height adjustable exterior accessories
- Easy-grip push/pull aluminum handle
- Custom configurations are available, call a product specialist for details



Roll Top Tambour Door
Also available for all carts

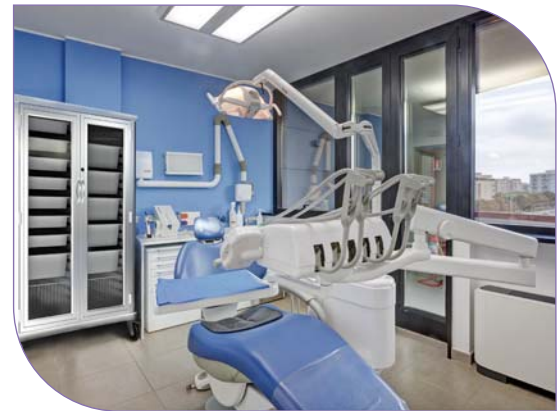

S-MC-SCH
Chart Holder
(Sold separately)



S-MC-A70GL-9 (Left Hinged Door)
S-MC-A70GR-9 (Right Hinged Door)

24"D x 29"W x 70"H

5 - 4" tray with 3 short and 3 long dividers
3 - 6" tray with 2 short and 2 long dividers

1 - 10" wire basket

Roll top model S-MC-A70-9
Shown with optional accessory
(Sold separately)



S-MC-A42G-9

29-1/2"D x 40-1/4"W x 42"H

3 - 4" tray with 3 short and 3 long dividers
4 - 6" tray with 2 short and 2 long dividers

2 - 10" wire basket

Roll top model S-MC-A42-9



Roll Top Tambour Door
Also available for all carts

S-MC-A60G-15
29-1/2"D x 40"W x 60"H
7 - 4" tray with 3 short and 3 long dividers
6 - 6" tray with 2 short and 2 long dividers
2 - 10" wire basket
Roll top model **S-MC-A60-15**



S-MC-SCH
Chart Holder
(Sold separately)

S-MC-SWB
Waste Basket
(Sold separately)

S-MC-A4080G-20
29-1/2"D x 40-1/4"W x 80"H
12 - 4" tray with 3 short and 3 long dividers
6 - 6" tray with 2 short and 2 long dividers
2 - 10" wire basket
2 - 24" metal shelf
4 - 24" adjustable metal shelf dividers
Roll top model **S-MC-A4080-20**
Shown with optional accessories
(Sold separately)



S-MC-S1GBH
Single Glove
Box Holder
(Sold separately)

S-MC-SESR
Embolectomy
Storage Rack
(Sold separately)

S-MC-A5780G-12
29-1/2"D x 57-1/4"W x 80"H
6 - 4" tray with 3 short and 3 long dividers
3 - 6" tray with 2 short and 2 long dividers
2 - 10" wire basket
8 - 24" metal shelf
16 - 24" adjustable metal shelf dividers
Roll top model **S-MC-A5780-12**
Shown with optional accessories
(Sold separately)



S-MC-SSC
Sharps
Container
(Sold separately)

S-MC-SFWS
Side Shelf
(Sold separately)

S-MC-A7480G-12
29-1/2"D x 74"W x 80"H
6 - 4" tray with 3 short and 3 long dividers
4 - 6" tray with 2 short and 2 long dividers
2 - 10" wire basket
13 - 24" metal shelf
26 - 24" adjustable metal shelf dividers
3 - 9" inline hook cath manager
Roll top model **S-MC-A7480-12**
Shown with optional accessories
(Sold separately)

Suture Carts



PERFORMANCE FEATURES

- 5" medical grade plate casters
- Central key lock
- Built using a lightweight aluminum composite base and frame
- Closed suture cart includes side mounted accessory rail system with full line of height adjustable exterior accessories
- Easy-grip push/pull aluminum handle
- Custom configurations are available, call a product specialist for details

DURABLE & LIGHTWEIGHT
Medical Supply Carts!



S-MC-A60-SC16
Double Sided Suture Cart
20-1/4"D x 32"W x 60"H
16 - adjustable shelves for suture box storage
(8 on each side)



S-MC-A60-CSC10
Closed Double Sided Suture Cart
24-1/4"D x 35-3/4"W x 60"H
10 - adjustable shelves for suture box storage
(5 on each side)
3 - 4" tray with 3 short and 3 long dividers
central key lock

Scope Storage Cabinets



PERFORMANCE FEATURES

- Foam scope cue with adjustable arms fits multiple sizes
- Cushioned upper and lower cord managers allow for easier management of both short and extra long endoscopes
- Cushioned removable drip pan slopes to center for easy cleaning
- Full cushioned back panel
- Optional HEPA fan unit available, model S-SC-HFVU



S-SC-183692E
18"D x 36"W x 92"H
8 - foam scope cue with adjustable arms



ROLL TOP
TAMBOUR DOOR
INCLUDED WITH ALL
SCOPE CABINETS

MODEL NO.	OUTSIDE DIMENSIONS W" x L" x H"	NO. OF SCOPES CABINET HOLDS	SHIP WGT
S-SC-182448B-5	18" x 24" x 48"	5	125 lbs
S-SC-182460B-5	18" x 24" x 60"	5	130 lbs
S-SC-182492E-5	18" x 24" x 92"	5	215 lbs
S-SC-182492E-10	18" x 24" x 92"	10	215 lbs
S-SC-183692E-8	18" x 36" x 92"	8	220 lbs
S-SC-183692E-16	18" x 36" x 92"	16	220 lbs
S-SC-184292E-9	18" x 42" x 92"	9	225 lbs
S-SC-184292E-18	18" x 42" x 92"	18	225 lbs
HEPA Filtered Fan Ventilation Unit			
S-SC-HFVU	-	-	4 lbs



S-SC-1836-1S5D7CM
18-3/4"D x 36"W x 84"H
1 - shelf with 5 adjustable dividers
7 - 7 hook catheter managers

S-SC-1842-1S7D9CM
18-3/4"D x 42"W x 84"H
1 - shelf with 7 adjustable dividers
9 - 7 hook catheter managers

S-SC-2436-1S5D7CM
24-3/4"D x 36"W x 84"H
1 - shelf with 5 adjustable dividers
7 - 9 hook catheter managers



S-SC-1836-1S5DBC
18-3/4"D x 36"W x 84"H
1 - shelf with 5 adjustable dividers
1 - box catheter cabinet

S-SC-1842-1S7DBC
18-3/4"D x 42"W x 84"H
1 - shelf with 7 - adjustable dividers
1 - box catheter cabinet

**AIRECORE CABINETS ARE
MOISTURE-RESISTANT
and easily cleaned!**



S-SC-1836-5S25D
18-3/4"D x 36"W x 84"H
5 - adjustable shelves
25 - adjustable shelf dividers

S-SC-1842-5S35D
18-3/4"D x 42"W x 84"H
5 - adjustable shelves
35 - adjustable shelf dividers

S-SC-2436-5S25D
24-3/4"D x 36"W x 84"H
5 - adjustable shelves
25 - adjustable shelf dividers



S-SC-1836-1S7CM
18-3/4"D x 36"W x 84"H
7 - 7 hook catheter managers

S-SC-1842-1S7CM
18-3/4"D x 42"W x 84"H
7 - 7 hook catheter managers

S-SC-2436-1S7CM
24-3/4"D x 36"W x 84"H
7 - 9 hook catheter managers



S-SC-1836-6S4CM
18-3/4"D x 36"W x 84"H
6 - adjustable shelves
4 - 7 hook catheter managers

S-SC-1842-6S4CM
18-3/4"D x 42"W x 84"H
6 - adjustable shelves
4 - 7 hook catheter managers



S-SC-2436-2S4D22
24-3/4"D x 36"W x 84"H
2 - adjustable shelves
4 - adjustable shelf dividers
14 - 4" tray with 3 short and 3 long dividers
6 - 6" tray with 2 short and 2 long dividers
2 - 10" wire basket



**ROLL TOP
TAMBOUR DOOR
INCLUDED WITH
ALL CABINETS**

Wire Utility Carts

Give versatility to any operation: food service, hospitals and maintenance. Carts consists of 2 u-handles, 4 donut bumpers, 4 swivel casters, 2 with brake and wire or solid shelf combinations.



WRC-1836-3



WRC-1836-2CG



WRC-1836-3G



WRC-IT1824
(Cylinders not included)

HEIGHT FROM FLOOR TO TOP SHELF

29-1/2" H



WRC-1836-2

37-1/2" H

HEIGHT FROM FLOOR TO TOP OF HANDLE

Cylinder Transport / Inhalation Therapy Cart

Mobile unit can transport up to 12 of the D and/or E cylinders. Protective vinyl coated wires separate and protect cylinders. Unit consists of two u-handles, 4 donut bumpers, 4 conductive swivel casters (2 with brakes), 1 wire shelf and 2 frames with coated wire grid shelf. **Wire Finish:** Chrome

MODEL NO.	SHIP WGT
Mobile Cylinder Cart 18" x 24" x 37-1/2"	
WRC-IT1824	45 lbs

DIMENSIONS W" x L" x H"	WIRE SHELF		WIRE & SOLID SHELF		SOLID SHELF	
	MODEL NO.	SHIP WGT	MODEL NO.	SHIP WGT	MODEL NO.	SHIP WGT
	2 Wire Shelf Mobile Utility Cart		1 Wire & 1 Solid Shelf Mobile Utility Cart		2 Solid Shelf Mobile Utility Cart	
18" x 36" x 37-1/2"	WRC-1836-2	30 lbs	WRC-1836-2CG	37 lbs	WRC-1836-2G	44 lbs
18" x 42" x 37-1/2"	WRC-1842-2	32 lbs	WRC-1842-2CG	41 lbs	WRC-1842-2G	50 lbs
18" x 48" x 37-1/2"	WRC-1848-2	37 lbs	WRC-1848-2CG	45 lbs	WRC-1848-2G	56 lbs
24" x 36" x 37-1/2"	WRC-2436-2	36 lbs	WRC-2436-2CG	42 lbs	WRC-2436-2G	48 lbs
24" x 42" x 37-1/2"	WRC-2442-2	40 lbs	WRC-2442-2CG	47 lbs	WRC-2442-2G	54 lbs
24" x 48" x 37-1/2"	WRC-2448-2	44 lbs	WRC-2448-2CG	52 lbs	WRC-2448-2G	60 lbs
	3 Wire Shelf Mobile Utility Cart		2 Wire & 1 Solid Shelf Mobile Utility Cart		3 Solid Shelf Mobile Utility Cart	
18" x 36" x 37-1/2"	WRC-1836-3	37 lbs	WRC-1836-3CG	46 lbs	WRC-1836-3G	60 lbs
18" x 42" x 37-1/2"	WRC-1842-3	42 lbs	WRC-1842-3CG	49 lbs	WRC-1842-3G	68 lbs
18" x 48" x 37-1/2"	WRC-1848-3	48 lbs	WRC-1848-3CG	52 lbs	WRC-1848-3G	76 lbs
24" x 36" x 37-1/2"	WRC-2436-3	49 lbs	WRC-2436-3CG	55 lbs	WRC-2436-3G	67 lbs
24" x 42" x 37-1/2"	WRC-2442-3	55 lbs	WRC-2442-3CG	62 lbs	WRC-2442-3G	76 lbs
24" x 48" x 37-1/2"	WRC-2448-3	60 lbs	WRC-2448-3CG	68 lbs	WRC-2448-3G	84 lbs

Polymer Utility Carts

Rugged, heavy-duty carts are ideal for any application. Carts will not rust, dent, chip or peel and are impervious to most chemicals, making them easy to clean. Set of 2 swivel and 2 rigid 5" x 1-1/4" heavy-duty casters allow for 550 lb. load capacity and provide a soft ride, even on rough surfaces. Comfort grip push handle allows for easy handling. Available in two sizes with a 2 or 3 shelf combination. Also available, Flat Top Shelf cart with a 2 or 3 shelf combination. All carts available in Gray.



PC4026-33
40"L x 26"W x 32-1/2"H
(Also available in a 3 shelf design)



PFTC4026-33-3
40"L x 26"W x 32-1/2"H
(Also available in a 2 shelf design)

**CARTS OFFER
550 lb.
load capacity!**



PC3518-33
34-1/4"L x 17-1/2"W x 32-1/2"H
(Also available in a 3 shelf design)



PC3518-33-3
34-1/4"L x 17-1/2"W x 32-1/2"H
(Also available in a 2 shelf design)

MODEL NO.	OUTSIDE DIMENSIONS L" x W" x H"	INSIDE SHELF DIMENSIONS L" x W"	NO. OF SHELVES	SHIP WGT
PC3518-33	34-1/4" x 17-1/2" x 32-1/2"	29-1/4" x 15-1/4"	2	38 lbs
PC3518-33-3	34-1/4" x 17-1/2" x 32-1/2"	29-1/4" x 15-1/4"	3	51 lbs
PC4026-33	40" x 26" x 32-1/2"	35" x 23"	2	54 lbs
PC4026-33-3	40" x 26" x 32-1/2"	35" x 23"	3	74 lbs
Plastic Flat Top Shelf Cart				
PFTC4026-33-2	40" x 26" x 32-1/2"	35" x 23"	2	51 lbs
PFTC4026-33-3	40" x 26" x 32-1/2"	35" x 23"	3	71 lbs
Additional Shelves				
PC3518SHELF	34-1/4" x 17-1/2"	29-1/4" x 15-1/4"	1	13 lbs
PC4026SHELF	40" x 26"	35" x 23"	1	20 lbs



ABS HEAVY-DUTY LID

DOUBLE RING BAG HOLDER

18-M-HAMP
20"W x 18"L x 38"H

FOUR 3" CASTERS
(2 with brake)

FOOT LEVER

Hamper

Single bag hamper offers foot activated ABS heavy-duty lid for quick accessibility. Double ring bag holder allows for quick bag insertion and bag lock. Supports 36-42 gallon multi-purpose bags with a ring to keep bag in place. Four 3" casters (2 with brake) allows for easy mobility. **Finish:** Chrome

MODEL NO.	DIMENSIONS W" x L" x H"	SHIP WGT
18-M-HAMP	20" x 18" x 38"	21 lbs



TWO DESIGNS AVAILABLE!



WRC-SW2448
24"W x 48"L x 69"H

WRC-LPSW1863
18"W x 63"L x 39-1/2"H

Sterile Wrap Carts

Hang bars keep sterile wraps separated and accessible for special preps. Bars are easy to adjust. Neoprene gaskets hold wraps in position. Two designs to choose from (cascading or flat surface). **Finish:** Chrome

MODEL NO.	DIMENSIONS W" x L" x H"	SHIP WGT
Sterile Wrap Cart		
WRC-SW2448	24" x 48" x 69"	103 lbs
Low Profile, Sterile Wrap Cart		
WRC-LPSW1863	18" x 63" x 39-1/2"	46 lbs



WRSC3-42-2436FS
24"W x 36"L x 48"H



WRSC4-54-2436FS
24"W x 36"L x 60"H



Adjustable
from 3" - 27"
under top shelf

SST-2436U
24"W x 36"L x 34"H

Open Surgical Case Carts

Corrosion-free surgical case cart transports and delivers surgical instrumentation packs from the OR supply center to the operating room. **Finish:** 304 Stainless Steel

3 Sided Frame

Finish: 304 Stainless Steel

STAINLESS MODEL NO.	DIMENSIONS W" x L"	SHIP WGT
2436FS	24" x 36"	8 lbs
2448FS	24" x 48"	9 lbs
2460FS	24" x 60"	10 lbs

Each unit consists of:

- 4 - 42" stainless steel posts
- 2 - stainless steel wire shelves
- 1 - stainless steel solid shelf
- 1 - stainless steel 3-sided frame
- 1 - stainless steel push handle
- 4 - 5" swivel, stainless steel poly stem casters and 2 with brake (casters come with Zerk grease fittings)
- 4 - donut bumpers

MODEL NO.	DIMENSIONS W" x L" x H"	NO. OF SHELVES	SHIP WGT
WRSC3-42-2436FS	24" x 36" x 48"	3	77 lbs
WRSC3-42-2448FS	24" x 48" x 48"	3	88 lbs
WRSC3-42-2460FS	24" x 60" x 48"	3	106 lbs

Each unit consists of:

- 4 - 54" stainless steel posts
- 3 - stainless steel wire shelves
- 1 - stainless steel solid shelf
- 1 - stainless steel 3-sided frame
- 1 - stainless steel push handle
- 4 - 5" swivel, stainless steel poly stem casters and 2 with brake (casters come with Zerk grease fittings)
- 4 - donut bumpers

MODEL NO.	DIMENSIONS W" x L" x H"	NO. OF SHELVES	SHIP WGT
WRSC4-54-2436S	24" x 36" x 60"	4	94 lbs
WRSC4-54-2448S	24" x 48" x 60"	4	108 lbs
WRSC4-54-2460S	24" x 60" x 60"	4	131 lbs

Stainless Steel Work Table with Adjustable Underself



Heavy-duty 304 stainless steel processing tables are ideal for pack and prep in sterile environments. Units consist of a flat top work surface with hemmed edges and the lower flat bottom shelf is adjustable from 3" to 27" high. Tables are NSF approved. The support legs are 1-5/8" diameter with a leveling foot which can be converted to a mobile unit with a 3" conductive caster kit, all swivel and 2 with brake. (Sold separately) **Finish:** 304 Stainless Steel

MODEL NO.	DIMENSIONS W" x L" x H"	NO. OF SHELVES	SHIP WGT
Stationary Instrument Table with Shelf			
SST-2436U	24" x 36" x 34"	1	50 lbs
SST-2448U	24" x 48" x 34"	1	60 lbs
SST-2460U	24" x 60" x 34"	1	70 lbs
SST-2472U	24" x 72" x 34"	1	80 lbs
Mobile Kit			
SST-MOB	4 Swivel Casters, 2 with Brakes		4 lbs

Bin Transport Carts

Modular in design, the Bin Transport Cart provides an integrated system to transfer items. Carts enable you to color code, hold or transport inventories and supplies. Ideal for use in central supply and laundry. Bins are autoclavable up to 250°F. Bins available in Blue, Red and Yellow. **Cart Finish:** Chrome

Available in: ● Blue ● Red ● Yellow

MODEL NO.	NO. OF SHELVES	NO. OF BINS	BIN DIMENSIONS L" x W" x H"	SHIP WGT
30"x 36" x 69" Wire Shelving Unit with HULK Containers				
WRC2-63-3036-974976	2	2	29-7/8" x 16-1/2" x 11"	150 lbs
		6	29-7/8" x 16-1/2" x 15"	
30"x 36" x 42" Wire Shelving Unit with HULK Containers				
WRC2-36-3036-976	2	4	29-7/8" x 16-1/2" x 15"	88 lbs



WRC2-63-3036-974976

WRC2-36-3036-976

COMPLETE PACKAGES with bins!

Bins & Wire Shelves Transport Cart

The combination of bins and modular shelving creates a highly efficient method of visually identifying and transporting multiple items. The large capacity bins allow for color coding and the rotation of inventories. This multi-tasked unit is excellent for a wide variety of applications and transport solutions. Bins are available in Blue, Red, Yellow and Clear. **Cart Finish:** Chrome

Each unit consists of:

- 4 - 63" posts
- 2 - 54" posts
- 2 - 24" x 60" wire shelves
- 3 - 24" x 36" wire shelves
- 4 - 5" swivel poly stem casters, 2 with brakes
- 4 - donut bumpers
- 4 - QUS955 (23-7/8" x 18-1/4" x 12")



Available in: ● Blue ● Red ● Yellow ● Clear

MODEL NO.	DIMENSIONS W" x L" x H"	NO. OF BINS	SHIP WGT
WRCPL-63-2460-955	24" x 60" x 69"	4 QUS955	165 lbs



WRCPL-63-2460-955

COMPLETE PACKAGES with bins!

Hanging Label Tags

3"W x 1-3/8"H Hanging label tag available in 5 colors. Package of 25.

5 COLORS AVAILABLE!



Clear Red Yellow Blue Green



PS-LH3
3" x 1-3/8"

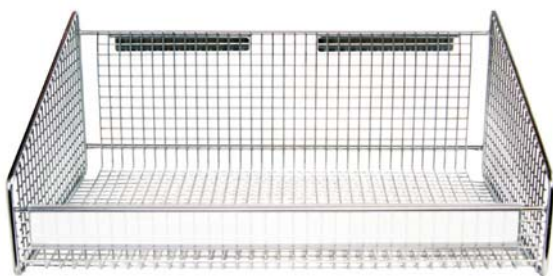

HBL165C



1436BC
Shown with Dividers and Clear Label Holder
(Sold separately)

Hanging Basket Clear Label Holders

A user friendly method for identifying product. Affixes directly to the front on any hanging basket. Available in three lengths. (Sold separately)

MODEL NO.	DESCRIPTION	SHIP WGT
Clear Label Holders		
HBL3C	3" Clear Label Holder	1 lb
HBL165C	16-1/2" Clear Label Holder	1 lb
HBL345C	34-1/2" Clear Label Holder	1 lb

Stacking Basket Clear Label Holders

A user friendly method for identifying product. Affixes directly to the front on any stacking basket. Available in three lengths. (Sold separately)

MODEL NO.	DESCRIPTION	SHIP WGT
Clear Label Holders		
BLH3C	3" Clear Label Holder	1 lb
BLH14C	14" Clear Label Holder	1 lb
BLH32C	32" Clear Label Holder	1 lb

QUANTUM your medical storage solution!



LH3C and LH3B Front Shelf View



LHA3C Top Shelf View



LHA3C Bottom Shelf View

Shelf Label Holders

Are an excellent method for identifying product. Affix directly to truss on any size shelf. Ten lengths to choose from.

MODEL NO.	DESCRIPTION	SHIP WGT
Full Length Label Holders		
LH3B	3" Gray Label Holder	1 lb
LH3C	3" Clear Label Holder	1 lb
LH12C	12" Clear Label Holder	1 lb
LH24C	24" Clear Label Holder	1 lb
Angled Label Holder - 30°, 60° and 90°		
LHA3C	3" Angled Clear Label Holder	1 lb

Shelves - Finish Options



Chrome - A bright, shiny surface which comes from a plating process where hard chrome is deposited over a nickel surface. This finish is the most popular utilized due to it being extremely durable and able to be used in almost any type of application.

304 Stainless Steel - 304 Stainless with an electropolish finish represents the highest industry standard in the prevention of corrosion. This finish is highly effective in clean rooms, sanitary environments, or anywhere corrosion is possible.

Proform - Is an economical solution for high humidity or wet environment. The carbon steel is treated with a zinc phosphate base. A hybrid epoxy with an antibacterial agent is electrostatically applied over the treated surface offering antimicrobial protection. **Color:** Light Green

PERFORMANCE FEATURES

- All welded construction with additional wire trussing for high strength characteristics
- Top mat wires run front to back (except on 12" x 36" size) for ease of loading and unloading
- Wire allows air to circulate and light to penetrate for increased product visibility
- Minimal dirt accumulation
- Split conical sleeve adaptors secure shelf corner to post
- Numbered grooved posts on 1" increments for quick assembly
- No tools required for assembly
- Adjustable foot levelers
- Durable finishes
- Aesthetically pleasing
- Optional accessories
- National Sanitation Foundation (NSF) Approved
- Shipped KD Class 70
- 600 to 800 lb. capacity per shelf



CHROME

304 STAINLESS STEEL

PROFORM

GALVANIZED STEEL SOLID

STAINLESS STEEL SOLID

Wire Shelves

Genuine Quantum modular wire systems offer a unique combination of shelf and post sizes in a variety of finishes to compliment any application. The all welded shelf construction is supported with architectural wire trusses to provide between 600 lb. and 800 lb. capacity per shelf.

SHELF W" x L"	SHIP WGT	CHROME	STAINLESS STEEL	PROFORM
		MODEL NO.	MODEL NO.	MODEL NO.
12" Deep Wire Shelves				
12" x 24"	6 lbs	1224C	1224S*	1224P*
12" x 30"	6 lbs	1230C	1230S*	1230P*
12" x 36"	7 lbs	1236C	1236S	1236P
12" x 42"	8 lbs	1242C	1242S*	1242P*
12" x 48"	9 lbs	1248C	1248S	1248P
12" x 60"	14 lbs	1260C	1260S	1260P
12" x 72"	17 lbs	1272C	1272S	1272P
14" Deep Wire Shelves				
14" x 24"	6 lbs	1424C	1424S*	1424P*
14" x 30"	7 lbs	1430C	1430S	1430P*
14" x 36"	8 lbs	1436C	1436S	1436P
14" x 42"	10 lbs	1442C	1442S	1442P*
14" x 48"	11 lbs	1448C	1448S	1448P
14" x 54"	12 lbs	1454C	1454S	1454P*
14" x 60"	14 lbs	1460C	1460S	1460P
14" x 72"	17 lbs	1472C	1472S	1472P
18" Deep Wire Shelves				
18" x 24"	7 lbs	1824C	1824S	1824P*
18" x 30"	8 lbs	1830C	1830S	1830P
18" x 36"	10 lbs	1836C	1836S	1836P
18" x 42"	11 lbs	1842C	1842S	1842P
18" x 48"	14 lbs	1848C	1848S	1848P
18" x 54"	15 lbs	1854C	1854S	1854P
18" x 60"	17 lbs	1860C	1860S	1860P
18" x 72"	20 lbs	1872C	1872S	1872P
21" Deep Wire Shelves				
21" x 24"	8 lbs	2124C	2124S	2124P*
21" x 30"	9 lbs	2130C	2130S	2130P*
21" x 36"	11 lbs	2136C	2136S	2136P
21" x 42"	12 lbs	2142C	2142S	2142P*
21" x 48"	14 lbs	2148C	2148S	2148P
21" x 54"	16 lbs	2154C	2154S	2154P*
21" x 60"	18 lbs	2160C	2160S	2160P
21" x 72"	24 lbs	2172C	2172S	2172P
24" Deep Wire Shelves				
24" x 24"	9 lbs	2424C	2424S	2424P*
24" x 30"	11 lbs	2430C	2430S	2430P
24" x 36"	13 lbs	2436C	2436S	2436P
24" x 42"	15 lbs	2442C	2442S	2442P
24" x 48"	16 lbs	2448C	2448S	2448P
24" x 54"	18 lbs	2454C	2454S	2454P
24" x 60"	21 lbs	2460C	2460S	2460P
24" x 66"	23 lbs	2466C	2466S*	2466P
24" x 72"	26 lbs	2472C	2472S	2472P
30" Deep Wire Shelves				
30" x 36"	15 lbs	3036C	3036S	3036P
30" x 42"	18 lbs	3042C	3042S	3042P
30" x 48"	21 lbs	3048C	3048S	3048P
30" x 60"	27 lbs	3060C	3060S	3060P
30" x 72"	31 lbs	3072C	3072S	3072P
36" Deep Wire Shelves				
36" x 36"	18 lbs	3636C	3636S	3636P
36" x 48"	23 lbs	3648C	3648S	3648P
36" x 60"	29 lbs	3660C	3660S	3660P
36" x 72"	35 lbs	3672C	3672S	3672P

* Special order. Minimum quantity and extended lead time may apply. Please call for details.

Shelving Posts

All posts are fabricated from 16 gauge carbon steel with location grooves on 1" increments and ease for shelf installation. Numbers are printed between grooves for quick assembly. Posts are double grooved in consistent intervals for quick identification. Leveling legs are enclosed with all posts. Leveling legs cannot be used in conjunction with stem casters. See pg. 79 to order caster sets. Custom post heights are available, call for pricing.

DESCRIPTION	SHIP WGT	CHROME	STAINLESS STEEL	PROFORM
		MODEL NO.	MODEL NO.	MODEL NO.
6"H Post	1 lb	P6C	P6S	P6P
14"H Post	1 lb	P14C	P14S	P14P
34"H Post	2 lbs	P34C	P34S	P34P
36"H Post	2 lbs	P36C	P36S*	P36P*
39"H Post	2 lbs	P39C	P39S*	P39P*
42"H Post	2 lbs	P42C*	P42S	P42P*
54"H Post	3 lbs	P54C	P54S	P54P
63"H Post	4 lbs	P63C	P63S	P63P
74"H Post	4 lbs	P74C	P74S	P74P
86"H Post	5 lbs	P86C	P86S	P86P
96"H Post	6 lbs	P96C	P96S	P96P

* Not a standard inventory size. To purchase, order next size up and apply cut charge to cut to this custom height.



W-PC-STUD
Fully threaded **Stud Connector** can be utilized to connect two posts enabling any post height to be achieved

LASER PRINTED NUMBERS
For quick shelf positioning

W-PLI
Post Insert

W-PLB
Post Leveler adjusts up or down allowing height flexibility

Solid Shelves

- Designed for storage of small parts that might normally fall through wire shelves
- Dual layer construction with double hemmed perimeter with marine edge ensures maximum strength while retaining spillage
- Excellent corrosion resistance

DIMENSIONS W" x L"	SHIP WGT	GALVANIZED STEEL	STAINLESS STEEL
		MODEL NO.	MODEL NO.
14" Deep Solid Shelves			
14" x 36"	14 lbs	1436SG	1436SS
14" x 42"	15 lbs	1442SG	1442SS
14" x 48"	17 lbs	1448SG	1448SS
14" x 54"	20 lbs	1454SG	1454SS
14" x 60"	22 lbs	1460SG	1460SS
14" x 72"	26 lbs	1472SG	1472SS
18" Deep Solid Shelves			
18" x 24"	11 lbs	1824SG	1824SS
18" x 30"	14 lbs	1830SG	1830SS
18" x 36"	16 lbs	1836SG	1836SS
18" x 42"	18 lbs	1842SG	1842SS
18" x 48"	20 lbs	1848SG	1848SS
18" x 54"	22 lbs	1854SG	1854SS
18" x 60"	24 lbs	1860SG	1860SS
18" x 72"	27 lbs	1872SG	1872SS
21" Deep Solid Shelves			
21" x 24"	13 lbs	2124SG	2124SS
21" x 30"	15 lbs	2130SG	2130SS
21" x 36"	18 lbs	2136SG	2136SS
21" x 42"	21 lbs	2142SG	2142SS
21" x 48"	23 lbs	2148SG	2148SS
21" x 54"	25 lbs	2154SG	2154SS
21" x 60"	28 lbs	2160SG	2160SS
21" x 72"	30 lbs	2172SG	2172SS
24" Deep Solid Shelves			
24" x 24"	15 lbs	2424SG	2424SS
24" x 30"	17 lbs	2430SG	2430SS
24" x 36"	19 lbs	2436SG	2436SS
24" x 42"	22 lbs	2442SG	2442SS
24" x 48"	24 lbs	2448SG	2448SS
24" x 54"	26 lbs	2454SG	2454SS
24" x 60"	31 lbs	2460SG	2460SS
24" x 72"	34 lbs	2472SG	2472SS

18 Gauge Galvanized or 304 Stainless Steel

ASSEMBLING WIRE SHELVING UNITS

is as easy as
1 - 2 - 3...



1. Snap plastic sleeve around post.



2. Slide shelf over sleeve for secure locking.

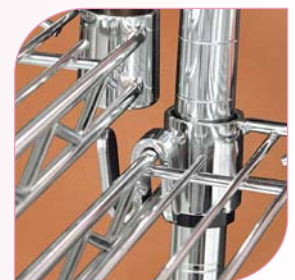

3. Two "S-Hooks" are used to connect add-on wire shelf to starter units.



Starter Kits

Heavy-duty shelving unit allows up to 800 lb. shelf capacity. Starter kits come complete with 4 posts and 4 or 5 shelves. Additional shelves may be purchased separately. See chart on pg. 38. Mobilize starter kit shelving unit using optional mobile kit **WR-00H**. See pg. 79. **Finishes:** Chrome, Stainless Steel and Proform



STARTER KITS



MOBILIZE YOUR WIRE SHELVING

DB - Donut Bumper

Non-marking donut bumper used to protect walls and help cushion impact.

WR-00H (Mobile Kit)*

Set of four swivel polyurethane 5" x 1-1/4" casters, two with brakes. Can be used with all units shown. 1,200 lb. load capacity. *Mobile kits recommended only for shelves 18" and wider.



S-HOOKS

For continuous runs of shelving. Two hooks should be placed per shelf where two posts are not utilized.



ADD-ON KIT

TO CHOOSE FINISH ADD FINISH SUFFIX TO MODEL NO.
Example: Chrome WR54-1236C
Stainless WR54-1236S
Proform WR54-1236P

TO CHOOSE FINISH ADD FINISH SUFFIX TO MODEL NO.
Example: Chrome WR54-1236C-5
Stainless WR54-1236S-5
Proform WR54-1236P-5

Chrome
Stainless
Proform

SHELF W" x L"	54"H WIRE SHELVING 4 SHELVES				54"H WIRE SHELVING 5 SHELVES				AVAILABLE FINISHES		
	STARTER KIT	ADD-ON KIT	STARTER KIT	ADD-ON KIT	STARTER KIT	ADD-ON KIT	STARTER KIT	ADD-ON KIT	C	S	P
12" x 36"	WR54-1236	40 lbs	AD54-1236	36 lbs	WR54-1236-5	47 lbs	AD54-1236-5	45 lbs	Y	Y	Y
12" x 42"	WR54-1242	44 lbs	AD54-1242	40 lbs	WR54-1242-5	52 lbs	AD54-1242-5	50 lbs	Y	N	N
12" x 48"	WR54-1248	48 lbs	AD54-1248	44 lbs	WR54-1248-5	57 lbs	AD54-1248-5	55 lbs	Y	Y	Y
12" x 60"	WR54-1260	56 lbs	AD54-1260	52 lbs	WR54-1260-5	70 lbs	AD54-1260-5	68 lbs	Y	Y	Y
12" x 72"	WR54-1272	64 lbs	AD54-1272	60 lbs	WR54-1272-5	81 lbs	AD54-1272-5	79 lbs	Y	Y	Y
14" x 24"	WR54-1424	36 lbs	AD54-1424	32 lbs	WR54-1424-5	42 lbs	AD54-1424-5	40 lbs	Y	N	N
14" x 30"	WR54-1430	40 lbs	AD54-1430	36 lbs	WR54-1430-5	47 lbs	AD54-1430-5	45 lbs	Y	Y	N
14" x 36"	WR54-1436	44 lbs	AD54-1436	40 lbs	WR54-1436-5	52 lbs	AD54-1436-5	50 lbs	Y	Y	Y
14" x 42"	WR54-1442	52 lbs	AD54-1442	48 lbs	WR54-1442-5	62 lbs	AD54-1442-5	60 lbs	Y	Y	N
14" x 48"	WR54-1448	56 lbs	AD54-1448	52 lbs	WR54-1448-5	67 lbs	AD54-1448-5	65 lbs	Y	Y	Y
14" x 54"	WR54-1454	60 lbs	AD54-1454	56 lbs	WR54-1454-5	72 lbs	AD54-1454-5	70 lbs	Y	Y	N
14" x 36"	WR54-1460	68 lbs	AD54-1460	64 lbs	WR54-1460-5	82 lbs	AD54-1460-5	80 lbs	Y	Y	Y
14" x 72"	WR54-1472	80 lbs	AD54-1472	76 lbs	WR54-1472-5	97 lbs	AD54-1472-5	95 lbs	Y	Y	Y
18" x 24"	WR54-1824	40 lbs	AD54-1824	36 lbs	WR54-1824-5	47 lbs	AD54-1824-5	45 lbs	Y	Y	N
18" x 30"	WR54-1830	44 lbs	AD54-1830	40 lbs	WR54-1830-5	52 lbs	AD54-1830-5	50 lbs	Y	Y	Y
18" x 36"	WR54-1836	52 lbs	AD54-1836	48 lbs	WR54-1836-5	62 lbs	AD54-1836-5	60 lbs	Y	Y	Y
18" x 42"	WR54-1842	56 lbs	AD54-1842	52 lbs	WR54-1842-5	67 lbs	AD54-1842-5	65 lbs	Y	Y	Y
18" x 48"	WR54-1848	60 lbs	AD54-1848	56 lbs	WR54-1848-5	74 lbs	AD54-1848-5	72 lbs	Y	Y	Y
18" x 54"	WR54-1854	72 lbs	AD54-1854	68 lbs	WR54-1854-5	87 lbs	AD54-1854-5	81 lbs	Y	Y	Y
18" x 60"	WR54-1860	80 lbs	AD54-1860	76 lbs	WR54-1860-5	97 lbs	AD54-1860-5	95 lbs	Y	Y	Y
18" x 72"	WR54-1872	92 lbs	AD54-1872	88 lbs	WR54-1872-5	112 lbs	AD54-1872-5	58 lbs	Y	Y	Y
21" x 24"	WR54-2124	44 lbs	AD54-2124	40 lbs	WR54-2124-5	52 lbs	AD54-2124-5	50 lbs	Y	Y	N
21" x 30"	WR54-2130	48 lbs	AD54-2130	44 lbs	WR54-2130-5	57 lbs	AD54-2130-5	59 lbs	Y	Y	N
21" x 36"	WR54-2136	56 lbs	AD54-2136	52 lbs	WR54-2136-5	67 lbs	AD54-2136-5	65 lbs	Y	Y	Y
21" x 42"	WR54-2142	60 lbs	AD54-2142	56 lbs	WR54-2142-5	72 lbs	AD54-2142-5	70 lbs	Y	Y	N
21" x 48"	WR54-2148	68 lbs	AD54-2148	64 lbs	WR54-2148-5	82 lbs	AD54-2148-5	84 lbs	Y	Y	Y
21" x 54"	WR54-2154	76 lbs	AD54-2154	72 lbs	WR54-2154-5	92 lbs	AD54-2154-5	94 lbs	Y	Y	N
21" x 60"	WR54-2160	84 lbs	AD54-2160	80 lbs	WR54-2160-5	102 lbs	AD54-2160-5	108 lbs	Y	Y	Y
21" x 72"	WR54-2172	108 lbs	AD54-2172	104 lbs	WR54-2172-5	132 lbs	AD54-2172-5	130 lbs	Y	Y	Y
24" x 24"	WR54-2424	48 lbs	AD54-2424	44 lbs	WR54-2424-5	57 lbs	AD54-2424-5	55 lbs	Y	Y	N
24" x 30"	WR54-2430	56 lbs	AD54-2430	52 lbs	WR54-2430-5	67 lbs	AD54-2430-5	65 lbs	Y	Y	Y
24" x 36"	WR54-2436	64 lbs	AD54-2436	60 lbs	WR54-2436-5	77 lbs	AD54-2436-5	75 lbs	Y	Y	Y
24" x 42"	WR54-2442	72 lbs	AD54-2442	68 lbs	WR54-2442-5	87 lbs	AD54-2442-5	85 lbs	Y	Y	Y
24" x 48"	WR54-2448	76 lbs	AD54-2448	72 lbs	WR54-2448-5	92 lbs	AD54-2448-5	90 lbs	Y	Y	Y
24" x 54"	WR54-2454	84 lbs	AD54-2454	80 lbs	WR54-2454-5	102 lbs	AD54-2454-5	100 lbs	Y	Y	Y
24" x 60"	WR54-2460	96 lbs	AD54-2460	92 lbs	WR54-2460-5	117 lbs	AD54-2460-5	115 lbs	Y	Y	Y
24" x 72"	WR54-2472	116 lbs	AD54-2472	112 lbs	WR54-2472-5	142 lbs	AD54-2472-5	142 lbs	Y	Y	Y
30" x 36"	WR54-3036	72 lbs	AD54-3036	68 lbs	WR54-3036-5	87 lbs	AD54-3036-5	85 lbs	Y	Y	Y
30" x 42"	WR54-3042	84 lbs	AD54-3042	80 lbs	WR54-3042-5	102 lbs	AD54-3042-5	100 lbs	Y	Y	Y
30" x 48"	WR54-3048	96 lbs	AD54-3048	92 lbs	WR54-3048-5	117 lbs	AD54-3048-5	115 lbs	Y	Y	Y
30" x 60"	WR54-3060	120 lbs	AD54-3060	116 lbs	WR54-3060-5	147 lbs	AD54-3060-5	145 lbs	Y	Y	Y
30" x 72"	WR54-3072	136 lbs	AD54-3072	132 lbs	WR54-3072-5	167 lbs	AD54-3072-5	165 lbs	Y	Y	Y
36" x 36"	WR54-3636	84 lbs	AD54-3636	80 lbs	WR54-3636-5	102 lbs	AD54-3636-5	100 lbs	Y	Y	Y
36" x 48"	WR54-3648	104 lbs	AD54-3648	100 lbs	WR54-3648-5	127 lbs	AD54-3648-5	125 lbs	Y	Y	Y
36" x 60"	WR54-3660	128 lbs	AD54-3660	124 lbs	WR54-3660-5	157 lbs	AD54-3660-5	155 lbs	Y	Y	Y
36" x 72"	WR54-3672	136 lbs	AD54-3672	132 lbs	WR54-3672-5	171 lbs	AD54-3672-5	169 lbs	Y	Y	Y

Shelving units include 4 posts and 4 or 5 shelves. Add-On units include 2 posts, 4 or 5 shelves and 8 or 10 S-Hooks.

Y (Yes) N (No)

Add-On Kits

Additional Add-On kit allows you to expand your Starter kit by sharing a set of posts. Configuration options include straight line, back to back and right angles (L-Shape). Add-On kits come complete with 2 posts, 4 or 5 shelves and 8 or 16 S-Hooks. Additional shelves may be purchased separately. See chart on pg. 38. Units with Add-On kit cannot be made mobile. **Finishes:** Chrome, Stainless Steel and Proform

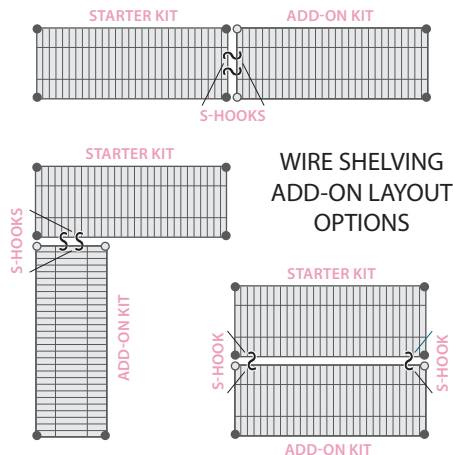



STARTER KITS

TO CHOOSE FINISH ADD FINISH SUFFIX TO MODEL NO.
 Example: Chrome WR63-1236C
 Stainless WR63-1236S
 Proform WR63-1236P

TO CHOOSE FINISH ADD FINISH SUFFIX TO MODEL NO.
 Example: Chrome WR63-1236C-5
 Stainless WR63-1236S-5
 Proform WR63-1236P-5

Chrome
 Stainless
 Proform

SHELF W" x L"	63"H WIRE SHELVING 4 SHELVES				63"H WIRE SHELVING 5 SHELVES				AVAILABLE FINISHES		
	STARTER KIT	ADD-ON KIT	STARTER KIT	ADD-ON KIT	STARTER KIT	ADD-ON KIT	STARTER KIT	ADD-ON KIT	C	S	P
12" x 36"	WR63-1236	AD63-1236	WR63-1236-5	AD63-1236-5	WR63-1236-5	AD63-1236-5	WR63-1236-5	AD63-1236-5	Y	Y	Y
12" x 42"	WR63-1242	AD63-1242	WR63-1242-5	AD63-1242-5	WR63-1242-5	AD63-1242-5	WR63-1242-5	AD63-1242-5	Y	N	N
12" x 48"	WR63-1248	AD63-1248	WR63-1248-5	AD63-1248-5	WR63-1248-5	AD63-1248-5	WR63-1248-5	AD63-1248-5	Y	Y	Y
12" x 60"	WR63-1260	AD63-1260	WR63-1260-5	AD63-1260-5	WR63-1260-5	AD63-1260-5	WR63-1260-5	AD63-1260-5	Y	Y	Y
12" x 72"	WR63-1272	AD63-1272	WR63-1272-5	AD63-1272-5	WR63-1272-5	AD63-1272-5	WR63-1272-5	AD63-1272-5	Y	Y	Y
14" x 24"	WR63-1424	AD63-1424	WR63-1424-5	AD63-1424-5	WR63-1424-5	AD63-1424-5	WR63-1424-5	AD63-1424-5	Y	N	N
14" x 30"	WR63-1430	AD63-1430	WR63-1430-5	AD63-1430-5	WR63-1430-5	AD63-1430-5	WR63-1430-5	AD63-1430-5	Y	Y	N
14" x 36"	WR63-1436	AD63-1436	WR63-1436-5	AD63-1436-5	WR63-1436-5	AD63-1436-5	WR63-1436-5	AD63-1436-5	Y	Y	Y
14" x 42"	WR63-1442	AD63-1442	WR63-1442-5	AD63-1442-5	WR63-1442-5	AD63-1442-5	WR63-1442-5	AD63-1442-5	Y	Y	N
14" x 48"	WR63-1448	AD63-1448	WR63-1448-5	AD63-1448-5	WR63-1448-5	AD63-1448-5	WR63-1448-5	AD63-1448-5	Y	Y	Y
14" x 54"	WR63-1454	AD63-1454	WR63-1454-5	AD63-1454-5	WR63-1454-5	AD63-1454-5	WR63-1454-5	AD63-1454-5	Y	Y	N
14" x 60"	WR63-1460	AD63-1460	WR63-1460-5	AD63-1460-5	WR63-1460-5	AD63-1460-5	WR63-1460-5	AD63-1460-5	Y	Y	Y
14" x 72"	WR63-1472	AD63-1472	WR63-1472-5	AD63-1472-5	WR63-1472-5	AD63-1472-5	WR63-1472-5	AD63-1472-5	Y	Y	Y
18" x 24"	WR63-1824	AD63-1824	WR63-1824-5	AD63-1824-5	WR63-1824-5	AD63-1824-5	WR63-1824-5	AD63-1824-5	Y	Y	N
18" x 30"	WR63-1830	AD63-1830	WR63-1830-5	AD63-1830-5	WR63-1830-5	AD63-1830-5	WR63-1830-5	AD63-1830-5	Y	Y	Y
18" x 36"	WR63-1836	AD63-1836	WR63-1836-5	AD63-1836-5	WR63-1836-5	AD63-1836-5	WR63-1836-5	AD63-1836-5	Y	Y	Y
18" x 42"	WR63-1842	AD63-1842	WR63-1842-5	AD63-1842-5	WR63-1842-5	AD63-1842-5	WR63-1842-5	AD63-1842-5	Y	Y	Y
18" x 48"	WR63-1848	AD63-1848	WR63-1848-5	AD63-1848-5	WR63-1848-5	AD63-1848-5	WR63-1848-5	AD63-1848-5	Y	Y	Y
18" x 54"	WR63-1854	AD63-1854	WR63-1854-5	AD63-1854-5	WR63-1854-5	AD63-1854-5	WR63-1854-5	AD63-1854-5	Y	Y	Y
18" x 60"	WR63-1860	AD63-1860	WR63-1860-5	AD63-1860-5	WR63-1860-5	AD63-1860-5	WR63-1860-5	AD63-1860-5	Y	Y	Y
18" x 72"	WR63-1872	AD63-1872	WR63-1872-5	AD63-1872-5	WR63-1872-5	AD63-1872-5	WR63-1872-5	AD63-1872-5	Y	Y	Y
21" x 24"	WR63-2124	AD63-2124	WR63-2124-5	AD63-2124-5	WR63-2124-5	AD63-2124-5	WR63-2124-5	AD63-2124-5	Y	Y	N
21" x 30"	WR63-2130	AD63-2130	WR63-2130-5	AD63-2130-5	WR63-2130-5	AD63-2130-5	WR63-2130-5	AD63-2130-5	Y	Y	N
21" x 36"	WR63-2136	AD63-2136	WR63-2136-5	AD63-2136-5	WR63-2136-5	AD63-2136-5	WR63-2136-5	AD63-2136-5	Y	Y	Y
21" x 42"	WR63-2142	AD63-2142	WR63-2142-5	AD63-2142-5	WR63-2142-5	AD63-2142-5	WR63-2142-5	AD63-2142-5	Y	Y	N
21" x 48"	WR63-2148	AD63-2148	WR63-2148-5	AD63-2148-5	WR63-2148-5	AD63-2148-5	WR63-2148-5	AD63-2148-5	Y	Y	Y
21" x 54"	WR63-2154	AD63-2154	WR63-2154-5	AD63-2154-5	WR63-2154-5	AD63-2154-5	WR63-2154-5	AD63-2154-5	Y	Y	N
21" x 60"	WR63-2160	AD63-2160	WR63-2160-5	AD63-2160-5	WR63-2160-5	AD63-2160-5	WR63-2160-5	AD63-2160-5	Y	Y	Y
21" x 72"	WR63-2172	AD63-2172	WR63-2172-5	AD63-2172-5	WR63-2172-5	AD63-2172-5	WR63-2172-5	AD63-2172-5	Y	Y	Y
24" x 24"	WR63-2424	AD63-2424	WR63-2424-5	AD63-2424-5	WR63-2424-5	AD63-2424-5	WR63-2424-5	AD63-2424-5	Y	Y	N
24" x 30"	WR63-2430	AD63-2430	WR63-2430-5	AD63-2430-5	WR63-2430-5	AD63-2430-5	WR63-2430-5	AD63-2430-5	Y	Y	Y
24" x 36"	WR63-2436	AD63-2436	WR63-2436-5	AD63-2436-5	WR63-2436-5	AD63-2436-5	WR63-2436-5	AD63-2436-5	Y	Y	Y
24" x 42"	WR63-2442	AD63-2442	WR63-2442-5	AD63-2442-5	WR63-2442-5	AD63-2442-5	WR63-2442-5	AD63-2442-5	Y	Y	Y
24" x 48"	WR63-2448	AD63-2448	WR63-2448-5	AD63-2448-5	WR63-2448-5	AD63-2448-5	WR63-2448-5	AD63-2448-5	Y	Y	Y
24" x 54"	WR63-2454	AD63-2454	WR63-2454-5	AD63-2454-5	WR63-2454-5	AD63-2454-5	WR63-2454-5	AD63-2454-5	Y	Y	Y
24" x 60"	WR63-2460	AD63-2460	WR63-2460-5	AD63-2460-5	WR63-2460-5	AD63-2460-5	WR63-2460-5	AD63-2460-5	Y	Y	Y
24" x 72"	WR63-2472	AD63-2472	WR63-2472-5	AD63-2472-5	WR63-2472-5	AD63-2472-5	WR63-2472-5	AD63-2472-5	Y	Y	Y
30" x 36"	WR63-3036	AD63-3036	WR63-3036-5	AD63-3036-5	WR63-3036-5	AD63-3036-5	WR63-3036-5	AD63-3036-5	Y	Y	Y
30" x 42"	WR63-3042	AD63-3042	WR63-3042-5	AD63-3042-5	WR63-3042-5	AD63-3042-5	WR63-3042-5	AD63-3042-5	Y	Y	Y
30" x 48"	WR63-3048	AD63-3048	WR63-3048-5	AD63-3048-5	WR63-3048-5	AD63-3048-5	WR63-3048-5	AD63-3048-5	Y	Y	Y
30" x 60"	WR63-3060	AD63-3060	WR63-3060-5	AD63-3060-5	WR63-3060-5	AD63-3060-5	WR63-3060-5	AD63-3060-5	Y	Y	Y
30" x 72"	WR63-3072	AD63-3072	WR63-3072-5	AD63-3072-5	WR63-3072-5	AD63-3072-5	WR63-3072-5	AD63-3072-5	Y	Y	Y
36" x 36"	WR63-3636	AD63-3636	WR63-3636-5	AD63-3636-5	WR63-3636-5	AD63-3636-5	WR63-3636-5	AD63-3636-5	Y	Y	Y
36" x 48"	WR63-3648	AD63-3648	WR63-3648-5	AD63-3648-5	WR63-3648-5	AD63-3648-5	WR63-3648-5	AD63-3648-5	Y	Y	Y
36" x 60"	WR63-3660	AD63-3660	WR63-3660-5	AD63-3660-5	WR63-3660-5	AD63-3660-5	WR63-3660-5	AD63-3660-5	Y	Y	Y
36" x 72"	WR63-3672	AD63-3672	WR63-3672-5	AD63-3672-5	WR63-3672-5	AD63-3672-5	WR63-3672-5	AD63-3672-5	Y	Y	Y

Shelving units include 4 posts and 4 or 5 shelves. Add-On units include 2 posts, 4 or 5 shelves and 8 or 10 S-Hooks. Y (Yes) N (No)

Starter Kits

Heavy-duty shelving unit allows up to 800 lb. shelf capacity. Starter kits come complete with 4 posts and 4 or 5 shelves. Additional shelves may be purchased separately. See chart on pg. 38. Mobilize starter kit shelving unit using optional mobile kit **WR-00H**. See pg. 79. **Finishes:** Chrome, Stainless Steel and Proform



MOBILIZE YOUR WIRE SHELVING

DB - Donut Bumper
 Non-marking donut bumper used to protect walls and help cushion impact.

WR-00H (Mobile Kit)*
 Set of four swivel polyurethane 5" x 1-1/4" casters, two with brakes. Can be used with all units shown. 1,200 lb. load capacity. *Mobile kits recommended only for shelves 18" and wider.



S-HOOKS
 For continuous runs of shelving. Two hooks should be placed per shelf where two posts are not utilized.

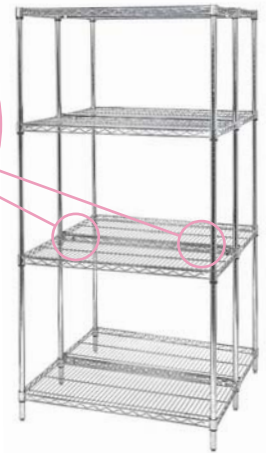

BACK TO BACK UNIT

Add-On Kits

Additional Add-On kit allows you to expand your Starter kit by sharing a set of posts. Configuration options include straight line, back to back and right angles (L-Shape). Add-On kits come complete with 2 posts, 4 or 5 shelves and 8 or 16 S-Hooks. Additional shelves may be purchased separately. See chart on pg. 38. Units with Add-On kit cannot be made mobile. **Finishes:** Chrome, Stainless Steel and Proform

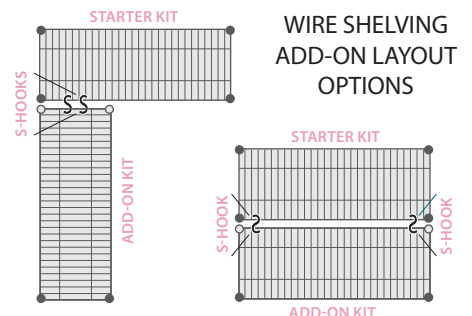
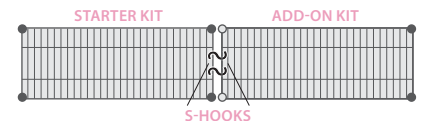



Starter Kits

Heavy-duty shelving unit allows up to 800 lb. shelf capacity. Starter kits come complete with 4 posts and 4 or 5 shelves. Additional shelves may be purchased separately. See chart on pg. 38. Mobilize starter kit shelving unit using optional mobile kit **WR-00H**. See pg. 79. **Finishes:** Chrome, Stainless Steel and Proform



STARTER KITS



MOBILIZE YOUR WIRE SHELVING

DB - Donut Bumper

Non-marking donut bumper used to protect walls and help cushion impact.

WR-00H (Mobile Kit)*

Set of four swivel polyurethane 5" x 1-1/4" casters, two with brakes. Can be used with all units shown. 1,200 lb. load capacity. *Mobile kits recommended only for shelves 18" and wider.



S-HOOKS

For continuous runs of shelving. Two hooks should be placed per shelf where two posts are not utilized.

L SHAPE UNIT

Add-On Kits

Additional Add-On kit allows you to expand your Starter kit by sharing a set of posts. Configuration options include straight line, back to back and right angles (L-Shape). Add-On kits come complete with 2 posts, 4 or 5 shelves and 8 or 16 S-Hooks. Additional shelves may be purchased separately. See chart on pg. 38. Units with Add-On kit cannot be made mobile. **Finishes:** Chrome, Stainless Steel and Proform

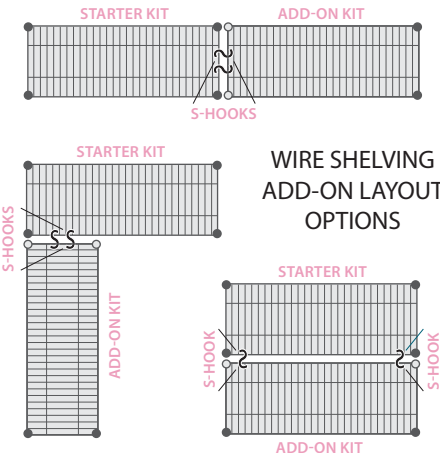

WIRE SHELVING ADD-ON LAYOUT OPTIONS

TO CHOOSE FINISH ADD FINISH SUFFIX TO MODEL NO.
Example: Chrome WR74-1236C
Stainless WR74-1236S
Proform WR74-1236P

TO CHOOSE FINISH ADD FINISH SUFFIX TO MODEL NO.
Example: Chrome WR74-1236C-5
Stainless WR74-1236S-5
Proform WR74-1236P-5

Chrome
Stainless
Proform

SHELF W" x L"	74"H WIRE SHELVING 4 SHELVES				74"H WIRE SHELVING 5 SHELVES				AVAILABLE		
	STARTER KIT	MODEL NO.	SHIP WGT	ADD-ON KIT	MODEL NO.	SHIP WGT	STARTER KIT	ADD-ON KIT	SHIP WGT	C	S
12" x 36"	WR74-1236	44 lbs	AD74-1236	38 lbs	WR74-1236-5	51 lbs	AD74-1236-5	47 lbs	Y	Y	Y
12" x 42"	WR74-1242	48 lbs	AD74-1242	42 lbs	WR74-1242-5	56 lbs	AD74-1242-5	52 lbs	Y	N	N
12" x 48"	WR74-1248	52 lbs	AD74-1248	46 lbs	WR74-1248-5	61 lbs	AD74-1248-5	57 lbs	Y	Y	Y
12" x 60"	WR74-1260	60 lbs	AD74-1260	54 lbs	WR74-1260-5	74 lbs	AD74-1260-5	70 lbs	Y	Y	Y
12" x 72"	WR74-1272	68 lbs	AD74-1272	62 lbs	WR74-1272-5	85 lbs	AD74-1272-5	81 lbs	Y	Y	Y
14" x 24"	WR74-1424	40 lbs	AD74-1424	34 lbs	WR74-1424-5	46 lbs	AD74-1424-5	42 lbs	Y	N	N
14" x 30"	WR74-1430	44 lbs	AD74-1430	38 lbs	WR74-1430-5	51 lbs	AD74-1430-5	47 lbs	Y	Y	N
14" x 36"	WR74-1436	48 lbs	AD74-1436	42 lbs	WR74-1436-5	56 lbs	AD74-1436-5	52 lbs	Y	Y	Y
14" x 42"	WR74-1442	56 lbs	AD74-1442	50 lbs	WR74-1442-5	66 lbs	AD74-1442-5	62 lbs	Y	Y	N
14" x 48"	WR74-1448	60 lbs	AD74-1448	54 lbs	WR74-1448-5	71 lbs	AD74-1448-5	67 lbs	Y	Y	Y
14" x 54"	WR74-1454	64 lbs	AD74-1454	58 lbs	WR74-1454-5	76 lbs	AD74-1454-5	72 lbs	Y	Y	N
14" x 60"	WR74-1460	72 lbs	AD74-1460	66 lbs	WR74-1460-5	86 lbs	AD74-1460-5	82 lbs	Y	Y	Y
14" x 72"	WR74-1472	84 lbs	AD74-1472	78 lbs	WR74-1472-5	101 lbs	AD74-1472-5	97 lbs	Y	Y	Y
18" x 24"	WR74-1824	44 lbs	AD74-1824	38 lbs	WR74-1824-5	51 lbs	AD74-1824-5	47 lbs	Y	Y	N
18" x 30"	WR74-1830	48 lbs	AD74-1830	42 lbs	WR74-1830-5	56 lbs	AD74-1830-5	52 lbs	Y	Y	Y
18" x 36"	WR74-1836	56 lbs	AD74-1836	50 lbs	WR74-1836-5	66 lbs	AD74-1836-5	62 lbs	Y	Y	Y
18" x 42"	WR74-1842	60 lbs	AD74-1842	54 lbs	WR74-1842-5	71 lbs	AD74-1842-5	67 lbs	Y	Y	Y
18" x 48"	WR74-1848	64 lbs	AD74-1848	58 lbs	WR74-1848-5	78 lbs	AD74-1848-5	74 lbs	Y	Y	Y
18" x 54"	WR74-1854	76 lbs	AD74-1854	70 lbs	WR74-1854-5	91 lbs	AD74-1854-5	87 lbs	Y	Y	Y
18" x 60"	WR74-1860	84 lbs	AD74-1860	78 lbs	WR74-1860-5	101 lbs	AD74-1860-5	97 lbs	Y	Y	Y
18" x 72"	WR74-1872	96 lbs	AD74-1872	90 lbs	WR74-1872-5	116 lbs	AD74-1872-5	112 lbs	Y	Y	Y
21" x 24"	WR74-2124	48 lbs	AD74-2124	42 lbs	WR74-2124-5	56 lbs	AD74-2124-5	52 lbs	Y	Y	N
21" x 30"	WR74-2130	52 lbs	AD74-2130	46 lbs	WR74-2130-5	61 lbs	AD74-2130-5	57 lbs	Y	Y	N
21" x 36"	WR74-2136	60 lbs	AD74-2136	54 lbs	WR74-2136-5	71 lbs	AD74-2136-5	67 lbs	Y	Y	Y
21" x 42"	WR74-2142	64 lbs	AD74-2142	58 lbs	WR74-2142-5	76 lbs	AD74-2142-5	72 lbs	Y	Y	N
21" x 48"	WR74-2148	72 lbs	AD74-2148	66 lbs	WR74-2148-5	86 lbs	AD74-2148-5	82 lbs	Y	Y	Y
21" x 54"	WR74-2154	80 lbs	AD74-2154	74 lbs	WR74-2154-5	96 lbs	AD74-2154-5	92 lbs	Y	Y	N
21" x 60"	WR74-2160	88 lbs	AD74-2160	82 lbs	WR74-2160-5	106 lbs	AD74-2160-5	102 lbs	Y	Y	Y
21" x 72"	WR74-2172	112 lbs	AD74-2172	106 lbs	WR74-2172-5	136 lbs	AD74-2172-5	132 lbs	Y	Y	Y
24" x 24"	WR74-2424	52 lbs	AD74-2424	46 lbs	WR74-2424-5	61 lbs	AD74-2424-5	57 lbs	Y	Y	N
24" x 30"	WR74-2430	60 lbs	AD74-2430	54 lbs	WR74-2430-5	71 lbs	AD74-2430-5	67 lbs	Y	Y	Y
24" x 36"	WR74-2436	68 lbs	AD74-2436	62 lbs	WR74-2436-5	81 lbs	AD74-2436-5	77 lbs	Y	Y	Y
24" x 42"	WR74-2442	76 lbs	AD74-2442	70 lbs	WR74-2442-5	91 lbs	AD74-2442-5	87 lbs	Y	Y	Y
24" x 48"	WR74-2448	80 lbs	AD74-2448	74 lbs	WR74-2448-5	96 lbs	AD74-2448-5	92 lbs	Y	Y	Y
24" x 54"	WR74-2454	88 lbs	AD74-2454	82 lbs	WR74-2454-5	106 lbs	AD74-2454-5	102 lbs	Y	Y	Y
24" x 60"	WR74-2460	100 lbs	AD74-2460	94 lbs	WR74-2460-5	121 lbs	AD74-2460-5	117 lbs	Y	Y	Y
24" x 72"	WR74-2472	120 lbs	AD74-2472	114 lbs	WR74-2472-5	146 lbs	AD74-2472-5	142 lbs	Y	Y	Y
30" x 36"	WR74-3036	76 lbs	AD74-3036	70 lbs	WR74-3036-5	91 lbs	AD74-3036-5	87 lbs	Y	Y	Y
30" x 42"	WR74-3042	88 lbs	AD74-3042	82 lbs	WR74-3042-5	106 lbs	AD74-3042-5	102 lbs	Y	Y	Y
30" x 48"	WR74-3048	100 lbs	AD74-3048	94 lbs	WR74-3048-5	121 lbs	AD74-3048-5	117 lbs	Y	Y	Y
30" x 60"	WR74-3060	124 lbs	AD74-3060	118 lbs	WR74-3060-5	151 lbs	AD74-3060-5	147 lbs	Y	Y	Y
30" x 72"	WR74-3072	140 lbs	AD74-3072	134 lbs	WR74-3072-5	171 lbs	AD74-3072-5	167 lbs	Y	Y	Y
36" x 36"	WR74-3636	88 lbs	AD74-3636	82 lbs	WR74-3636-5	106 lbs	AD74-3636-5	102 lbs	Y	Y	Y
36" x 48"	WR74-3648	108 lbs	AD74-3648	102 lbs	WR74-3648-5	131 lbs	AD74-3648-5	127 lbs	Y	Y	Y
36" x 60"	WR74-3660	132 lbs	AD74-3660	126 lbs	WR74-3660-5	161 lbs	AD74-3660-5	157 lbs	Y	Y	Y
36" x 72"	WR74-3672	140 lbs	AD74-3672	134 lbs	WR74-3672-5	175 lbs	AD74-3672-5	171 lbs	Y	Y	Y

Shelving units include 4 posts and 4 or 5 shelves. Add-On units include 2 posts, 4 or 5 shelves and 8 or 10 S-Hooks. Y (Yes) N (No)



STARTER KITS

TO CHOOSE FINISH ADD FINISH SUFFIX TO MODEL NO.
 Example: Chrome WR86-1236C
 Stainless WR86-1236S
 Proform WR86-1236P

TO CHOOSE FINISH ADD FINISH SUFFIX TO MODEL NO.
 Example: Chrome WR86-1236C-5
 Stainless WR86-1236S-5
 Proform WR86-1236P-5

Chrome
 Stainless
 Proform

SHELF W" x L"	86"H WIRE SHELVING 4 SHELVES				86"H WIRE SHELVING 5 SHELVES				AVAILABLE FINISHES		
	STARTER KIT	ADD-ON KIT	STARTER KIT	ADD-ON KIT	STARTER KIT	ADD-ON KIT	STARTER KIT	ADD-ON KIT	C	S	P
12" x 36"	WR86-1236	48 lbs	AD86-1236	40 lbs	WR86-1236-5	55 lbs	AD86-1236-5	49 lbs	Y	Y	Y
12" x 42"	WR86-1242	52 lbs	AD86-1242	44 lbs	WR86-1242-5	60 lbs	AD86-1242-5	54 lbs	Y	N	N
12" x 48"	WR86-1248	56 lbs	AD86-1248	48 lbs	WR86-1248-5	65 lbs	AD86-1248-5	59 lbs	Y	Y	Y
12" x 60"	WR86-1260	64 lbs	AD86-1260	56 lbs	WR86-1260-5	78 lbs	AD86-1260-5	72 lbs	Y	Y	Y
12" x 72"	WR86-1272	72 lbs	AD86-1272	64 lbs	WR86-1272-5	89 lbs	AD86-1272-5	83 lbs	Y	Y	Y
14" x 24"	WR86-1424	44 lbs	AD86-1424	36 lbs	WR86-1424-5	50 lbs	AD86-1424-5	44 lbs	Y	N	N
14" x 30"	WR86-1430	48 lbs	AD86-1430	40 lbs	WR86-1430-5	55 lbs	AD86-1430-5	49 lbs	Y	Y	N
14" x 36"	WR86-1436	52 lbs	AD86-1436	44 lbs	WR86-1436-5	60 lbs	AD86-1436-5	54 lbs	Y	Y	Y
14" x 42"	WR86-1442	60 lbs	AD86-1442	52 lbs	WR86-1442-5	70 lbs	AD86-1442-5	64 lbs	Y	Y	N
14" x 48"	WR86-1448	64 lbs	AD86-1448	56 lbs	WR86-1448-5	75 lbs	AD86-1448-5	69 lbs	Y	Y	Y
14" x 54"	WR86-1454	68 lbs	AD86-1454	60 lbs	WR86-1454-5	80 lbs	AD86-1454-5	74 lbs	Y	Y	N
14" x 60"	WR86-1460	76 lbs	AD86-1460	68 lbs	WR86-1460-5	90 lbs	AD86-1460-5	84 lbs	Y	Y	Y
14" x 72"	WR86-1472	88 lbs	AD86-1472	80 lbs	WR86-1472-5	105 lbs	AD86-1472-5	99 lbs	Y	Y	Y
18" x 24"	WR86-1824	48 lbs	AD86-1824	40 lbs	WR86-1824-5	55 lbs	AD86-1824-5	49 lbs	Y	Y	N
18" x 30"	WR86-1830	52 lbs	AD86-1830	44 lbs	WR86-1830-5	60 lbs	AD86-1830-5	54 lbs	Y	Y	Y
18" x 36"	WR86-1836	60 lbs	AD86-1836	52 lbs	WR86-1836-5	60 lbs	AD86-1836-5	64 lbs	Y	Y	Y
18" x 42"	WR86-1842	64 lbs	AD86-1842	56 lbs	WR86-1842-5	75 lbs	AD86-1842-5	69 lbs	Y	Y	Y
18" x 48"	WR86-1848	68 lbs	AD86-1848	60 lbs	WR86-1848-5	82 lbs	AD86-1848-5	76 lbs	Y	Y	Y
18" x 54"	WR86-1854	80 lbs	AD86-1854	72 lbs	WR86-1854-5	95 lbs	AD86-1854-5	89 lbs	Y	Y	Y
18" x 60"	WR86-1860	88 lbs	AD86-1860	80 lbs	WR86-1860-5	105 lbs	AD86-1860-5	99 lbs	Y	Y	Y
18" x 72"	WR86-1872	100 lbs	AD86-1872	92 lbs	WR86-1872-5	120 lbs	AD86-1872-5	114 lbs	Y	Y	Y
21" x 24"	WR86-2124	52 lbs	AD86-2124	44 lbs	WR86-2124-5	60 lbs	AD86-2124-5	54 lbs	Y	Y	N
21" x 30"	WR86-2130	56 lbs	AD86-2130	48 lbs	WR86-2130-5	65 lbs	AD86-2130-5	59 lbs	Y	Y	N
21" x 36"	WR86-2136	64 lbs	AD86-2136	56 lbs	WR86-2136-5	75 lbs	AD86-2136-5	69 lbs	Y	Y	Y
21" x 42"	WR86-2142	68 lbs	AD86-2142	60 lbs	WR86-2142-5	80 lbs	AD86-2142-5	74 lbs	Y	Y	N
21" x 48"	WR86-2148	76 lbs	AD86-2148	68 lbs	WR86-2148-5	90 lbs	AD86-2148-5	84 lbs	Y	Y	Y
21" x 54"	WR86-2154	84 lbs	AD86-2154	76 lbs	WR86-2154-5	100 lbs	AD86-2154-5	94 lbs	Y	Y	N
21" x 60"	WR86-2160	92 lbs	AD86-2160	84 lbs	WR86-2160-5	110 lbs	AD86-2160-5	104 lbs	Y	Y	Y
21" x 72"	WR86-2172	116 lbs	AD86-2172	108 lbs	WR86-2172-5	140 lbs	AD86-2172-5	134 lbs	Y	Y	Y
24" x 24"	WR86-2424	56 lbs	AD86-2424	48 lbs	WR86-2424-5	65 lbs	AD86-2424-5	59 lbs	Y	Y	N
24" x 30"	WR86-2430	64 lbs	AD86-2430	56 lbs	WR86-2430-5	75 lbs	AD86-2430-5	69 lbs	Y	Y	Y
24" x 36"	WR86-2436	72 lbs	AD86-2436	64 lbs	WR86-2436-5	85 lbs	AD86-2436-5	79 lbs	Y	Y	Y
24" x 42"	WR86-2442	80 lbs	AD86-2442	72 lbs	WR86-2442-5	95 lbs	AD86-2442-5	89 lbs	Y	Y	Y
24" x 48"	WR86-2448	84 lbs	AD86-2448	76 lbs	WR86-2448-5	100 lbs	AD86-2448-5	94 lbs	Y	Y	Y
24" x 54"	WR86-2454	92 lbs	AD86-2454	84 lbs	WR86-2454-5	110 lbs	AD86-2454-5	104 lbs	Y	Y	Y
24" x 60"	WR86-2460	104 lbs	AD86-2460	96 lbs	WR86-2460-5	125 lbs	AD86-2460-5	119 lbs	Y	Y	Y
24" x 72"	WR86-2472	124 lbs	AD86-2472	116 lbs	WR86-2472-5	150 lbs	AD86-2472-5	144 lbs	Y	Y	Y
30" x 36"	WR86-3036	80 lbs	AD86-3036	72 lbs	WR86-3036-5	95 lbs	AD86-3036-5	89 lbs	Y	Y	Y
30" x 42"	WR86-3042	92 lbs	AD86-3042	84 lbs	WR86-3042-5	110 lbs	AD86-3042-5	104 lbs	Y	Y	Y
30" x 48"	WR86-3048	104 lbs	AD86-3048	96 lbs	WR86-3048-5	125 lbs	AD86-3048-5	119 lbs	Y	Y	Y
30" x 60"	WR86-3060	128 lbs	AD86-3060	120 lbs	WR86-3060-5	155 lbs	AD86-3060-5	149 lbs	Y	Y	Y
30" x 72"	WR86-3072	144 lbs	AD86-3072	136 lbs	WR86-3072-5	175 lbs	AD86-3072-5	169 lbs	Y	Y	Y
36" x 36"	WR86-3636	92 lbs	AD86-3636	84 lbs	WR86-3636-5	110 lbs	AD86-3636-5	104 lbs	Y	Y	Y
36" x 48"	WR86-3648	112 lbs	AD86-3648	104 lbs	WR86-3648-5	135 lbs	AD86-3648-5	129 lbs	Y	Y	Y
36" x 60"	WR86-3660	136 lbs	AD86-3660	128 lbs	WR86-3660-5	165 lbs	AD86-3660-5	159 lbs	Y	Y	Y
36" x 72"	WR86-3672	144 lbs	AD86-3672	136 lbs	WR86-3672-5	179 lbs	AD86-3672-5	173 lbs	Y	Y	Y

Shelving units include 4 posts and 4 or 5 shelves. Add-On units include 2 posts, 4 or 5 shelves and 8 or 10 S-Hooks. Y (Yes) N (No)

Starter Kits

Heavy-duty shelving unit allows up to 800 lb. shelf capacity. Starter kits come complete with 4 posts and 4 or 5 shelves. Additional shelves may be purchased separately. See chart on pg. 38. Mobilize starter kit shelving unit using optional mobile kit **WR-00H**. See pg. 79. **Finishes:** Chrome, Stainless Steel and Proform



MOBILIZE YOUR WIRE SHELVING

DB - Donut Bumper
 Non-marking donut bumper used to protect walls and help cushion impact.

WR-00H (Mobile Kit)*
 Set of four swivel polyurethane 5" x 1-1/4" casters, two with brakes. Can be used with all units shown. 1,200 lb. load capacity. *Mobile kits recommended only for shelves 18" and wider.

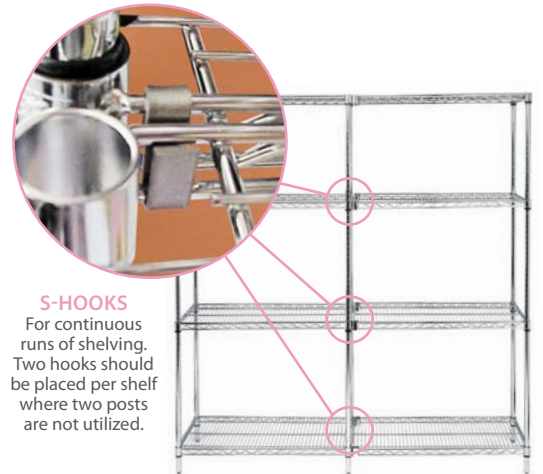

S-HOOKS

For continuous runs of shelving. Two hooks should be placed per shelf where two posts are not utilized.

BACK TO BACK UNIT

Add-On Kits

Additional Add-On kit allows you to expand your Starter kit by sharing a set of posts. Configuration options include straight line, back to back and right angles (L-Shape). Add-On kits come complete with 2 posts, 4 or 5 shelves and 8 or 16 S-Hooks. Additional shelves may be purchased separately. See chart on pg. 38. Units with Add-On kit cannot be made mobile. **Finishes:** Chrome, Stainless Steel and Proform

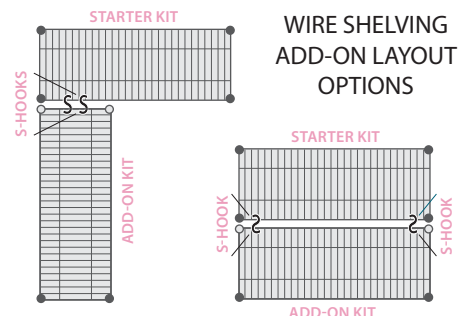
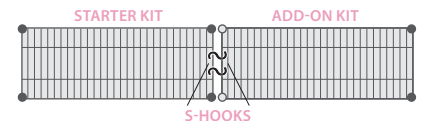



4 Shelf Starter Kits

Solid shelves are a solution where dirt, dust and spills are a potential issue. The solid flat surface allows for storage from small to large items and the marine edge perimeter prevents spillage. The double hemmed 18 gauge 304 stainless steel gives the solid shelf excellent strength characteristics. All solid shelf units consist of 4 shelves and 4 posts. Mobilize starter kit shelving unit using optional mobile kit **WR-00H**. See pg. 79. **Finish:** Stainless Steel



MOBILIZE YOUR SHELVING

DB - Donut Bumper

Non-marking donut bumper used to protect walls and help cushion impact.

WR-00H (Mobile Kit)*

Set of four swivel polyurethane 5" x 1-1/4" casters, two with brakes. Can be used with all units shown. 1,200 lb. load capacity. *Mobile kits recommended only for shelves 18" and wider.



STARTER KIT



QSMC Shelf Clamp

Shelf Clamp eliminates 2 post per shelving section. Two QSMC clamps are required per shelf. **Finish:** Aluminum

4 Shelf Add-On Kits

Additional Add-On kit allows you to expand your Starter kit by sharing a set of posts. Configuration options include straight line, back to back and right angles (L-Shape). Add-On units consist of 4 shelves, 2 posts and 8 shelf clamps. Additional shelves may be purchased separately. See chart on pg. 39. Units with Add-On kit cannot be made mobile. **Finish:** Stainless Steel

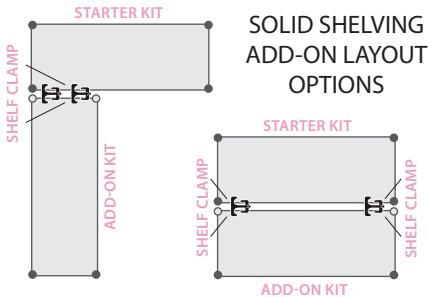
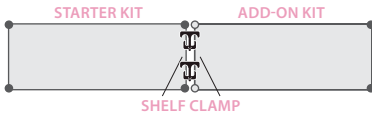

54"H STAINLESS SOLID SHELVING 4 SHELVES					63"H STAINLESS SOLID SHELVING 4 SHELVES				
STARTER KIT			ADD-ON KIT		STARTER KIT			ADD-ON KIT	
SHELF W" x L"	MODEL NO.	SHIP WGT	MODEL NO.	SHIP WGT	MODEL NO.	SHIP WGT	MODEL NO.	SHIP WGT	SHIP WGT
14" x 36"	WRS4-54-1436SS	68 lbs	WRSAD4-54-1436SS	65 lbs	WRS4-63-1436SS	72 lbs	WRSAD4-63-1436SS	67 lbs	
14" x 42"	WRS4-54-1442SS	72 lbs	WRSAD4-54-1442SS	69 lbs	WRS4-63-1442SS	76 lbs	WRSAD4-63-1442SS	71 lbs	
14" x 48"	WRS4-54-1448SS	80 lbs	WRSAD4-54-1448SS	77 lbs	WRS4-63-1448SS	84 lbs	WRSAD4-63-1448SS	79 lbs	
14" x 54"	WRS4-54-1454SS	92 lbs	WRSAD4-54-1454SS	89 lbs	WRS4-63-1454SS	96 lbs	WRSAD4-63-1454SS	91 lbs	
14" x 60"	WRS4-54-1460SS	100 lbs	WRSAD4-54-1460SS	97 lbs	WRS4-63-1460SS	104 lbs	WRSAD4-63-1460SS	99 lbs	
14" x 72"	WRS4-54-1472SS	116 lbs	WRSAD4-54-1472SS	113 lbs	WRS4-63-1472SS	120 lbs	WRSAD4-63-1472SS	115 lbs	
18" x 24"	WRS4-54-1824SS	56 lbs	WRSAD4-54-1824SS	53 lbs	WRS4-63-1824SS	60 lbs	WRSAD4-63-1824SS	55 lbs	
18" x 30"	WRS4-54-1830SS	68 lbs	WRSAD4-54-1830SS	65 lbs	WRS4-63-1830SS	72 lbs	WRSAD4-63-1830SS	67 lbs	
18" x 36"	WRS4-54-1836SS	76 lbs	WRSAD4-54-1836SS	73 lbs	WRS4-63-1836SS	80 lbs	WRSAD4-63-1836SS	75 lbs	
18" x 42"	WRS4-54-1842SS	84 lbs	WRSAD4-54-1842SS	81 lbs	WRS4-63-1842SS	88 lbs	WRSAD4-63-1842SS	83 lbs	
18" x 48"	WRS4-54-1848SS	92 lbs	WRSAD4-54-1848SS	89 lbs	WRS4-63-1848SS	96 lbs	WRSAD4-63-1848SS	91 lbs	
18" x 54"	WRS4-54-1854SS	100 lbs	WRSAD4-54-1854SS	97 lbs	WRS4-63-1854SS	104 lbs	WRSAD4-63-1854SS	99 lbs	
18" x 60"	WRS4-54-1860SS	108 lbs	WRSAD4-54-1860SS	105 lbs	WRS4-63-1860SS	112 lbs	WRSAD4-63-1860SS	107 lbs	
18" x 72"	WRS4-54-1872SS	120 lbs	WRSAD4-54-1872SS	117 lbs	WRS4-63-1872SS	124 lbs	WRSAD4-63-1872SS	119 lbs	
21" x 24"	WRS4-54-2124SS	64 lbs	WRSAD4-54-2124SS	61 lbs	WRS4-63-2124SS	68 lbs	WRSAD4-63-2124SS	63 lbs	
21" x 30"	WRS4-54-2130SS	72 lbs	WRSAD4-54-2130SS	69 lbs	WRS4-63-2130SS	76 lbs	WRSAD4-63-2130SS	71 lbs	
21" x 36"	WRS4-54-2136SS	84 lbs	WRSAD4-54-2136SS	81 lbs	WRS4-63-2136SS	88 lbs	WRSAD4-63-2136SS	83 lbs	
21" x 42"	WRS4-54-2142SS	96 lbs	WRSAD4-54-2142SS	93 lbs	WRS4-63-2142SS	100 lbs	WRSAD4-63-2142SS	95 lbs	
21" x 48"	WRS4-54-2148SS	104 lbs	WRSAD4-54-2148SS	101 lbs	WRS4-63-2148SS	108 lbs	WRSAD4-63-2148SS	103 lbs	
21" x 54"	WRS4-54-2154SS	112 lbs	WRSAD4-54-2154SS	109 lbs	WRS4-63-2154SS	116 lbs	WRSAD4-63-2154SS	111 lbs	
21" x 60"	WRS4-54-2160SS	124 lbs	WRSAD4-54-2160SS	121 lbs	WRS4-63-2160SS	128 lbs	WRSAD4-63-2160SS	123 lbs	
21" x 72"	WRS4-54-2172SS	132 lbs	WRSAD4-54-2172SS	129 lbs	WRS4-63-2172SS	136 lbs	WRSAD4-63-2172SS	131 lbs	
24" x 24"	WRS4-54-2424SS	72 lbs	WRSAD4-54-2424SS	69 lbs	WRS4-63-2424SS	76 lbs	WRSAD4-63-2424SS	71 lbs	
24" x 30"	WRS4-54-2430SS	80 lbs	WRSAD4-54-2430SS	77 lbs	WRS4-63-2430SS	84 lbs	WRSAD4-63-2430SS	79 lbs	
24" x 36"	WRS4-54-2436SS	88 lbs	WRSAD4-54-2436SS	85 lbs	WRS4-63-2436SS	92 lbs	WRSAD4-63-2436SS	87 lbs	
24" x 42"	WRS4-54-2442SS	100 lbs	WRSAD4-54-2442SS	97 lbs	WRS4-63-2442SS	104 lbs	WRSAD4-63-2442SS	99 lbs	
24" x 48"	WRS4-54-2448SS	108 lbs	WRSAD4-54-2448SS	105 lbs	WRS4-63-2448SS	112 lbs	WRSAD4-63-2448SS	107 lbs	
24" x 54"	WRS4-54-2454SS	124 lbs	WRSAD4-54-2454SS	121 lbs	WRS4-63-2454SS	128 lbs	WRSAD4-63-2454SS	123 lbs	
24" x 60"	WRS4-54-2460SS	136 lbs	WRSAD4-54-2460SS	133 lbs	WRS4-63-2460SS	140 lbs	WRSAD4-63-2460SS	135 lbs	
24" x 72"	WRS4-54-2472SS	148 lbs	WRSAD4-54-2472SS	145 lbs	WRS4-63-2472SS	152 lbs	WRSAD4-63-2472SS	147 lbs	

Shelving units include 4 posts and 4 shelves. Add-On units include 2 posts, 4 shelves and 8 shelf clamps.

18 Gauge 304 Stainless Steel

74"H STAINLESS SOLID SHELVING 4 SHELVES					86"H STAINLESS SOLID SHELVING 4 SHELVES				
STARTER KIT			ADD-ON KIT		STARTER KIT			ADD-ON KIT	
SHELF W" x L"	MODEL NO.	SHIP WGT	MODEL NO.	SHIP WGT	MODEL NO.	SHIP WGT	MODEL NO.	SHIP WGT	SHIP WGT
14" x 36"	WRS4-74-1436SS	72 lbs	WRSAD4-74-1436SS	67 lbs	WRS4-86-1436SS	76 lbs	WRSAD4-86-1436SS	69 lbs	
14" x 42"	WRS4-74-1442SS	76 lbs	WRSAD4-74-1442SS	71 lbs	WRS4-86-1442SS	80 lbs	WRSAD4-86-1442SS	73 lbs	
14" x 48"	WRS4-74-1448SS	84 lbs	WRSAD4-74-1448SS	79 lbs	WRS4-86-1448SS	88 lbs	WRSAD4-86-1448SS	81 lbs	
14" x 54"	WRS4-74-1454SS	96 lbs	WRSAD4-74-1454SS	91 lbs	WRS4-86-1454SS	100 lbs	WRSAD4-86-1454SS	93 lbs	
14" x 60"	WRS4-74-1460SS	104 lbs	WRSAD4-74-1460SS	99 lbs	WRS4-86-1460SS	108 lbs	WRSAD4-86-1460SS	101 lbs	
14" x 72"	WRS4-74-1472SS	120 lbs	WRSAD4-74-1472SS	115 lbs	WRS4-86-1472SS	124 lbs	WRSAD4-86-1472SS	117 lbs	
18" x 24"	WRS4-74-1824SS	60 lbs	WRSAD4-74-1824SS	55 lbs	WRS4-86-1824SS	64 lbs	WRSAD4-86-1824SS	57 lbs	
18" x 30"	WRS4-74-1830SS	72 lbs	WRSAD4-74-1830SS	67 lbs	WRS4-86-1830SS	76 lbs	WRSAD4-86-1830SS	69 lbs	
18" x 36"	WRS4-74-1836SS	80 lbs	WRSAD4-74-1836SS	75 lbs	WRS4-86-1836SS	84 lbs	WRSAD4-86-1836SS	77 lbs	
18" x 42"	WRS4-74-1842SS	88 lbs	WRSAD4-74-1842SS	83 lbs	WRS4-86-1842SS	92 lbs	WRSAD4-86-1842SS	85 lbs	
18" x 48"	WRS4-74-1848SS	96 lbs	WRSAD4-74-1848SS	91 lbs	WRS4-86-1848SS	100 lbs	WRSAD4-86-1848SS	93 lbs	
18" x 54"	WRS4-74-1854SS	104 lbs	WRSAD4-74-1854SS	99 lbs	WRS4-86-1854SS	108 lbs	WRSAD4-86-1854SS	101 lbs	
18" x 60"	WRS4-74-1860SS	112 lbs	WRSAD4-74-1860SS	107 lbs	WRS4-86-1860SS	116 lbs	WRSAD4-86-1860SS	109 lbs	
18" x 72"	WRS4-74-1872SS	124 lbs	WRSAD4-74-1872SS	119 lbs	WRS4-86-1872SS	128 lbs	WRSAD4-86-1872SS	121 lbs	
21" x 24"	WRS4-74-2124SS	68 lbs	WRSAD4-74-2124SS	63 lbs	WRS4-86-2124SS	72 lbs	WRSAD4-86-2124SS	65 lbs	
21" x 30"	WRS4-74-2130SS	76 lbs	WRSAD4-74-2130SS	71 lbs	WRS4-86-2130SS	80 lbs	WRSAD4-86-2130SS	73 lbs	
21" x 36"	WRS4-74-2136SS	88 lbs	WRSAD4-74-2136SS	83 lbs	WRS4-86-2136SS	92 lbs	WRSAD4-86-2136SS	85 lbs	
21" x 42"	WRS4-74-2142SS	100 lbs	WRSAD4-74-2142SS	95 lbs	WRS4-86-2142SS	104 lbs	WRSAD4-86-2142SS	97 lbs	
21" x 48"	WRS4-74-2148SS	108 lbs	WRSAD4-74-2148SS	103 lbs	WRS4-86-2148SS	112 lbs	WRSAD4-86-2148SS	105 lbs	
21" x 54"	WRS4-74-2154SS	116 lbs	WRSAD4-74-2154SS	111 lbs	WRS4-86-2154SS	120 lbs	WRSAD4-86-2154SS	113 lbs	
21" x 60"	WRS4-74-2160SS	128 lbs	WRSAD4-74-2160SS	123 lbs	WRS4-86-2160SS	132 lbs	WRSAD4-86-2160SS	125 lbs	
21" x 72"	WRS4-74-2172SS	136 lbs	WRSAD4-74-2172SS	131 lbs	WRS4-86-2172SS	140 lbs	WRSAD4-86-2172SS	133 lbs	
24" x 24"	WRS4-74-2424SS	76 lbs	WRSAD4-74-2424SS	71 lbs	WRS4-86-2424SS	80 lbs	WRSAD4-86-2424SS	73 lbs	
24" x 30"	WRS4-74-2430SS	84 lbs	WRSAD4-74-2430SS	79 lbs	WRS4-86-2430SS	88 lbs	WRSAD4-86-2430SS	81 lbs	
24" x 36"	WRS4-74-2436SS	92 lbs	WRSAD4-74-2436SS	87 lbs	WRS4-86-2436SS	96 lbs	WRSAD4-86-2436SS	89 lbs	
24" x 42"	WRS4-74-2442SS	104 lbs	WRSAD4-74-2442SS	99 lbs	WRS4-86-2442SS	108 lbs	WRSAD4-86-2442SS	101 lbs	
24" x 48"	WRS4-74-2448SS	112 lbs	WRSAD4-74-2448SS	107 lbs	WRS4-86-2448SS	116 lbs	WRSAD4-86-2448SS	109 lbs	
24" x 54"	WRS4-74-2454SS	128 lbs	WRSAD4-74-2454SS	123 lbs	WRS4-86-2454SS	132 lbs	WRSAD4-86-2454SS	125 lbs	
24" x 60"	WRS4-74-2460SS	140 lbs	WRSAD4-74-2460SS	135 lbs	WRS4-86-2460SS	144 lbs	WRSAD4-86-2460SS	137 lbs	
24" x 72"	WRS4-74-2472SS	152 lbs	WRSAD4-74-2472SS	147 lbs	WRS4-86-2472SS	156 lbs	WRSAD4-86-2472SS	149 lbs	

Shelving units include 4 posts and 4 shelves. Add-On units include 2 posts, 4 shelves and 8 shelf clamps.

SHELF W" x L"	54"H STAINLESS SOLID SHELVING 5 SHELVES				63"H STAINLESS SOLID SHELVING 5 SHELVES			
	STARTER KIT		ADD-ON KIT		STARTER KIT		ADD-ON KIT	
	MODEL NO.	SHIP WGT	MODEL NO.	SHIP WGT	MODEL NO.	SHIP WGT	MODEL NO.	SHIP WGT
14" x 36"	WRS5-54-1436SS	82 lbs	WRSAD5-54-1436SS	79 lbs	WRS5-63-1436SS	86 lbs	WRSAD5-63-1436SS	81 lbs
14" x 42"	WRS5-54-1442SS	87 lbs	WRSAD5-54-1442SS	84 lbs	WRS5-63-1442SS	91 lbs	WRSAD5-63-1442SS	86 lbs
14" x 48"	WRS5-54-1448SS	97 lbs	WRSAD5-54-1448SS	94 lbs	WRS5-63-1448SS	101 lbs	WRSAD5-63-1448SS	96 lbs
14" x 54"	WRS5-54-1454SS	112 lbs	WRSAD5-54-1454SS	109 lbs	WRS5-63-1454SS	116 lbs	WRSAD5-63-1454SS	111 lbs
14" x 60"	WRS5-54-1460SS	122 lbs	WRSAD5-54-1460SS	119 lbs	WRS5-63-1460SS	126 lbs	WRSAD5-63-1460SS	121 lbs
14" x 72"	WRS5-54-1472SS	142 lbs	WRSAD5-54-1472SS	139 lbs	WRS5-63-1472SS	146 lbs	WRSAD5-63-1472SS	141 lbs
18" x 24"	WRS5-54-1824SS	67 lbs	WRSAD5-54-1824SS	64 lbs	WRS5-63-1824SS	71 lbs	WRSAD5-63-1824SS	66 lbs
18" x 30"	WRS5-54-1830SS	82 lbs	WRSAD5-54-1830SS	79 lbs	WRS5-63-1830SS	86 lbs	WRSAD5-63-1830SS	81 lbs
18" x 36"	WRS5-54-1836SS	92 lbs	WRSAD5-54-1836SS	89 lbs	WRS5-63-1836SS	96 lbs	WRSAD5-63-1836SS	91 lbs
18" x 42"	WRS5-54-1842SS	102 lbs	WRSAD5-54-1842SS	99 lbs	WRS5-63-1842SS	106 lbs	WRSAD5-63-1842SS	101 lbs
18" x 48"	WRS5-54-1848SS	112 lbs	WRSAD5-54-1848SS	109 lbs	WRS5-63-1848SS	116 lbs	WRSAD5-63-1848SS	111 lbs
18" x 54"	WRS5-54-1854SS	122 lbs	WRSAD5-54-1854SS	119 lbs	WRS5-63-1854SS	126 lbs	WRSAD5-63-1854SS	121 lbs
18" x 60"	WRS5-54-1860SS	132 lbs	WRSAD5-54-1860SS	129 lbs	WRS5-63-1860SS	136 lbs	WRSAD5-63-1860SS	131 lbs
18" x 72"	WRS5-54-1872SS	147 lbs	WRSAD5-54-1872SS	144 lbs	WRS5-63-1872SS	151 lbs	WRSAD5-63-1872SS	146 lbs
21" x 24"	WRS5-54-2124SS	77 lbs	WRSAD5-54-2124SS	74 lbs	WRS5-63-2124SS	81 lbs	WRSAD5-63-2124SS	76 lbs
21" x 30"	WRS5-54-2130SS	87 lbs	WRSAD5-54-2130SS	84 lbs	WRS5-63-2130SS	91 lbs	WRSAD5-63-2130SS	86 lbs
21" x 36"	WRS5-54-2136SS	102 lbs	WRSAD5-54-2136SS	99 lbs	WRS5-63-2136SS	106 lbs	WRSAD5-63-2136SS	101 lbs
21" x 42"	WRS5-54-2142SS	117 lbs	WRSAD5-54-2142SS	114 lbs	WRS5-63-2142SS	121 lbs	WRSAD5-63-2142SS	116 lbs
21" x 48"	WRS5-54-2148SS	127 lbs	WRSAD5-54-2148SS	124 lbs	WRS5-63-2148SS	131 lbs	WRSAD5-63-2148SS	126 lbs
21" x 54"	WRS5-54-2154SS	137 lbs	WRSAD5-54-2154SS	134 lbs	WRS5-63-2154SS	141 lbs	WRSAD5-63-2154SS	136 lbs
21" x 60"	WRS5-54-2160SS	152 lbs	WRSAD5-54-2160SS	149 lbs	WRS5-63-2160SS	156 lbs	WRSAD5-63-2160SS	151 lbs
21" x 72"	WRS5-54-2172SS	162 lbs	WRSAD5-54-2172SS	159 lbs	WRS5-63-2172SS	166 lbs	WRSAD5-63-2172SS	161 lbs
24" x 24"	WRS5-54-2424SS	87 lbs	WRSAD5-54-2424SS	84 lbs	WRS5-63-2424SS	91 lbs	WRSAD5-63-2424SS	86 lbs
24" x 30"	WRS5-54-2430SS	97 lbs	WRSAD5-54-2430SS	94 lbs	WRS5-63-2430SS	101 lbs	WRSAD5-63-2430SS	96 lbs
24" x 36"	WRS5-54-2436SS	107 lbs	WRSAD5-54-2436SS	104 lbs	WRS5-63-2436SS	111 lbs	WRSAD5-63-2436SS	106 lbs
24" x 42"	WRS5-54-2442SS	122 lbs	WRSAD5-54-2442SS	119 lbs	WRS5-63-2442SS	126 lbs	WRSAD5-63-2442SS	121 lbs
24" x 48"	WRS5-54-2448SS	132 lbs	WRSAD5-54-2448SS	129 lbs	WRS5-63-2448SS	136 lbs	WRSAD5-63-2448SS	131 lbs
24" x 54"	WRS5-54-2454SS	152 lbs	WRSAD5-54-2454SS	149 lbs	WRS5-63-2454SS	156 lbs	WRSAD5-63-2454SS	151 lbs
24" x 60"	WRS5-54-2460SS	167 lbs	WRSAD5-54-2460SS	164 lbs	WRS5-63-2460SS	171 lbs	WRSAD5-63-2460SS	166 lbs
24" x 72"	WRS5-54-2472SS	182 lbs	WRSAD5-54-2472SS	179 lbs	WRS5-63-2472SS	186 lbs	WRSAD5-63-2472SS	181 lbs

Shelving units include 4 posts and 5 shelves. Add-On units include 2 posts, 5 shelves and 10 shelf clamps.

18 Gauge 304 Stainless Steel

SHELF W" x L"	74"H STAINLESS SOLID SHELVING 5 SHELVES				86"H STAINLESS SOLID SHELVING 5 SHELVES			
	STARTER KIT		ADD-ON KIT		STARTER KIT		ADD-ON KIT	
	MODEL NO.	SHIP WGT	MODEL NO.	SHIP WGT	MODEL NO.	SHIP WGT	MODEL NO.	SHIP WGT
14" x 36"	WRS5-74-1436SS	86 lbs	WRSAD5-74-1436SS	81 lbs	WRS5-86-1436SS	90 lbs	WRSAD5-86-1436SS	83 lbs
14" x 42"	WRS5-74-1442SS	91 lbs	WRSAD5-74-1442SS	86 lbs	WRS5-86-1442SS	95 lbs	WRSAD5-86-1442SS	88 lbs
14" x 48"	WRS5-74-1448SS	101 lbs	WRSAD5-74-1448SS	91 lbs	WRS5-86-1448SS	105 lbs	WRSAD5-86-1448SS	98 lbs
14" x 54"	WRS5-74-1454SS	116 lbs	WRSAD5-74-1454SS	111 lbs	WRS5-86-1454SS	120 lbs	WRSAD5-86-1454SS	113 lbs
14" x 60"	WRS5-74-1460SS	126 lbs	WRSAD5-74-1460SS	121 lbs	WRS5-86-1460SS	130 lbs	WRSAD5-86-1460SS	123 lbs
14" x 72"	WRS5-74-1472SS	146 lbs	WRSAD5-74-1472SS	141 lbs	WRS5-86-1472SS	150 lbs	WRSAD5-86-1472SS	143 lbs
18" x 24"	WRS5-74-1824SS	71 lbs	WRSAD5-74-1824SS	66 lbs	WRS5-86-1824SS	75 lbs	WRSAD5-86-1824SS	68 lbs
18" x 30"	WRS5-74-1830SS	86 lbs	WRSAD5-74-1830SS	81 lbs	WRS5-86-1830SS	90 lbs	WRSAD5-86-1830SS	83 lbs
18" x 36"	WRS5-74-1836SS	96 lbs	WRSAD5-74-1836SS	91 lbs	WRS5-86-1836SS	100 lbs	WRSAD5-86-1836SS	93 lbs
18" x 42"	WRS5-74-1842SS	106 lbs	WRSAD5-74-1842SS	101 lbs	WRS5-86-1842SS	110 lbs	WRSAD5-86-1842SS	103 lbs
18" x 48"	WRS5-74-1848SS	116 lbs	WRSAD5-74-1848SS	111 lbs	WRS5-86-1848SS	120 lbs	WRSAD5-86-1848SS	113 lbs
18" x 54"	WRS5-74-1854SS	126 lbs	WRSAD5-74-1854SS	121 lbs	WRS5-86-1854SS	130 lbs	WRSAD5-86-1854SS	123 lbs
18" x 60"	WRS5-74-1860SS	136 lbs	WRSAD5-74-1860SS	131 lbs	WRS5-86-1860SS	140 lbs	WRSAD5-86-1860SS	133 lbs
18" x 72"	WRS5-74-1872SS	151 lbs	WRSAD5-74-1872SS	146 lbs	WRS5-86-1872SS	155 lbs	WRSAD5-86-1872SS	148 lbs
21" x 24"	WRS5-74-2124SS	81 lbs	WRSAD5-74-2124SS	76 lbs	WRS5-86-2124SS	85 lbs	WRSAD5-86-2124SS	78 lbs
21" x 30"	WRS5-74-2130SS	91 lbs	WRSAD5-74-2130SS	86 lbs	WRS5-86-2130SS	95 lbs	WRSAD5-86-2130SS	88 lbs
21" x 36"	WRS5-74-2136SS	106 lbs	WRSAD5-74-2136SS	101 lbs	WRS5-86-2136SS	110 lbs	WRSAD5-86-2136SS	103 lbs
21" x 42"	WRS5-74-2142SS	121 lbs	WRSAD5-74-2142SS	116 lbs	WRS5-86-2142SS	125 lbs	WRSAD5-86-2142SS	118 lbs
21" x 48"	WRS5-74-2148SS	131 lbs	WRSAD5-74-2148SS	126 lbs	WRS5-86-2148SS	135 lbs	WRSAD5-86-2148SS	128 lbs
21" x 54"	WRS5-74-2154SS	141 lbs	WRSAD5-74-2154SS	136 lbs	WRS5-86-2154SS	145 lbs	WRSAD5-86-2154SS	138 lbs
21" x 60"	WRS5-74-2160SS	156 lbs	WRSAD5-74-2160SS	151 lbs	WRS5-86-2160SS	160 lbs	WRSAD5-86-2160SS	153 lbs
21" x 72"	WRS5-74-2172SS	166 lbs	WRSAD5-74-2172SS	161 lbs	WRS5-86-2172SS	170 lbs	WRSAD5-86-2172SS	163 lbs
24" x 24"	WRS5-74-2424SS	91 lbs	WRSAD5-74-2424SS	86 lbs	WRS5-86-2424SS	95 lbs	WRSAD5-86-2424SS	88 lbs
24" x 30"	WRS5-74-2430SS	101 lbs	WRSAD5-74-2430SS	96 lbs	WRS5-86-2430SS	105 lbs	WRSAD5-86-2430SS	98 lbs
24" x 36"	WRS5-74-2436SS	111 lbs	WRSAD5-74-2436SS	106 lbs	WRS5-86-2436SS	115 lbs	WRSAD5-86-2436SS	108 lbs
24" x 42"	WRS5-74-2442SS	126 lbs	WRSAD5-74-2442SS	121 lbs	WRS5-86-2442SS	130 lbs	WRSAD5-86-2442SS	123 lbs
24" x 48"	WRS5-74-2448SS	136 lbs	WRSAD5-74-2448SS	131 lbs	WRS5-86-2448SS	140 lbs	WRSAD5-86-2448SS	133 lbs
24" x 54"	WRS5-74-2454SS	156 lbs	WRSAD5-74-2454SS	151 lbs	WRS5-86-2454SS	160 lbs	WRSAD5-86-2454SS	153 lbs
24" x 60"	WRS5-74-2460SS	171 lbs	WRSAD5-74-2460SS	166 lbs	WRS5-86-2460SS	175 lbs	WRSAD5-86-2460SS	168 lbs
24" x 72"	WRS5-74-2472SS	186 lbs	WRSAD5-74-2472SS	181 lbs	WRS5-86-2472SS	205 lbs	WRSAD5-86-2472SS	198 lbs

Shelving units include 4 posts and 5 shelves. Add-On units include 2 posts, 5 shelves and 10 shelf clamps.

5 Shelf Starter Kits

Solid shelves are a solution where dirt, dust and spills are a potential issue. The solid flat surface allows for storage from small to large items and the marine edge perimeter prevents spillage. The double hemmed 18 gauge 304 stainless steel gives the solid shelf excellent strength characteristics. All solid shelf units consist of 5 shelves and 4 posts. Mobilize starter kit shelving unit using optional mobile kit **WR-00H**. See pg. 79. **Finish:** Stainless Steel



MOBILIZE YOUR SHELVING

DB - Donut Bumper
Non-marking donut bumper used to protect walls and help cushion impact.

WR-00H (Mobile Kit)*
Set of four swivel polyurethane 5" x 1-1/4" casters, two with brakes. Can be used with all units shown. 1,200 lb. load capacity. *Mobile kits recommended only for shelves 18" and wider.



QSMC Shelf Clamp
Shelf Clamp eliminates 2 post per shelving section. Two QSMC clamps are required per shelf. **Finish:** Aluminum



ADD-ON KIT

5 Shelf Add-On Kits

Additional Add-On kit allows you to expand your Starter kit by sharing a set of posts. Configuration options include straight line, back to back and right angles (*L-Shape*). Add-On units consist of 5 shelves, 2 posts and 10 shelf clamps. Additional shelves may be purchased separately. See chart on pg. 39. Units with Add-On kit cannot be made mobile. **Finish:** Stainless Steel

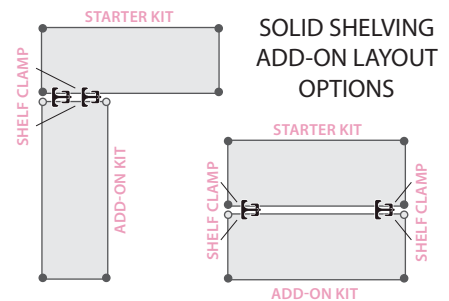
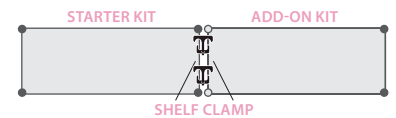



4 Shelf Starter Kits

Solid shelves are a solution where dirt, dust and spills are a potential issue. The solid flat surface allows for storage from small to large items and the marine edge perimeter prevents spillage. The double hemmed 18 gauge galvanized steel gives the solid shelf excellent strength characteristics. All solid shelf units consist of 4 shelves and 4 posts. Mobilize starter kit shelving unit using optional mobile kit **WR-00H**. See pg. 79. **Finish:** Galvanized Steel



MOBILIZE YOUR SHELVING

DB - Donut Bumper

Non-marking donut bumper used to protect walls and help cushion impact.

WR-00H (Mobile Kit)*

Set of four swivel polyurethane 5" x 1-1/4" casters, two with brakes. Can be used with all units shown. 1,200 lb. load capacity. *Mobile kits recommended only for shelves 18" and wider.



STARTER KIT



QSMC Shelf Clamp
Shelf Clamp eliminates 2 post per shelving section. Two QSMC clamps are required per shelf. **Finish:** Aluminum

4 Shelf Add-On Kits

Additional Add-On kit allows you to expand your Starter kit by sharing a set of posts. Configuration options include straight line, back to back and right angles (*L-Shape*). Add-On units consist of 4 shelves, 2 posts and 8 shelf clamps. Additional shelves may be purchased separately. See chart on pg. 39. Units with Add-On kit cannot be made mobile. **Finish:** Galvanized Steel

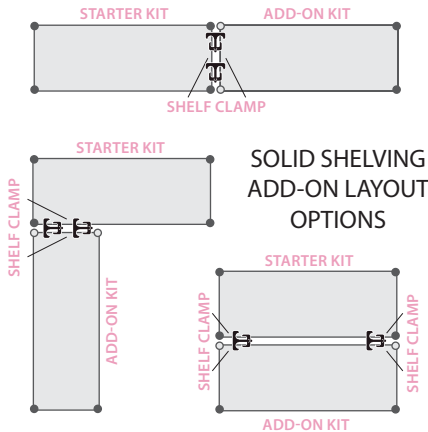

54"H GALVANIZED SOLID SHELVING 4 SHELVES					63"H GALVANIZED SOLID SHELVING 4 SHELVES			
STARTER KIT		ADD-ON KIT			STARTER KIT		ADD-ON KIT	
SHELF W" x L"	MODEL NO.	SHIP WGT	MODEL NO.	SHIP WGT	MODEL NO.	SHIP WGT	MODEL NO.	SHIP WGT
14" x 36"	WR54-1436SG	68 lbs	AD54-1436SG	65 lbs	WR63-1436SG	72 lbs	AD63-1436SG	67 lbs
14" x 42"	WR54-1442SG	72 lbs	AD54-1442SG	69 lbs	WR63-1442SG	76 lbs	AD63-1442SG	71 lbs
14" x 48"	WR54-1448SG	80 lbs	AD54-1448SG	77 lbs	WR63-1448SG	84 lbs	AD63-1448SG	79 lbs
14" x 54"	WR54-1454SG	92 lbs	AD54-1454SG	89 lbs	WR63-1454SG	96 lbs	AD63-1454SG	91 lbs
14" x 60"	WR54-1460SG	100 lbs	AD54-1460SG	97 lbs	WR63-1460SG	104 lbs	AD63-1460SG	99 lbs
14" x 72"	WR54-1472SG	116 lbs	AD54-1472SG	113 lbs	WR63-1472SG	120 lbs	AD63-1472SG	115 lbs
18" x 24"	WR54-1824SG	56 lbs	AD54-1824SG	53 lbs	WR63-1824SG	60 lbs	AD63-1824SG	55 lbs
18" x 30"	WR54-1830SG	68 lbs	AD54-1830SG	65 lbs	WR63-1830SG	72 lbs	AD63-1830SG	67 lbs
18" x 36"	WR54-1836SG	76 lbs	AD54-1836SG	73 lbs	WR63-1836SG	80 lbs	AD63-1836SG	75 lbs
18" x 42"	WR54-1842SG	84 lbs	AD54-1842SG	81 lbs	WR63-1842SG	88 lbs	AD63-1842SG	83 lbs
18" x 48"	WR54-1848SG	92 lbs	AD54-1848SG	89 lbs	WR63-1848SG	96 lbs	AD63-1848SG	91 lbs
18" x 54"	WR54-1854SG	100 lbs	AD54-1854SG	97 lbs	WR63-1854SG	104 lbs	AD63-1854SG	99 lbs
18" x 60"	WR54-1860SG	108 lbs	AD54-1860SG	105 lbs	WR63-1860SG	112 lbs	AD63-1860SG	107 lbs
18" x 72"	WR54-1872SG	120 lbs	AD54-1872SG	117 lbs	WR63-1872SG	124 lbs	AD63-1872SG	119 lbs
21" x 24"	WR54-2124SG	64 lbs	AD54-2124SG	61 lbs	WR63-2124SG	68 lbs	AD63-2124SG	63 lbs
21" x 30"	WR54-2130SG	72 lbs	AD54-2130SG	69 lbs	WR63-2130SG	76 lbs	AD63-2130SG	71 lbs
21" x 36"	WR54-2136SG	84 lbs	AD54-2136SG	81 lbs	WR63-2136SG	88 lbs	AD63-2136SG	83 lbs
21" x 42"	WR54-2142SG	96 lbs	AD54-2142SG	93 lbs	WR63-2142SG	100 lbs	AD63-2142SG	95 lbs
21" x 48"	WR54-2148SG	104 lbs	AD54-2148SG	101 lbs	WR63-2148SG	108 lbs	AD63-2148SG	103 lbs
21" x 54"	WR54-2154SG	112 lbs	AD54-2154SG	109 lbs	WR63-2154SG	116 lbs	AD63-2154SG	111 lbs
21" x 60"	WR54-2160SG	124 lbs	AD54-2160SG	121 lbs	WR63-2160SG	128 lbs	AD63-2160SG	123 lbs
21" x 72"	WR54-2172SG	132 lbs	AD54-2172SG	129 lbs	WR63-2172SG	136 lbs	AD63-2172SG	131 lbs
24" x 24"	WR54-2424SG	72 lbs	AD54-2424SG	69 lbs	WR63-2424SG	76 lbs	AD63-2424SG	71 lbs
24" x 30"	WR54-2430SG	80 lbs	AD54-2430SG	77 lbs	WR63-2430SG	84 lbs	AD63-2430SG	79 lbs
24" x 36"	WR54-2436SG	88 lbs	AD54-2436SG	85 lbs	WR63-2436SG	92 lbs	AD63-2436SG	87 lbs
24" x 42"	WR54-2442SG	100 lbs	AD54-2442SG	97 lbs	WR63-2442SG	104 lbs	AD63-2442SG	99 lbs
24" x 48"	WR54-2448SG	108 lbs	AD54-2448SG	105 lbs	WR63-2448SG	112 lbs	AD63-2448SG	107 lbs
24" x 54"	WR54-2454SG	124 lbs	AD54-2454SG	121 lbs	WR63-2454SG	128 lbs	AD63-2454SG	123 lbs
24" x 60"	WR54-2460SG	136 lbs	AD54-2460SG	133 lbs	WR63-2460SG	140 lbs	AD63-2460SG	135 lbs
24" x 72"	WR54-2472SG	148 lbs	AD54-2472SG	145 lbs	WR63-2472SG	152 lbs	AD63-2472SG	147 lbs

Shelving units include 4 posts and 4 shelves. Add-On units include 2 posts, 4 shelves and 8 shelf clamps.

18 Gauge Galvanized Steel

74"H GALVANIZED SOLID SHELVING 4 SHELVES					86"H GALVANIZED SOLID SHELVING 4 SHELVES			
STARTER KIT		ADD-ON KIT			STARTER KIT		ADD-ON KIT	
SHELF W" x L"	MODEL NO.	SHIP WGT	MODEL NO.	SHIP WGT	MODEL NO.	SHIP WGT	MODEL NO.	SHIP WGT
14" x 36"	WR74-1436SG	72 lbs	AD74-1436SG	67 lbs	WR86-1436SG	76 lbs	AD86-1436SG	69 lbs
14" x 42"	WR74-1442SG	76 lbs	AD74-1442SG	71 lbs	WR86-1442SG	80 lbs	AD86-1442SG	73 lbs
14" x 48"	WR74-1448SG	84 lbs	AD74-1448SG	79 lbs	WR86-1448SG	88 lbs	AD86-1448SG	81 lbs
14" x 54"	WR74-1454SG	96 lbs	AD74-1454SG	91 lbs	WR86-1454SG	100 lbs	AD86-1454SG	93 lbs
14" x 60"	WR74-1460SG	104 lbs	AD74-1460SG	99 lbs	WR86-1460SG	108 lbs	AD86-1460SG	101 lbs
14" x 72"	WR74-1472SG	120 lbs	AD74-1472SG	115 lbs	WR86-1472SG	124 lbs	AD86-1472SG	117 lbs
18" x 24"	WR74-1824SG	60 lbs	AD74-1824SG	55 lbs	WR86-1824SG	64 lbs	AD86-1824SG	57 lbs
18" x 30"	WR74-1830SG	72 lbs	AD74-1830SG	67 lbs	WR86-1830SG	76 lbs	AD86-1830SG	69 lbs
18" x 36"	WR74-1836SG	80 lbs	AD74-1836SG	75 lbs	WR86-1836SG	84 lbs	AD86-1836SG	77 lbs
18" x 42"	WR74-1842SG	88 lbs	AD74-1842SG	83 lbs	WR86-1842SG	92 lbs	AD86-1842SG	85 lbs
18" x 48"	WR74-1848SG	96 lbs	AD74-1848SG	91 lbs	WR86-1848SG	100 lbs	AD86-1848SG	93 lbs
18" x 54"	WR74-1854SG	104 lbs	AD74-1854SG	99 lbs	WR86-1854SG	108 lbs	AD86-1854SG	101 lbs
18" x 60"	WR74-1860SG	112 lbs	AD74-1860SG	107 lbs	WR86-1860SG	116 lbs	AD86-1860SG	109 lbs
18" x 72"	WR74-1872SG	124 lbs	AD74-1872SG	119 lbs	WR86-1872SG	128 lbs	AD86-1872SG	121 lbs
21" x 24"	WR74-2124SG	68 lbs	AD74-2124SG	63 lbs	WR86-2124SG	72 lbs	AD86-2124SG	65 lbs
21" x 30"	WR74-2130SG	76 lbs	AD74-2130SG	71 lbs	WR86-2130SG	80 lbs	AD86-2130SG	73 lbs
21" x 36"	WR74-2136SG	88 lbs	AD74-2136SG	83 lbs	WR86-2136SG	92 lbs	AD86-2136SG	85 lbs
21" x 42"	WR74-2142SG	100 lbs	AD74-2142SG	95 lbs	WR86-2142SG	104 lbs	AD86-2142SG	97 lbs
21" x 48"	WR74-2148SG	108 lbs	AD74-2148SG	103 lbs	WR86-2148SG	112 lbs	AD86-2148SG	105 lbs
21" x 54"	WR74-2154SG	116 lbs	AD74-2154SG	111 lbs	WR86-2154SG	120 lbs	AD86-2154SG	113 lbs
21" x 60"	WR74-2160SG	128 lbs	AD74-2160SG	123 lbs	WR86-2160SG	132 lbs	AD86-2160SG	125 lbs
21" x 72"	WR74-2172SG	136 lbs	AD74-2172SG	131 lbs	WR86-2172SG	140 lbs	AD86-2172SG	133 lbs
24" x 24"	WR74-2424SG	76 lbs	AD74-2424SG	71 lbs	WR86-2424SG	80 lbs	AD86-2424SG	73 lbs
24" x 30"	WR74-2430SG	84 lbs	AD74-2430SG	79 lbs	WR86-2430SG	88 lbs	AD86-2430SG	81 lbs
24" x 36"	WR74-2436SG	92 lbs	AD74-2436SG	87 lbs	WR86-2436SG	96 lbs	AD86-2436SG	89 lbs
24" x 42"	WR74-2442SG	104 lbs	AD74-2442SG	99 lbs	WR86-2442SG	108 lbs	AD86-2442SG	101 lbs
24" x 48"	WR74-2448SG	112 lbs	AD74-2448SG	107 lbs	WR86-2448SG	116 lbs	AD86-2448SG	109 lbs
24" x 54"	WR74-2454SG	128 lbs	AD74-2454SG	123 lbs	WR86-2454SG	132 lbs	AD86-2454SG	125 lbs
24" x 60"	WR74-2460SG	140 lbs	AD74-2460SG	135 lbs	WR86-2460SG	144 lbs	AD86-2460SG	137 lbs
24" x 72"	WR74-2472SG	152 lbs	AD74-2472SG	147 lbs	WR86-2472SG	156 lbs	AD86-2472SG	149 lbs

Shelving units include 4 posts and 4 shelves. Add-On units include 2 posts, 4 shelves and 8 shelf clamps.



54"H GALVANIZED SOLID SHELVING 5 SHELVES					63"H GALVANIZED SOLID SHELVING 5 SHELVES			
STARTER KIT			ADD-ON KIT		STARTER KIT		ADD-ON KIT	
SHELF W" x L"	MODEL NO.	SHIP WGT	MODEL NO.	SHIP WGT	MODEL NO.	SHIP WGT	MODEL NO.	SHIP WGT
14" x 36"	WR54-1436SG-5	82 lbs	AD54-1436SG-5	79 lbs	WR63-1436SG-5	86 lbs	AD63-1436SG-5	81 lbs
14" x 42"	WR54-1442SG-5	87 lbs	AD54-1442SG-5	84 lbs	WR63-1442SG-5	91 lbs	AD63-1442SG-5	86 lbs
14" x 48"	WR54-1448SG-5	97 lbs	AD54-1448SG-5	94 lbs	WR63-1448SG-5	101 lbs	AD63-1448SG-5	96 lbs
14" x 54"	WR54-1454SG-5	112 lbs	AD54-1454SG-5	109 lbs	WR63-1454SG-5	116 lbs	AD63-1454SG-5	111 lbs
14" x 60"	WR54-1460SG-5	122 lbs	AD54-1460SG-5	119 lbs	WR63-1460SG-5	126 lbs	AD63-1460SG-5	121 lbs
14" x 72"	WR54-1472SG-5	142 lbs	AD54-1472SG-5	139 lbs	WR63-1472SG-5	146 lbs	AD63-1472SG-5	141 lbs
18" x 24"	WR54-1824SG-5	67 lbs	AD54-1824SG-5	64 lbs	WR63-1824SG-5	71 lbs	AD63-1824SG-5	66 lbs
18" x 30"	WR54-1830SG-5	82 lbs	AD54-1830SG-5	79 lbs	WR63-1830SG-5	86 lbs	AD63-1830SG-5	81 lbs
18" x 36"	WR54-1836SG-5	92 lbs	AD54-1836SG-5	89 lbs	WR63-1836SG-5	96 lbs	AD63-1836SG-5	91 lbs
18" x 42"	WR54-1842SG-5	102 lbs	AD54-1842SG-5	99 lbs	WR63-1842SG-5	106 lbs	AD63-1842SG-5	101 lbs
18" x 48"	WR54-1848SG-5	112 lbs	AD54-1848SG-5	109 lbs	WR63-1848SG-5	116 lbs	AD63-1848SG-5	111 lbs
18" x 54"	WR54-1854SG-5	122 lbs	AD54-1854SG-5	119 lbs	WR63-1854SG-5	126 lbs	AD63-1854SG-5	121 lbs
18" x 60"	WR54-1860SG-5	132 lbs	AD54-1860SG-5	129 lbs	WR63-1860SG-5	136 lbs	AD63-1860SG-5	131 lbs
18" x 72"	WR54-1872SG-5	147 lbs	AD54-1872SG-5	144 lbs	WR63-1872SG-5	151 lbs	AD63-1872SG-5	146 lbs
21" x 24"	WR54-2124SG-5	77 lbs	AD54-2124SG-5	74 lbs	WR63-2124SG-5	81 lbs	AD63-2124SG-5	76 lbs
21" x 30"	WR54-2130SG-5	87 lbs	AD54-2130SG-5	84 lbs	WR63-2130SG-5	91 lbs	AD63-2130SG-5	86 lbs
21" x 36"	WR54-2136SG-5	102 lbs	AD54-2136SG-5	99 lbs	WR63-2136SG-5	106 lbs	AD63-2136SG-5	101 lbs
21" x 42"	WR54-2142SG-5	117 lbs	AD54-2142SG-5	114 lbs	WR63-2142SG-5	121 lbs	AD63-2142SG-5	116 lbs
21" x 48"	WR54-2148SG-5	127 lbs	AD54-2148SG-5	124 lbs	WR63-2148SG-5	131 lbs	AD63-2148SG-5	126 lbs
21" x 54"	WR54-2154SG-5	137 lbs	AD54-2154SG-5	134 lbs	WR63-2154SG-5	141 lbs	AD63-2154SG-5	136 lbs
21" x 60"	WR54-2160SG-5	152 lbs	AD54-2160SG-5	149 lbs	WR63-2160SG-5	156 lbs	AD63-2160SG-5	151 lbs
21" x 72"	WR54-2172SG-5	162 lbs	AD54-2172SG-5	159 lbs	WR63-2172SG-5	166 lbs	AD63-2172SG-5	161 lbs
24" x 24"	WR54-2424SG-5	87 lbs	AD54-2424SG-5	84 lbs	WR63-2424SG-5	91 lbs	AD63-2424SG-5	86 lbs
24" x 30"	WR54-2430SG-5	97 lbs	AD54-2430SG-5	94 lbs	WR63-2430SG-5	101 lbs	AD63-2430SG-5	96 lbs
24" x 36"	WR54-2436SG-5	107 lbs	AD54-2436SG-5	104 lbs	WR63-2436SG-5	111 lbs	AD63-2436SG-5	106 lbs
24" x 42"	WR54-2442SG-5	122 lbs	AD54-2442SG-5	119 lbs	WR63-2442SG-5	126 lbs	AD63-2442SG-5	121 lbs
24" x 48"	WR54-2448SG-5	132 lbs	AD54-2448SG-5	129 lbs	WR63-2448SG-5	136 lbs	AD63-2448SG-5	131 lbs
24" x 54"	WR54-2454SG-5	152 lbs	AD54-2454SG-5	149 lbs	WR63-2454SG-5	156 lbs	AD63-2454SG-5	151 lbs
24" x 60"	WR54-2460SG-5	167 lbs	AD54-2460SG-5	164 lbs	WR63-2460SG-5	171 lbs	AD63-2460SG-5	166 lbs
24" x 72"	WR54-2472SG-5	182 lbs	AD54-2472SG-5	179 lbs	WR63-2472SG-5	186 lbs	AD63-2472SG-5	181 lbs

Shelving units include 4 posts and 5 shelves. Add-On units include 2 posts, 5 shelves and 10 shelf clamps.

18 Gauge Galvanized Steel

74"H GALVANIZED SOLID SHELVING 5 SHELVES					86"H GALVANIZED SOLID SHELVING 5 SHELVES			
STARTER KIT			ADD-ON KIT		STARTER KIT		ADD-ON KIT	
SHELF W" x L"	MODEL NO.	SHIP WGT	MODEL NO.	SHIP WGT	MODEL NO.	SHIP WGT	MODEL NO.	SHIP WGT
14" x 36"	WR74-1436SG-5	86 lbs	AD74-1436SG-5	81 lbs	WR86-1436SG-5	90 lbs	AD86-1436SG-5	83 lbs
14" x 42"	WR74-1442SG-5	91 lbs	AD74-1442SG-5	86 lbs	WR86-1442SG-5	95 lbs	AD86-1442SG-5	88 lbs
14" x 48"	WR74-1448SG-5	101 lbs	AD74-1448SG-5	91 lbs	WR86-1448SG-5	105 lbs	AD86-1448SG-5	98 lbs
14" x 54"	WR74-1454SG-5	116 lbs	AD74-1454SG-5	111 lbs	WR86-1454SG-5	120 lbs	AD86-1454SG-5	113 lbs
14" x 60"	WR74-1460SG-5	126 lbs	AD74-1460SG-5	121 lbs	WR86-1460SG-5	130 lbs	AD86-1460SG-5	123 lbs
14" x 72"	WR74-1472SG-5	146 lbs	AD74-1472SG-5	141 lbs	WR86-1472SG-5	150 lbs	AD86-1472SG-5	143 lbs
18" x 24"	WR74-1824SG-5	71 lbs	AD74-1824SG-5	66 lbs	WR86-1824SG-5	75 lbs	AD86-1824SG-5	68 lbs
18" x 30"	WR74-1830SG-5	86 lbs	AD74-1830SG-5	81 lbs	WR86-1830SG-5	90 lbs	AD86-1830SG-5	83 lbs
18" x 36"	WR74-1836SG-5	96 lbs	AD74-1836SG-5	91 lbs	WR86-1836SG-5	100 lbs	AD86-1836SG-5	93 lbs
18" x 42"	WR74-1842SG-5	106 lbs	AD74-1842SG-5	101 lbs	WR86-1842SG-5	110 lbs	AD86-1842SG-5	103 lbs
18" x 48"	WR74-1848SG-5	116 lbs	AD74-1848SG-5	111 lbs	WR86-1848SG-5	120 lbs	AD86-1848SG-5	113 lbs
18" x 54"	WR74-1854SG-5	126 lbs	AD74-1854SG-5	121 lbs	WR86-1854SG-5	130 lbs	AD86-1854SG-5	123 lbs
18" x 60"	WR74-1860SG-5	136 lbs	AD74-1860SG-5	131 lbs	WR86-1860SG-5	140 lbs	AD86-1860SG-5	133 lbs
18" x 72"	WR74-1872SG-5	151 lbs	AD74-1872SG-5	151 lbs	WR86-1872SG-5	155 lbs	AD86-1872SG-5	153 lbs
21" x 24"	WR74-2124SG-5	81 lbs	AD74-2124SG-5	76 lbs	WR86-2124SG-5	85 lbs	AD86-2124SG-5	78 lbs
21" x 30"	WR74-2130SG-5	91 lbs	AD74-2130SG-5	86 lbs	WR86-2130SG-5	95 lbs	AD86-2130SG-5	88 lbs
21" x 36"	WR74-2136SG-5	106 lbs	AD74-2136SG-5	101 lbs	WR86-2136SG-5	110 lbs	AD86-2136SG-5	103 lbs
21" x 42"	WR74-2142SG-5	121 lbs	AD74-2142SG-5	116 lbs	WR86-2142SG-5	125 lbs	AD86-2142SG-5	118 lbs
21" x 48"	WR74-2148SG-5	131 lbs	AD74-2148SG-5	121 lbs	WR86-2148SG-5	135 lbs	AD86-2148SG-5	123 lbs
21" x 54"	WR74-2154SG-5	141 lbs	AD74-2154SG-5	136 lbs	WR86-2154SG-5	145 lbs	AD86-2154SG-5	138 lbs
21" x 60"	WR74-2160SG-5	156 lbs	AD74-2160SG-5	151 lbs	WR86-2160SG-5	160 lbs	AD86-2160SG-5	153 lbs
21" x 72"	WR74-2172SG-5	166 lbs	AD74-2172SG-5	166 lbs	WR86-2172SG-5	170 lbs	AD86-2172SG-5	168 lbs
24" x 24"	WR74-2424SG-5	91 lbs	AD74-2424SG-5	86 lbs	WR86-2424SG-5	95 lbs	AD86-2424SG-5	88 lbs
24" x 30"	WR74-2430SG-5	101 lbs	AD74-2430SG-5	96 lbs	WR86-2430SG-5	105 lbs	AD86-2430SG-5	98 lbs
24" x 36"	WR74-2436SG-5	111 lbs	AD74-2436SG-5	106 lbs	WR86-2436SG-5	115 lbs	AD86-2436SG-5	108 lbs
24" x 42"	WR74-2442SG-5	126 lbs	AD74-2442SG-5	121 lbs	WR86-2442SG-5	130 lbs	AD86-2442SG-5	123 lbs
24" x 48"	WR74-2448SG-5	136 lbs	AD74-2448SG-5	131 lbs	WR86-2448SG-5	140 lbs	AD86-2448SG-5	133 lbs
24" x 54"	WR74-2454SG-5	156 lbs	AD74-2454SG-5	151 lbs	WR86-2454SG-5	160 lbs	AD86-2454SG-5	153 lbs
24" x 60"	WR74-2460SG-5	171 lbs	AD74-2460SG-5	166 lbs	WR86-2460SG-5	175 lbs	AD86-2460SG-5	168 lbs
24" x 72"	WR74-2472SG-5	186 lbs	AD74-2472SG-5	186 lbs	WR86-2472SG-5	205 lbs	AD86-2472SG-5	198 lbs

Shelving units include 4 posts and 5 shelves. Add-On units include 2 posts, 5 shelves and 10 shelf clamps.

5 Shelf Starter Kits

Solid shelves are a solution where dirt, dust and spills are a potential issue. The solid flat surface allows for storage from small to large items and the marine edge perimeter prevents spillage. The double hemmed 18 gauge galvanized steel gives the solid shelf excellent strength characteristics. All solid shelf units consist of 5 shelves and 4 posts. Mobilize starter kit shelving unit using optional mobile kit **WR-00H**. See pg. 79. **Finish:** Galvanized Steel



MOBILIZE YOUR SHELVING

DB - Donut Bumper

Non-marking donut bumper used to protect walls and help cushion impact.

WR-00H (Mobile Kit)*

Set of four swivel polyurethane 5" x 1-1/4" casters, two with brakes. Can be used with all units shown. 1,200 lb. load capacity. *Mobile kits recommended only for shelves 18" and wider.



QSMC

Shelf Clamp

Shelf Clamp eliminates 2 post per shelving section. Two QSMC clamps are required per shelf. **Finish:** Aluminum



ADD-ON KIT

5 Shelf Add-On Kits

Additional Add-On kit allows you to expand your Starter kit by sharing a set of posts. Configuration options include straight line, back to back and right angles (L-Shape). Add-On units consist of 5 shelves, 2 posts and 10 shelf clamps. Additional shelves may be purchased separately. See chart on pg. 39. Units with Add-On kit cannot be made mobile. **Finish:** Galvanized Steel

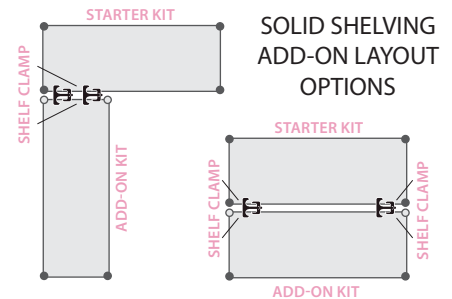
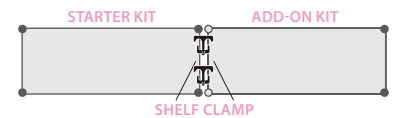

SOLID SHELVING ADD-ON LAYOUT OPTIONS



Modular Wire Stacking Baskets

Offer a variety of storage, display and mobile supply applications. Dividers can be used to separate product. Accessible front and a wide selection of sizes allow for all types of product to be used from storage to display. (Dividers sold separately) **Finish:** Chrome



1436BC
Shown with Dividers and Clear Label Holder (Sold separately)

CLEAR LABEL HOLDERS
A user friendly method for identifying product. Affix directly to the front on any basket. Available in three lengths. (Sold separately)

MODEL NO.	DESCRIPTION	SHIP WGT
Clear Label Holders		
BLH3C	3" Clear Label Holder	1 lb
BLH14C	14" Clear Label Holder	1 lb
BLH32C	32" Clear Label Holder	1 lb

MODEL NO.	BASKET DIMENSIONS W" x L" x H"	SHIP WGT	DIVIDER MODEL NO.	SHIP WGT
1436BC	14" x 36" x 9"	10 lbs	149DC	1 lb
1448BC	14" x 48" x 9"	13 lbs	149DC	1 lb
2036BC	20" x 36" x 9"	12 lbs	209DC	2 lbs
2048BC	20" x 48" x 9"	15 lbs	209DC	2 lbs
203612BC	20" x 36" x 12"	14 lbs	2012DC	2 lbs
204812BC	20" x 48" x 12"	16 lbs	2012DC	2 lbs



WR5-36MSBA

FOR ALL TYPES
of products!



DOLLY BASE

WR5-36MSBA-MOB

Build & stack any combination of baskets for your requirements. Larger baskets must be positioned on the lowest point.

Stationary Stacking Baskets

Order this exact unit

WR5-36MSBA

Unit consists of:

- 2 - baskets **1436BC**
- 2 - dividers **149DC**
- 3 - baskets **203612BC**
- 3 - dividers **2012DC**

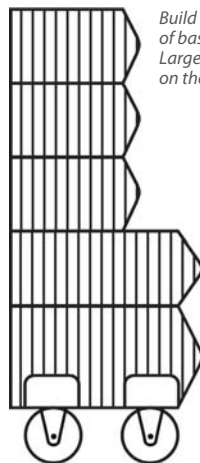

Dolly Base

Includes four 5" swivel casters which offers versatility to any unit.

MODEL NO.	DIMENSIONS W" x L"	SHIP WGT
M2036BD	20" x 36"	32 lbs
M2048BD	20" x 48"	34 lbs

Mobile Stacking Baskets

Order this exact unit

WR5-36MSBA-MOB

Unit consists of:

- 2 - baskets **1436BC**
- 2 - dividers **149DC**
- 3 - baskets **203612BC**
- 3 - dividers **2012DC**
- 1 - dolly **M2036BD**



**BASKET ADJUST ON 1" INCREMENTS
3 POSITIONS FOR MAXIMIZING EFFICIENCY.**



Angle Down
Flows parts to front
Provides maximum
accessibility



Flat
Provides maximum
space efficiency



Angled Up
Provides maximum
bin capacity

Modular Wire Basket Units

Basket units allow high visibility and air circulation. The basket acts as a dispensing and storage module which can be added to 18", 21" and 24" deep shelving units. The collar hook allows the basket to be removed or adjusted to accommodate various product mix and sizes. Baskets are adjustable on 1" increments. 110 lb. load capacity per basket. Adjustable baskets used in combination with shelves are an excellent method to store all types of products. Units can be stationary or mobile. Casters add flexibility and convert stationary units into transport systems. Ideal for exchange charts and par level storage. *(Dividers sold separately)* **Finish:** Chrome



M1836BC6C
(Dividers sold separately)



COLLAR HOOKS
Hooks onto basket corner
allowing basket to securely hang.

MODEL NO.	DESCRIPTION	SHIP WGT
SCH1-5	Four 1-1/2" Collar Hooks	1 lb
SCH1	Four 1/2" Collar Hooks	1 lb



1836BC6C
(Dividers sold separately)

Mobile Wire Basket Units

Each mobile unit consists of:

- 4 - 63"H posts
- 3 - 9"H adjustable baskets including collar hooks
- 2 - wire shelves
- 4 - donut bumpers
- 4 - 5" x 1-1/4" swivel polyurethane casters, 2 with brake

STATIONARY MODEL NO.	DIMENSIONS W" x L" x H"	NO. OF SHELVES	NO. OF BASKETS	SHIP WGT
M1836BC6C	18" x 36" x 69"	2	3	78 lbs
M1848BC6C	18" x 48" x 69"	2	3	90 lbs
M2436BC6C	24" x 36" x 69"	2	3	93 lbs
M2448BC6C	24" x 48" x 69"	2	3	108 lbs

Stationary Wire Basket Units

Each stationary unit consists of:

- 4 - 63"H posts
- 3 - 9"H adjustable baskets including collar hooks
- 2 - wire shelves

STATIONARY MODEL NO.	DIMENSIONS W" x L" x H"	NO. OF SHELVES	NO. OF BASKETS	SHIP WGT
1836BC6C	18" x 36" x 63"	2	3	70 lbs
1848BC6C	18" x 48" x 63"	2	3	82 lbs
2436BC6C	24" x 36" x 63"	2	3	85 lbs
2448BC6C	24" x 48" x 63"	2	3	100 lbs

Post Baskets

Quantum's new hanging baskets are manufactured of heavy-duty chrome wire offering a 5/8" x 5/8" mesh design on the bottom/flat surface. Super heavy-duty design affords a 600-800 lb. load capacity evenly distributed. Drop front and sloped sides provide super easy access while providing a captive space for all stored items. Baskets are adjustable on 1" increments utilizing standard 1" diameter posts. **Finish:** Chrome

HIGH VISIBILITY! EASY TO CLEAN!
ALL WELDED!

MODEL NO.	DIMENSIONS W" x L" x H"	SHIP WGT
BSK1824C	18" x 24" x 10"	10 lbs
BSK1836C	18" x 36" x 10"	15 lbs
BSK1848C	18" x 48" x 10"	20 lbs
BSK1860C	18" x 60" x 10"	25 lbs
BSK2424C	24" x 24" x 10"	15 lbs
BSK2436C	24" x 36" x 10"	20 lbs
BSK2448C	24" x 48" x 10"	25 lbs
BSK2460C	24" x 60" x 10"	30 lbs

new



BSK1836C

COMPLETE CARTS INCLUDE
caster kit for mobility!

Mobile 4 Post Basket Units

Each mobile unit consists of:

- 4 - 74"H posts
- 4 - post basket
- 3 - wire shelf
- Finish:** Chrome
- 1 - shelf inlay mat
- 4 - donut bumpers
- 4 - 5" x 1-1/4" swivel polyurethane casters, 2 with brake

MODEL NO.	DIMENSIONS W" x L" x H"	SHIP WGT
WRC74-1824C-4BSK	18" x 24" x 80"	94 lbs
WRC74-1836C-4BSK	18" x 36" x 80"	127 lbs
WRC74-1848C-4BSK	18" x 48" x 80"	160 lbs
WRC74-1860C-4BSK	18" x 60" x 80"	197 lbs
WRC74-2424C-4BSK	24" x 24" x 80"	125 lbs
WRC74-2436C-4BSK	24" x 36" x 80"	158 lbs
WRC74-2448C-4BSK	24" x 48" x 80"	191 lbs
WRC74-2460C-4BSK	24" x 60" x 80"	228 lbs

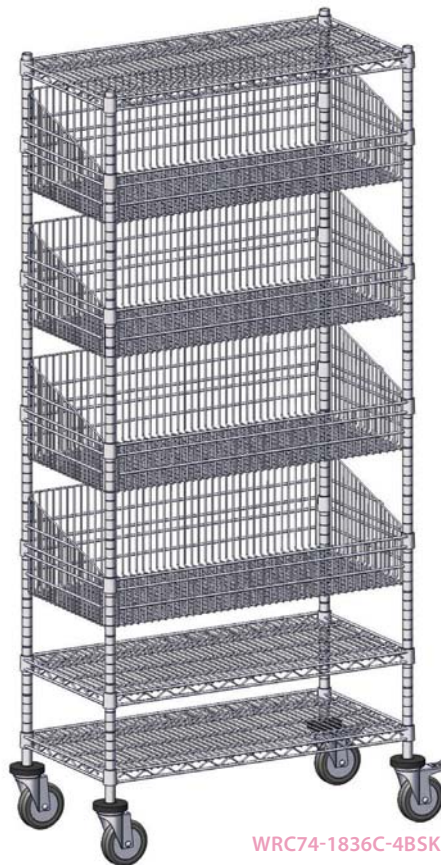

WRC74-1836C-4BSK

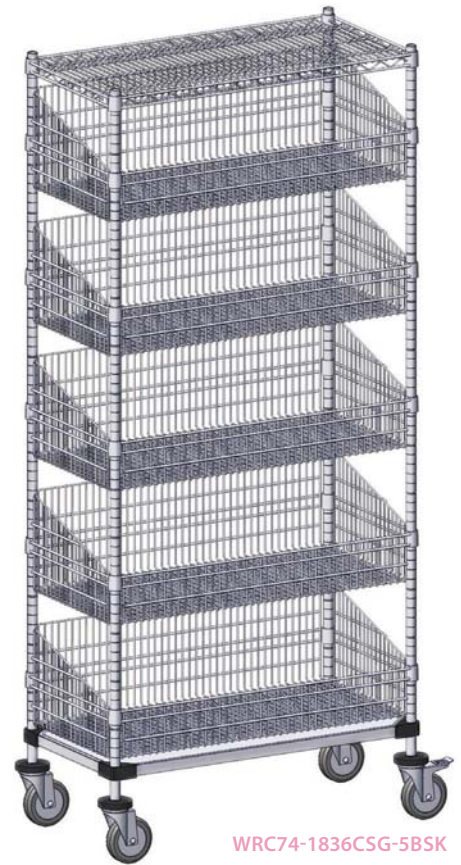

WRC74-1836CSG-5BSK

Mobile 5 Post Basket Units

Each mobile unit consists of:

- 4 - 74"H posts
- 5 - post basket
- 1 - wire shelf
- Finish:** Chrome
- 1 - solid shelf
- Finish:** Galvanized Steel
- 4 - donut bumpers
- 4 - 5" x 1-1/4" swivel polyurethane casters, 2 with brake

MODEL NO.	DIMENSIONS W" x L" x H"	SHIP WGT
WRC74-1824CSG-5BSK	18" x 24" x 80"	94 lbs
WRC74-1836CSG-5BSK	18" x 36" x 80"	127 lbs
WRC74-1848CSG-5BSK	18" x 48" x 80"	160 lbs
WRC74-1860CSG-5BSK	18" x 60" x 80"	197 lbs
WRC74-2424CSG-5BSK	24" x 24" x 80"	125 lbs
WRC74-2436CSG-5BSK	24" x 36" x 80"	158 lbs
WRC74-2448CSG-5BSK	24" x 48" x 80"	191 lbs
WRC74-2460CSG-5BSK	24" x 60" x 80"	228 lbs

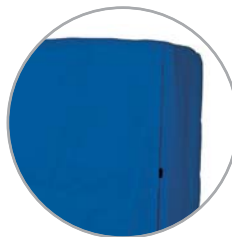

BLUE NYLON



CLEAR VINYL

NYLON FABRIC
OR CLEAR VINYL
CART COVERS
AVAILABLE!
See pg. 61

CART COVERS
Protect against pilferage, airborne
dust, water and other contaminants!



WRCGR-63-2436

**NYLON FABRIC
OR CLEAR VINYL
CART COVERS**

AVAILABLE!
See pg. 61



WHITE NYLON

COMPLETE CARTS INCLUDE
caster kit for mobility!



WRCPL-63-2460

Stationary and Mobile Wire Garment Racks

Ideal storage rack for hanging any type of coat or garment. Includes handy bottom shelf for additional storage.

Finish: Chrome

Each unit consists of:

- 4 - 63" posts
- 2 - wire shelves
- 1 - hang bar

Mobile Unit also includes:

- 4 - 5" swivel poly stem casters, 2 with brake
- 4 - donut bumpers

MODEL NO.	NO. OF SHELVES	DIMENSIONS W" x L" x H"	SHIP WGT
Stationary Wire Garment Racks			
WRGR-63-2436	2	24" x 36" x 63"	45 lbs
WRGR-63-2448	2	24" x 48" x 63"	52 lbs
WRGR-63-2460	2	24" x 60" x 63"	63 lbs
Mobile Wire Garment Racks			
WRCGR-63-2436	2	24" x 36" x 69"	59 lbs
WRCGR-63-2448	2	24" x 48" x 69"	66 lbs
WRCGR-63-2460	2	24" x 60" x 69"	77 lbs

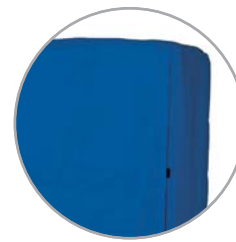

BLUE NYLON



CLEAR VINYL

CART COVERS

Protect against pilferage, airborne dust, water and other contaminants!

Patient Apparel Cart

Ideal for patient care situations where the distribution and holding of apparel is required. The horizontal bar accommodates hangers and the shelves are divided into separate visible compartments. **Finish:** Chrome

Each unit consists of:

- 4 - 63" posts
- 2 - 54" posts
- 2 - 24" X 60" wire shelves
- 3 - 24" X 36" wire shelves
- 8 - 24" dividers
- 2 - 61" rods & tabs kits
- 1 - 24" hang bar
- 4 - 5" swivel poly stem casters, 2 with brake
- 4 - donut bumpers

MODEL NO.	NO. OF SHELVES	DIMENSIONS L" x W" x H"	SHIP WGT
WRCPL-63-2460	5	24" x 60" x 69"	146 lbs

Stem Caster Carts



M1836C46



M1836CG46



M1836SG46

4 Wire Shelf Mobile Carts

Mobile wire stem caster carts add versatility & flexibility to any operation, creating a transport system.

- Central supply & distribution
- Stock rotation
- Laundry
- Staging

Each unit consists of:

- 4 - posts
- 4 - wire shelves
- 4 - donut bumpers
- 4 - 5" poly stem casters, 2 with brake

3 Wire / 1 Solid Shelf Mobile Carts

Stem caster cart with solid bottom shelf. The unique combination of wire and solid shelves allows for air circulation & high visibility. The solid shelf in the bottom position prevents dust and dirt to rise and contains spillage.

Each unit consists of:

- 4 - posts
- 3 - wire shelves
- 1 - solid shelf
- 4 - donut bumpers
- 4 - 5" poly stem casters, 2 with brake

4 Solid Shelf Mobile Carts

Stem caster solid shelf cart is an easy way to transport fluids & small packaged items.

Each unit consists of:

- 4 - posts
- 4 - solid shelves
- 4 - donut bumpers
- 4 - 5" poly stem casters, 2 with brake

MODEL NO.	DIMENSIONS W" x L" x H"	SHIP WGT
63"H Post, 5" Stem Caster Unit		
M1836C46	18" x 36" x 69"	62 lbs
M1848C46	18" x 48" x 69"	70 lbs
M1860C46	18" x 60" x 69"	90 lbs
M2436C46	24" x 36" x 69"	74 lbs
M2448C46	24" x 48" x 69"	86 lbs
M2460C46	24" x 60" x 69"	106 lbs
74"H Post, 5" Stem Caster Unit		
M1836C47	18" x 36" x 80"	64 lbs
M1848C47	18" x 48" x 80"	72 lbs
M1860C47	18" x 60" x 80"	92 lbs
M2436C47	24" x 36" x 80"	76 lbs
M2448C47	24" x 48" x 80"	88 lbs
M2460C47	24" x 60" x 80"	108 lbs

MODEL NO.	DIMENSIONS W" x L" x H"	SHIP WGT
63"H Post, 5" Stem Caster Unit		
M1836CG46	18" x 36" x 69"	68 lbs
M1848CG46	18" x 48" x 69"	76 lbs
M1860CG46	18" x 60" x 69"	97 lbs
M2436CG46	24" x 36" x 69"	80 lbs
M2448CG46	24" x 48" x 69"	94 lbs
M2460CG46	24" x 60" x 69"	116 lbs
74"H Post, 5" Stem Caster Unit		
M1836CG47	18" x 36" x 80"	70 lbs
M1848CG47	18" x 48" x 80"	78 lbs
M1860CG47	18" x 60" x 80"	99 lbs
M2436CG47	24" x 36" x 80"	82 lbs
M2448CG47	24" x 48" x 80"	96 lbs
M2460CG47	24" x 60" x 80"	118 lbs

MODEL NO.	DIMENSIONS W" x L" x H"	SHIP WGT
63"H Post, 5" Stem Caster Unit		
M1836SG46	18" x 36" x 69"	86 lbs
M1848SG46	18" x 48" x 69"	102 lbs
M1860SG46	18" x 60" x 69"	118 lbs
M2436SG46	24" x 36" x 69"	98 lbs
M2448SG46	24" x 48" x 69"	102 lbs
M2460SG46	24" x 60" x 69"	146 lbs
74"H Post, 5" Stem Caster Unit		
M1836SG47	18" x 36" x 80"	88 lbs
M1848SG47	18" x 48" x 80"	104 lbs
M1860SG47	18" x 60" x 80"	120 lbs
M2436SG47	24" x 36" x 80"	100 lbs
M2448SG47	24" x 48" x 80"	104 lbs
M2460SG47	24" x 60" x 80"	148 lbs

Stem Caster Carts



M1836C46-5



M1836CG46-5



M1836SG46-5

5 Wire Shelf Mobile Carts

Mobile wire stem caster carts add versatility & flexibility to any operation, creating a transport system.

- Central supply & distribution
- Stock rotation
- Laundry
- Staging

Each unit consists of:

- 4 - posts
- 5 - wire shelves
- 4 - donut bumpers
- 4 - 5" poly stem casters, 2 with brake

MODEL NO.	DIMENSIONS W" x L" x H"	SHIP WGT
63"H Post, 5" Stem Caster Unit		
M1836C46-5	18" x 36" x 69"	72 lbs
M1848C46-5	18" x 48" x 69"	84 lbs
M1860C46-5	18" x 60" x 69"	107 lbs
M2436C46-5	24" x 36" x 69"	87 lbs
M2448C46-5	24" x 48" x 69"	102 lbs
M2460C46-5	24" x 60" x 69"	127 lbs
74"H Post, 5" Stem Caster Unit		
M1836C47-5	18" x 36" x 80"	74 lbs
M1848C47-5	18" x 48" x 80"	86 lbs
M1860C47-5	18" x 60" x 80"	109 lbs
M2436C47-5	24" x 36" x 80"	89 lbs
M2448C47-5	24" x 48" x 80"	104 lbs
M2460C47-5	24" x 60" x 80"	129 lbs

4 Wire / 1 Solid Shelf Mobile Carts

Stem caster cart with solid bottom shelf. The unique combination of wire and solid shelves allows for air circulation & high visibility. The solid shelf in the bottom position prevents dust and dirt to rise and contains spillage.

Each unit consists of:

- 4 - posts
- 4 - wire shelves
- 1 - solid shelf
- 4 - donut bumpers
- 4 - 5" poly stem casters, 2 with brake

MODEL NO.	DIMENSIONS W" x L" x H"	SHIP WGT
63"H Post, 5" Stem Caster Unit		
M1836CG46-5	18" x 36" x 69"	78 lbs
M1848CG46-5	18" x 48" x 69"	90 lbs
M1860CG46-5	18" x 60" x 69"	114 lbs
M2436CG46-5	24" x 36" x 69"	93 lbs
M2448CG46-5	24" x 48" x 69"	110 lbs
M2460CG46-5	24" x 60" x 69"	137 lbs
74"H Post, 5" Stem Caster Unit		
M1836CG47-5	18" x 36" x 80"	80 lbs
M1848CG47-5	18" x 48" x 80"	92 lbs
M1860CG47-5	18" x 60" x 80"	116 lbs
M2436CG47-5	24" x 36" x 80"	95 lbs
M2448CG47-5	24" x 48" x 80"	112 lbs
M2460CG47-5	24" x 60" x 80"	139 lbs

5 Solid Shelf Mobile Carts

Stem caster solid shelf cart is an easy way to transport fluids & small packaged items.

Each unit consists of:

- 4 - posts
- 5 - solid shelves
- 4 - donut bumpers
- 4 - 5" poly stem casters, 2 with brake

MODEL NO.	DIMENSIONS W" x L" x H"	SHIP WGT
63"H Post, 5" Stem Caster Unit		
M1836SG46-5	18" x 36" x 69"	102 lbs
M1848SG46-5	18" x 48" x 69"	122 lbs
M1860SG46-5	18" x 60" x 69"	142 lbs
M2436SG46-5	24" x 36" x 69"	117 lbs
M2448SG46-5	24" x 48" x 69"	126 lbs
M2460SG46-5	24" x 60" x 69"	177 lbs
74"H Post, 5" Stem Caster Unit		
M1836SG47-5	18" x 36" x 80"	104 lbs
M1848SG47-5	18" x 48" x 80"	124 lbs
M1860SG47-5	18" x 60" x 80"	144 lbs
M2436SG47-5	24" x 36" x 80"	119 lbs
M2448SG47-5	24" x 48" x 80"	128 lbs
M2460SG47-5	24" x 60" x 80"	179 lbs



M1836C46RE



MD1836C46RE



M2436C46E

Enclosure Carts

Enclosure carts are an effective way to keep contents from moving or falling off during transportation.

Enclosure carts using rods and tabs are adaptable to any shelf position.

Enclosure dolly base truck using rods & tabs allows for heavier load transport. The rods & tabs act as a perimeter to retain product.

For additional shelves, refer to pg. 38.

3 SIDED, 4 WIRE SHELF CART WITH RODS & TABS

MODEL NO.	DIMENSIONS W" x L" x H"	SHIP WGT
63"H Post, Unit with Rods and Tabs		
M1836C46RE	18" x 36" x 69"	74 lbs
M1848C46RE	18" x 48" x 69"	84 lbs
M1860C46RE	18" x 60" x 69"	100 lbs
M2436C46RE	24" x 36" x 69"	88 lbs
M2448C46RE	24" x 48" x 69"	104 lbs
M2460C46RE	24" x 60" x 69"	124 lbs
74"H Post, Unit with Rods and Tabs		
M1836C47RE	18" x 36" x 80"	80 lbs
M1848C47RE	18" x 48" x 80"	92 lbs
M1860C47RE	18" x 60" x 80"	104 lbs
M2436C47RE	24" x 36" x 80"	94 lbs
M2448C47RE	24" x 48" x 80"	112 lbs
M2460C47RE	24" x 60" x 80"	132 lbs

All units consist of:

- 4 - posts
- 4 - wire shelves
- 4, 5 or 6 - rods & tabs kits

Mobile unit also includes:

- 4 - 5" swivel poly stem casters, 2 with brake
- 4 - donut bumpers

Dolly Base unit also includes:

- 1 - dolly base
- 4 - plate casters, 2 rigid and 2 swivel with brake

DOLLY BASE 3 SIDED, 4 WIRE SHELF CART WITH RODS & TABS

MODEL NO.	DIMENSIONS W" x L" x H"	SHIP WGT
63"H Post, Dolly Base Unit		
MD1836C46RE	18" x 36" x 70"	86 lbs
MD1848C46RE	18" x 48" x 70"	96 lbs
MD1860C46RE	18" x 60" x 70"	124 lbs
MD2436C46RE	24" x 36" x 70"	113 lbs
MD2448C46RE	24" x 48" x 70"	121 lbs
MD2460C46RE	24" x 60" x 70"	144 lbs
74"H Post, Dolly Base Unit		
MD1836C47RE	18" x 36" x 81"	92 lbs
MD1848C47RE	18" x 48" x 81"	106 lbs
MD1860C47RE	18" x 60" x 81"	120 lbs
MD2436C47RE	24" x 36" x 81"	108 lbs
MD2448C47RE	24" x 48" x 81"	129 lbs
MD2460C47RE	24" x 60" x 81"	152 lbs

Enclosure Linen Carts

Finish: Chrome

Each unit consists of:

- 4 - posts
- 4 - wire shelves
- 4 or 5 - enclosure panels
- 4 - 5" swivel poly stem casters, 2 with brake
- 4 - donut bumpers

COMPLETE CARTS INCLUDE
caster kit for mobility!

3 SIDED, 4 WIRE SHELF CART WITH ENCLOSURE PANELS

MODEL NO.	DIMENSIONS W" x L" x H"	SHIP WGT
63"H Post, Unit with Enclosure Panels		
M2436C46E	24" x 36" x 69"	145 lbs
M2448C46E	24" x 48" x 69"	179 lbs
M2460C46E	24" x 60" x 69"	197 lbs



M2436C46E-5



M1836C46RE-5



MD1836C46RE-5

Enclosure Linen Carts

Finish: Chrome

Each unit consists of:

- 4 - posts
- 5 - wire shelves
- 4 or 5 - enclosure panels
- 4 - 5" swivel poly stem casters, 2 with brake
- 4 - donut bumpers

Enclosure Carts

Enclosure carts are an effective way to keep contents from moving or falling off during transportation.

Enclosure carts using rods and tabs are adaptable to any shelf position.

Enclosure dolly base truck using rods & tabs allows for heavier load transport. The rods & tabs act as a perimeter to retain product.

For additional shelves, refer to pg. 38.

All units consist of:

- 4 - posts
- 5 - wire shelves
- 4, 5 or 6 - rods & tabs kits

Mobile unit also includes:

- 4 - 5" swivel poly stem casters, 2 with brake
- 4 - donut bumpers

Dolly Base unit also includes:

- 1 - dolly base
- 4 - plate casters, 2 rigid and 2 swivel with brake

COMPLETE CARTS
INCLUDE
caster kit for mobility!

3 SIDED, 5 WIRE SHELF CART
WITH ENCLOSURE PANELS

MODEL NO.	DIMENSIONS W" x L" x H"	SHIP WGT
63"H Post, Unit with Enclosure Panels		
M2436C46E-5	24" x 36" x 69"	158 lbs
M2448C46E-5	24" x 48" x 69"	195 lbs
M2460C46E-5	24" x 60" x 69"	218 lbs

3 SIDED, 5 WIRE SHELF CART
WITH RODS & TABS

MODEL NO.	DIMENSIONS W" x L" x H"	SHIP WGT
63"H Post, Unit with Rods and Tabs		
M1836C46RE-5	18" x 36" x 69"	84 lbs
M1848C46RE-5	18" x 48" x 69"	98 lbs
M1860C46RE-5	18" x 60" x 69"	117 lbs
M2436C46RE-5	24" x 36" x 69"	101 lbs
M2448C46RE-5	24" x 48" x 69"	120 lbs
M2460C46RE-5	24" x 60" x 69"	145 lbs
74"H Post, Unit with Rods and Tabs		
M1836C47RE-5	18" x 36" x 80"	90 lbs
M1848C47RE-5	18" x 48" x 80"	106 lbs
M1860C47RE-5	18" x 60" x 80"	121 lbs
M2436C47RE-5	24" x 36" x 80"	107 lbs
M2448C47RE-5	24" x 48" x 80"	128 lbs
M2460C47RE-5	24" x 60" x 80"	153 lbs

DOLLY BASE 3 SIDED, 5 WIRE SHELF CART
WITH RODS & TABS

MODEL NO.	DIMENSIONS W" x L" x H"	SHIP WGT
63"H Post, Dolly Base Unit		
MD1836C46RE-5	18" x 36" x 70"	96 lbs
MD1848C46RE-5	18" x 48" x 70"	110 lbs
MD1860C46RE-5	18" x 60" x 70"	141 lbs
MD2436C46RE-5	24" x 36" x 70"	126 lbs
MD2448C46RE-5	24" x 48" x 70"	137 lbs
MD2460C46RE-5	24" x 60" x 70"	165 lbs
74"H Post, Dolly Base Unit		
MD1836C47RE-5	18" x 36" x 81"	102 lbs
MD1848C47RE-5	18" x 48" x 81"	120 lbs
MD1860C47RE-5	18" x 60" x 81"	137 lbs
MD2436C47RE-5	24" x 36" x 81"	121 lbs
MD2448C47RE-5	24" x 48" x 81"	145 lbs
MD2460C47RE-5	24" x 60" x 81"	173 lbs



M1836CG46RE



MD1836CG46RE

**COMPLETE CARTS
INCLUDE
caster kit for mobility!**



QSRT
Side/Solid Shelf Tab



QAT
Front/Back Tab

Enclosure Carts

Enclosure carts are an effective way to keep contents from moving or falling off during transportation.

Enclosure carts using rods and tabs are adaptable to any shelf position.

Enclosure dolly base truck using rods & tabs allows for heavier load transport. The rods & tabs act as a perimeter to retain product.

For additional shelves, refer to pg. 38.

**3 SIDED STEM CASTER WIRE SHELF CART
WITH 3 WIRE SHELVES AND 1 SOLID SHELF
WITH RODS & TABS**

MODEL NO.	DIMENSIONS W" x L" x H"	SHIP WGT
63"H Post, Unit with Rods and Tabs		
M1836CG46RE	18" x 36" x 69"	83 lbs
M1848CG46RE	18" x 48" x 69"	94 lbs
M1860CG46RE	18" x 60" x 69"	114 lbs
M2436CG46RE	24" x 36" x 69"	96 lbs
M2448CG46RE	24" x 48" x 69"	112 lbs
M2460CG46RE	24" x 60" x 69"	136 lbs
74"H Post, Unit with Rods and Tabs		
M1836CG47RE	18" x 36" x 80"	89 lbs
M1848CG47RE	18" x 48" x 80"	101 lbs
M1860CG47RE	18" x 60" x 80"	123 lbs
M2436CG47RE	24" x 36" x 80"	102 lbs
M2448CG47RE	24" x 48" x 80"	119 lbs
M2460CG47RE	24" x 60" x 80"	145 lbs

All units consist of:

- 4 - posts
- 3 - wire shelves
- 1 - Solid shelf
- 4, 5 or 6 - rods & tabs kits

Mobile unit also includes:

- 4 - 5" swivel poly stem casters, 2 with brake
- 4 - donut bumpers

Dolly Base unit also includes:

- 1 - dolly base
- 4 - plate casters, 2 rigid and 2 swivel with brake

**DOLLY BASE 3 SIDED WIRE SHELF CART
WITH 3 WIRE SHELVES AND 1 SOLID SHELF
WITH RODS & TABS**

MODEL NO.	DIMENSIONS W" x L" x H"	SHIP WGT
64"H Post, Dolly Base Unit		
MD1836CG46RE	18" x 36" x 70"	93 lbs
MD1848CG46RE	18" x 48" x 70"	106 lbs
MD1860CG46RE	18" x 60" x 70"	128 lbs
MD2436CG46RE	24" x 36" x 70"	109 lbs
MD2448CG46RE	24" x 48" x 70"	127 lbs
MD2460CG46RE	24" x 60" x 70"	154 lbs
74"H Post, Dolly Base Unit		
MD1836CG47RE	18" x 36" x 81"	99 lbs
MD1848CG47RE	18" x 48" x 81"	113 lbs
MD1860CG47RE	18" x 60" x 81"	137 lbs
MD2436CG47RE	24" x 36" x 81"	115 lbs
MD2448CG47RE	24" x 48" x 81"	134 lbs
MD2460CG47RE	24" x 60" x 81"	163 lbs

Rods & Tabs

Rods & tabs represent an economical, alternate solution for enclosure on backs and sides of mobile and stationary units.

Each kit includes:

- 3 - rods
- 9 - front/back tabs
- 9 - side/solid shelf tabs

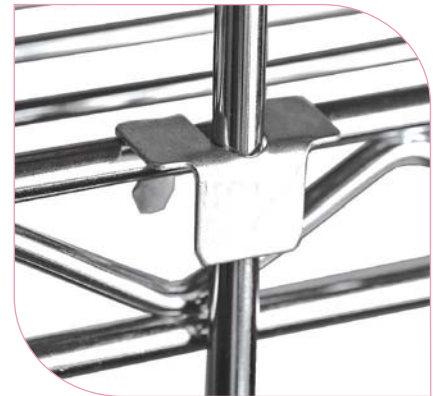

MODEL NO.	DESCRIPTION	SHIP WGT
Rods & Tabs		
52RT	3 - 52" Rods with tabs	1 lb
61RT	3 - 61" Rods with tabs	1 lb
72RT	3 - 72" Rods with tabs	2 lbs
84RT	3 - 84" Rods with tabs	2 lbs



M1836CG46RE-5



MD1836CG46RE-5

**COMPLETE CARTS
INCLUDE
caster kit for mobility!**



QSR
Side/Solid Shelf Tab



QAT
Front/Back Tab

Enclosure Carts

Enclosure carts are an effective way to keep contents from moving or falling off during transportation.

Enclosure carts using rods and tabs are adaptable to any shelf position.

Enclosure dolly base truck using rods & tabs allows for heavier load transport. The rods & tabs act as a perimeter to retain product.

For additional shelves, refer to pg. 38.

**3 SIDED STEM CASTER WIRE SHELF CART
WITH 4 WIRE SHELVES AND 1 SOLID SHELF
WITH RODS & TABS**

MODEL NO.	DIMENSIONS W" x L" x H"	SHIP WGT
63"H Post, Unit with Rods and Tabs		
M1836CG46RE-5	18" x 36" x 69"	93 lbs
M1848CG46RE-5	18" x 48" x 69"	108 lbs
M1860CG46RE-5	18" x 60" x 69"	131 lbs
M2436CG46RE-5	24" x 36" x 69"	109 lbs
M2448CG46RE-5	24" x 48" x 69"	128 lbs
M2460CG46RE-5	24" x 60" x 69"	157 lbs
74"H Post, Unit with Rods and Tabs		
M1836CG47RE-5	18" x 36" x 80"	99 lbs
M1848CG47RE-5	18" x 48" x 80"	115 lbs
M1860CG47RE-5	18" x 60" x 80"	140 lbs
M2436CG47RE-5	24" x 36" x 80"	115 lbs
M2448CG47RE-5	24" x 48" x 80"	135 lbs
M2460CG47RE-5	24" x 60" x 80"	166 lbs

All units consist of:

- 4 - posts
- 4 - wire shelves
- 1 - solid shelf
- 4, 5 or 6 - rods & tabs kits

Mobile unit also includes:

- 4 - 5" swivel poly stem casters, 2 with brake
- 4 - donut bumpers

Dolly Base unit also includes:

- 1 - dolly base
- 4 - plate casters, 2 rigid and 2 swivel with brake

**DOLLY BASE 3 SIDED WIRE SHELF CART
WITH 4 WIRE SHELVES AND 1 SOLID SHELF
WITH RODS & TABS**

MODEL NO.	DIMENSIONS W" x L" x H"	SHIP WGT
63"H Post, Dolly Base Unit		
MD1836CG46RE-5	18" x 36" x 70"	102 lbs
MD1848CG46RE-5	18" x 48" x 70"	116 lbs
MD1860CG46RE-5	18" x 60" x 70"	147 lbs
MD2436CG46RE-5	24" x 36" x 70"	132 lbs
MD2448CG46RE-5	24" x 48" x 70"	145 lbs
MD2460CG46RE-5	24" x 60" x 70"	175 lbs
74"H Post, Dolly Base Unit		
MD1836CG47RE-5	18" x 36" x 81"	108 lbs
MD1848CG47RE-5	18" x 48" x 81"	126 lbs
MD1860CG47RE-5	18" x 60" x 81"	143 lbs
MD2436CG47RE-5	24" x 36" x 81"	127 lbs
MD2448CG47RE-5	24" x 48" x 81"	153 lbs
MD2460CG47RE-5	24" x 60" x 81"	183 lbs

Rods & Tabs

Rods & tabs represent an economical, alternate solution for enclosure on backs and sides of mobile and stationary units.

Each kit includes:

- 3 - rods
- 9 - front/back tabs
- 9 - side/solid shelf tabs

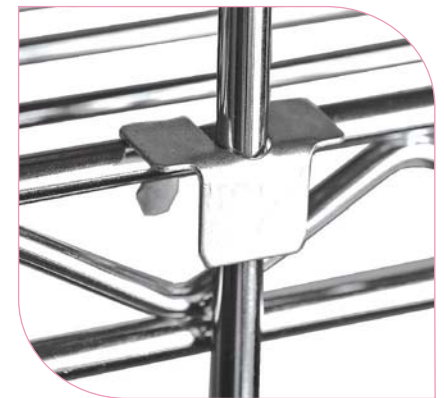

MODEL NO.	DESCRIPTION	SHIP WGT
Rods & Tabs		
52RT	3 - 52" Rods with tabs	1 lb
61RT	3 - 61" Rods with tabs	1 lb
72RT	3 - 72" Rods with tabs	2 lbs
84RT	3 - 84" Rods with tabs	2 lbs

Linen Carts

**COMPLETE CARTS
INCLUDE
caster kit for mobility!**



CART COVERS
Protect against pilferage, airborne dust, water and other contaminants!



WRCS4-63-2460EP



**NYLON FABRIC
OR CLEAR VINYL
CART COVERS
AVAILABLE!**
See pg. 61



WRDBS4-63-2460EP

**3 SIDED STEM CASTER LINEN CART
WITH 3 WIRE SHELVES AND 1 SOLID SHELF
WITH ENCLOSURE PANELS**

MODEL NO.	DIMENSIONS W" x L" x H"	SHIP WGT
63"H Post, 5" Stem Caster Unit with Solid Bottom Shelf and Enclosure Panels		
WRCS4-63-2436EP	24" x 36" x 69"	113 lbs
WRCS4-63-2448EP	24" x 48" x 69"	131 lbs
WRCS4-63-2460EP	24" x 60" x 69"	158 lbs
74"H Post, 5" Stem Caster Unit with Solid Bottom Shelf and Enclosure Panels		
WRCS4-74-2436EP	24" x 36" x 80"	113 lbs
WRCS4-74-2448EP	24" x 48" x 80"	131 lbs
WRCS4-74-2460EP	24" x 60" x 80"	158 lbs

All units consist of:

- 4 - posts
- 3 - wire shelves
- 1 - solid shelf
- 4 or 5 - enclosure panels

Mobile unit also includes:

- 4 - 5" swivel poly stem casters, 2 with brake
- 4 - donut bumpers

Dolly Base unit also includes:

- 1 - dolly base
- 4 - plate casters, 2 rigid and 2 swivel with brake

**3 SIDED DOLLY BASE LINEN CART
WITH 3 WIRE SHELVES AND 1 SOLID SHELF
WITH ENCLOSURE PANELS**

MODEL NO.	DIMENSIONS W" x L" x H"	SHIP WGT
63"H Post, Dolly Base Cart with Solid Bottom Shelf and Enclosure Panels		
WRDBS4-63-2436EP	24" x 36" x 70"	124 lbs
WRDBS4-63-2448EP	24" x 48" x 70"	142 lbs
WRDBS4-63-2460EP	24" x 60" x 70"	169 lbs
74"H Post, Dolly Base Cart with Solid Bottom Shelf and Enclosure Panels		
WRDBS4-74-2436EP	24" x 36" x 81"	124 lbs
WRDBS4-74-2448EP	24" x 48" x 81"	142 lbs
WRDBS4-74-2460EP	24" x 60" x 81"	169 lbs



CART COVERS
Protect against pilferage, airborne dust, water and other contaminants!

**COMPLETE CARTS
INCLUDE
caster kit for mobility!**



WRCS4-63-2460EP-5



**NYLON FABRIC
OR CLEAR VINYL
CART COVERS
AVAILABLE!**

See pg. 61



WRDBS4-63-2460EP-5

**3 SIDED STEM CASTER LINEN CART
WITH 4 WIRE SHELVES AND 1 SOLID SHELF
WITH ENCLOSURE PANELS**

MODEL NO.	DIMENSIONS W" x L" x H"	SHIP WGT
63"H Post, 5" Stem Caster Unit with Solid Bottom Shelf and Enclosure Panels		
WRCS4-63-2436EP-5	24" x 36" x 69"	126 lbs
WRCS4-63-2448EP-5	24" x 48" x 69"	147 lbs
WRCS4-63-2460EP-5	24" x 60" x 69"	179 lbs
74"H Post, 5" Stem Caster Unit with Solid Bottom Shelf and Enclosure Panels		
WRCS4-74-2436EP-5	24" x 36" x 80"	126 lbs
WRCS4-74-2448EP-5	24" x 48" x 80"	147 lbs
WRCS4-74-2460EP-5	24" x 60" x 80"	179 lbs

All units consist of:

- 4 - posts
- 4 - wire shelves
- 1 - solid shelf
- 4 or 5 - enclosure panels

Mobile unit also includes:

- 4 - 5" swivel poly stem casters, 2 with brake
- 4 - donut bumpers

Dolly Base unit also includes:

- 1 - dolly base
- 4 - plate casters, 2 rigid and 2 swivel with brake

**3 SIDED DOLLY BASE LINEN CART
WITH 4 WIRE SHELVES AND 1 SOLID SHELF
WITH ENCLOSURE PANELS**

MODEL NO.	DIMENSIONS W" x L" x H"	SHIP WGT
63"H Post, Dolly Base Cart with Solid Bottom Shelf and Enclosure Panels		
WRDBS4-63-2436EP-5	24" x 36" x 70"	137 lbs
WRDBS4-63-2448EP-5	24" x 48" x 70"	158 lbs
WRDBS4-63-2460EP-5	24" x 60" x 70"	190 lbs
74"H Post, Dolly Base Cart with Solid Bottom Shelf and Enclosure Panels		
WRDBS4-74-2436EP-5	24" x 36" x 81"	137 lbs
WRDBS4-74-2448EP-5	24" x 48" x 81"	158 lbs
WRDBS4-74-2460EP-5	24" x 60" x 81"	190 lbs

Security Units

Stationary and Mobile Units prevent pilferage while allowing high visibility of contents at all times. All side and back panels are heavy gauge wire construction and are manufactured of all-welded heavy-duty 1/4" diameter wire on 2" x 2" centers. Assembly is quick and easy. **Finish:** Chrome

Want to **SECURE** your existing shelving unit?

Security Panel Doors

Each door set has left and right panel with 4 hinge bars. Assembly is quick and easy and adapts to the appropriate shelf size, with our standard post of 63" in height.

MODEL NO.	DIMENSIONS W" x L" x H"	SHIP WGT
Security Panel Door Set with Hinges		
SD36C	24" x 36" x 60"	54 lbs
SD48C	24" x 48" x 60"	66 lbs
SD60C	24" x 60" x 60"	78 lbs

Security Panel Sets

Panels allow maximum security for standard shelving units. Panels are fabricated from all-welded wire and include joined back portion and two side portions.

MODEL NO.	DIMENSIONS W" x L" x H"	SHIP WGT
Security Enclosure Panel Set		
243660EPC	24" x 36" x 60"	70 lbs
244860EPC	24" x 48" x 60"	80 lbs
246060EPC	24" x 60" x 60"	90 lbs



2436-63SEC



M2436-69SEC



MD2436-70SEC

Stationary Security Units

Additional intermediate shelves can be purchased separately, see pg. 38. **Finish:** Chrome

- Each unit consists of:
- 4 - posts
 - 2 - wire shelves (for top and bottom)
 - 1 - security panel set (includes back and sides)
 - 1 - pair security panel doors

MODEL NO.	DIMENSIONS W" x L" x H"	SHIP WGT
Stationary Security Units		
2436-63SEC	24" x 36" x 63"	165 lbs
2448-63SEC	24" x 48" x 63"	192 lbs
2460-63SEC	24" x 60" x 63"	224 lbs

Stem Castered Security Units

Mobility adds flexibility to a unit and is beneficial in all types of operations. Additional intermediate shelves can be purchased separately, see pg. 38. **Finish:** Chrome

- Each unit consists of:
- 4 - posts
 - 2 - wire shelves (for top and bottom)
 - 1 - security panel set (includes back and sides)
 - 1 - pair security panel doors

- Mobile unit also includes:
- 4 - 5" poly stem casters, 2 with brake
 - 4 - donut bumpers

MODEL NO.	DIMENSIONS W" x L" x H"	SHIP WGT
Stem Castered Security Units		
M2436-69SEC	24" x 36" x 69"	173 lbs
M2448-69SEC	24" x 48" x 69"	200 lbs
M2460-69SEC	24" x 60" x 69"	232 lbs

Dolly Base Security Units

Dollies can add stability and support in heavy-duty load applications. Additional intermediate shelves can be purchased separately, see pg. 38. **Finish:** Chrome

- Each unit consists of:
- 4 - posts
 - 2 - wire shelves (for top and bottom)
 - 1 - security panel set (includes back and sides)
 - 1 - pair security panel doors

- Dolly Base unit also includes:
- 1 - dolly base
 - 4 - plate casters, 2 rigid and 2 swivel with brake

MODEL NO.	DIMENSIONS W" x L" x H"	SHIP WGT
Dolly Base Security Units		
MD2436-70SEC	24" x 36" x 70"	186 lbs
MD2448-70SEC	24" x 48" x 70"	215 lbs
MD2460-70SEC	24" x 60" x 70"	250 lbs

Cart Covers

Protect against pilferage, airborne dust, water and other contaminants. Velcro and zipper flap are available in clear-vinyl and blue and white denier nylon fabric. Clear vinyl is 10 gauge. Blue and white nylon fabric is 400 Denier. Specify zipper or velcro for closure. Custom sizes are available, call for more information.

TO ORDER:

- 1) Choose size
- 2) Select color: Clear Vinyl add suffix CV
Blue Nylon add suffix BN
White Nylon add suffix WN
- 3) Choose Zipper or Velcro

**COVERS PROTECT AGAINST
PILFERAGE, AIRBORNE
DUST, WATER
and other contaminants!**



CLEAR VINYL



BLUE NYLON



WHITE NYLON

63"H CART COVER				74"H CART COVER			
		400 DENIER	CLEAR VINYL			400 DENIER	CLEAR VINYL
DIMENSIONS	SHIP WGT	MODEL NO.	MODEL NO.	DIMENSIONS	SHIP WGT	MODEL NO.	MODEL NO.
18" x 36" x 63"	3 lbs	CC183663	CC183663CV	18" x 36" x 74"	4 lbs	CC183674	CC183674CV
18" x 48" x 63"	4 lbs	CC184863	CC184863CV	18" x 48" x 74"	5 lbs	CC184874	CC184874CV
18" x 60" x 63"	5 lbs	CC186063	CC186063CV	18" x 60" x 74"	6 lbs	CC186074	CC186074CV
18" x 72" x 63"	6 lbs	CC187263	CC187263CV	18" x 72" x 74"	7 lbs	CC187274	CC187274CV
24" x 36" x 63"	3 lbs	CC243663	CC243663CV	24" x 36" x 74"	4 lbs	CC243674	CC243674CV
24" x 48" x 63"	4 lbs	CC244863	CC244863CV	24" x 48" x 74"	5 lbs	CC244874	CC244874CV
24" x 60" x 63"	5 lbs	CC246063	CC246063CV	24" x 60" x 74"	6 lbs	CC246074	CC246074CV
24" x 72" x 63"	6 lbs	CC247263	CC247263CV	24" x 72" x 74"	7 lbs	CC247274	CC247274CV

Work Station Carts - *the ideal work-in-process cart!*

The sloped shelves allow for high visibility, productive rotations & gravity feed. **Cart Finish:** Chrome

Each unit consists of:

- 2 - 34" posts
- 2 - 27" posts
- 1 - flat wire shelf
- 1 - slanted wire shelf
- 4 - 5" swivel poly stem casters, 2 with brake
- 4 - donut bumpers

MOBILE MODEL NO.	SHELF DIMENSIONS W" x L"	NO. OF SHELVES	SHIP WGT
Work Station Carts - 40"H			
M1836SL34C	18" x 36"	2	35 lbs
M1848SL34C	18" x 48"	2	40 lbs
M2436SL34C	24" x 36"	2	42 lbs
M2448SL34C	24" x 48"	2	46 lbs



M1836SL34C

M1836SL34C
Shown with bins
(Bins are sold separately)

Slanted Shelf Carts - *Stationary and Mobile*

Stationary and Mobile Slanted Shelf units create a unique combination of modular components to enhance supply distribution applications. The sloped shelves allow for high visibility, productive rotations & gravity feed. Ideal for Par Level Systems. (Note: Build a system with your bin requirements or consult a product specialist for appropriate components)

Each unit consists of:

- 4 - 63" posts
- 2 - flat wire shelves
- 3 - slanted wire shelves

Each mobile unit consists of:

- 4 - 63" posts
- 2 - flat wire shelves
- 3 - slanted wire shelves
- 4 - 5" swivel poly stem casters, 2 with brake
- 4 - donut bumpers



MOBILIZE YOUR WIRE SHELVING

DB - Donut Bumper
Non-marking donut bumper used to protect walls and help cushion impact.

WR-00H (Mobile Kit)*
Set of four swivel polyurethane 5" x 1-1/4" casters, two with brakes. Can be used with all units shown. 1,200 lb. load capacity. *Mobile kits recommended only for shelves 18" and wider.

COMPLETE PACKAGES
with bins!

SLANTED SHELVING UNITS - 63"H						
			STATIONARY		MOBILE	
SHELF DIMENSIONS W" x L"	NO. OF SHELVES	MODEL NO.	SHIP WGT	MODEL NO.	SHIP WGT	
18" x 36"	5	1836SL6C	54 lbs	M1836SL6C	62 lbs	
18" x 48"	5	1848SL6C	65 lbs	M1848SL6C	73 lbs	
24" x 36"	5	2436SL6C	78 lbs	M2436SL6C	86 lbs	
24" x 48"	5	2448SL6C	90 lbs	M2448SL6C	98 lbs	

STATIONARY							MOBILE						
NO. OF BINS	BIN DIMENSIONS L" x W" x H"	NO. OF SHELVES	MODEL NO.	SHIP WGT	MODEL NO.	SHIP WGT							
18"W x 36"L x 63"H Slanted Wire Shelving With Dividable Grid Containers 2 Horizontal Shelves and 3 Slanted Shelves													
12 DG92035	16-1/2" x 10-7/8" x 3-1/2"	5	WRS-5-92035	128 lbs	MWRS-5-92035	136 lbs							
12 DG92060	16-1/2" x 10-7/8" x 6"	5	WRS-5-92060	135 lbs	MWRS-5-92060	143 lbs							
12 DG92080	16-1/2" x 10-7/8" x 8"	5	WRS-5-92080	145 lbs	MWRS-5-92080	153 lbs							
18"W x 36"L x 74"H Slanted Wire Shelving With Economy Shelf Bins 2 Horizontal Shelves and 5 Slanted Shelves													
48 QSB103	17-7/8" x 4-1/8" x 4"	7	WRS-7-103	153 lbs	MWRS-7-103	161 lbs							
30 QSB104	17-7/8" x 6-5/8" x 4"	7	WRS-7-104	146 lbs	MWRS-7-104	154 lbs							
24 QSB108	17-7/8" x 8-3/8" x 4"	7	WRS-7-108	143 lbs	MWRS-7-108	151 lbs							
18 QSB110	17-7/8" x 11-1/8" x 4"	7	WRS-7-110	144 lbs	MWRS-7-110	152 lbs							
18"W x 36"L x 74"H Slanted Wire Shelving With Euro Drawers 2 Horizontal Shelves and 5 Slanted Shelves													
54 QED604	17-5/8" x 3-3/4" x 4-5/8"	7	WRS-7-604	182 lbs	MWRS-7-604	190 lbs							
36 QED602	17-5/8" x 5-9/16" x 4-5/8"	7	WRS-7-602	169 lbs	MWRS-7-602	177 lbs							
24 QED606	17-5/8" x 8-3/8" x 4-5/8"	7	WRS-7-606	159 lbs	MWRS-7-606	167 lbs							



MWRS-5-92060

MWRS-7-104

**QUANTUM
HAS A NEW
ANGLE FOR
STORAGE!**



WRCSL5-74-1836-104230

Slanted Shelf with Bin Holders Combo Carts

A systems cart that offers hanging bins, slanted bins and bins on a flat surface all in one unit. Cart offer multiple applications the ability to store pre-packed items such as sutures or sloped storage for dispensing small parts. This combination creates a highly customized exchange and storage system. Bins available in Blue, Green, Ivory, Red, Yellow, Black and Clear. **Cart Finish:** Chrome

Available in: ● Blue ● Green ● Ivory ● Red ● Yellow ● Black ● Clear

MODEL NO.	NO. OF SHELVES	NO. OF BINS	BIN DIMENSIONS L" x W" x H"	SHIP WGT
18" x 36" x 80" Slanted Wire Shelf Cart with Bin Holders and Bins				
WRCSL5-74-1836-104220	5	20 QSB104 24 QUS220	17-7/8" x 6-5/8" x 4" 7-3/8" x 4-1/8" x 3"	105 lbs
WRCSL5-74-1836-104230	5	20 QSB104 18 QUS230	17-7/8" x 6-5/8" x 4" 10-7/8" x 5-1/2" x 5"	112 lbs
18" x 48" x 80" Slanted Wire Shelf Cart with Bin Holders and Bins				
WRCSL5-74-1848-104220	5	24 QSB104 30 QUS220	17-7/8" x 6-5/8" x 4" 7-3/8" x 4-1/8" x 3"	128 lbs

**COMPLETE PACKAGES
with bins!**



MOBILIZE YOUR WIRE SHELVING

DB - Donut Bumper

Non-marking donut bumper used to protect walls and help cushion impact.

WR-00H (Mobile Kit)*

Set of four swivel polyurethane 5" x 1-1/4" casters, two with brakes. Can be used with all units shown. 1,200 lb. load capacity. *Mobile kits recommended only for shelves 18" and wider.



WRCSL5-63-1836-104



WRCSL5-63-1836EP

Slanted Shelf Suture Carts - Open or Enclosed

Units are designed for quick and easy accessibility for pre-packed items such as sutures. The wire end panel maintains product while the slanted shelf allows for gravity feed. Available with or without side enclosures. Bins available in Blue, Green, Ivory, Red, Yellow, Black and Clear. **Cart Finish:** Chrome

OPEN		ENCLOSED	
MODEL NO.	SHIP WGT	MODEL NO.	SHIP WGT
5 Shelf, Slanted Suture Cart 2 Flat Shelves and 3 Slanted Shelves			
WRCSL5-63-1836	77 lbs	WRCSL5-63-1836EP	92 lbs
WRCSL5-63-1848	91 lbs	WRCSL5-63-1848EP	106 lbs
WRCSL5-63-2436	92 lbs	WRCSL5-63-2436EP	108 lbs
WRCSL5-63-2448	104 lbs	WRCSL5-63-2448EP	120 lbs

Available in: ● Blue ● Green ● Ivory ● Red ● Yellow ● Black ● Clear

**Dividers, Bin Cups and
Clear Label Holders**
See pg. 108

OPEN		ENCLOSED	
NO. OF BINS	BIN DIMENSIONS L" x W" x H"	MODEL NO.	SHIP WGT
5 Shelf, Slanted Suture Cart with Bins 2 Flat Shelves and 3 Slanted Shelves			
20 QSB104	17-7/8" x 6-5/8" x 4"	WRCSL5-63-1836-104	94 lbs
28 QSB104	17-7/8" x 6-5/8" x 4"	WRCSL5-63-1848-104	114 lbs
20 QSB106	23-5/8" x 6-5/8" x 4"	WRCSL5-63-2436-106	115 lbs
28 QSB106	23-5/8" x 6-5/8" x 4"	WRCSL5-63-2448-106	136 lbs
		WRCSL5-63-1836EP-104	103 lbs
		WRCSL5-63-1848EP-104	123 lbs
		WRCSL5-63-2436EP-106	131 lbs
		WRCSL5-63-2448EP-106	152 lbs



MOBILIZE YOUR WIRE SHELVING

DB - Donut Bumper

Non-marking donut bumper used to protect walls and help cushion impact.

WR-00H (Mobile Kit)*

Set of four swivel polyurethane 5" x 1-1/4" casters, two with brakes. Can be used with all units shown. 1,200 lb. load capacity. *Mobile kits recommended only for shelves 18" and wider.

600-800 lb.
capacity per shelf!



WR74-2448-66106 + WR-00H + 4 DB

High Density Wire Systems

- Wire Storage Systems with bins available in 48", 60" and 72" lengths
- All units in chart below utilize 74" posts and include 12 shelves
- Non-marring caster kit **WR-00H** sold separately
- Bins are available in Blue, Green, Ivory, Red, Yellow, Black and Clear

Available in: ● Blue ● Green ● Ivory ● Red ● Yellow ● Black ● Clear

HIGH DENSITY WIRE SYSTEMS									
48"L SYSTEMS				60"L SYSTEMS			72"L SYSTEMS		
BIN DIMENSIONS L" x W" x H"	MODEL NO.	NO. OF BINS	SHIP WGT	MODEL NO.	NO. OF BINS	SHIP WGT	MODEL NO.	NO. OF BINS	SHIP WGT
12"W x 48"L x 74"H Units				12"W x 60"L x 74"H Units			12"W x 72"L x 74"H Units		
11-5/8" x 4-1/8" x 4"	WR74-1248-110101	110 QSB101	152 lbs	WR74-1260-143101	143 QSB101	208 lbs	WR74-1272-176101	176 QSB101	248 lbs
11-5/8" x 4-1/8" x 4"	WR74-1248-101102	55 QSB101	148 lbs	WR74-1260-101102	78 QSB101	213 lbs	WR74-1272-101102	80 QSB101	240 lbs
11-5/8" x 6-5/8" x 4"		36 QSB102			40 QSB102			60 QSB102	
11-5/8" x 6-5/8" x 4"	WR74-1248-66102	66 QSB102	140 lbs	WR74-1260-88102	88 QSB102	193 lbs	WR74-1272-110102	110 QSB102	230 lbs
18"W x 48"L x 74"H Units				18"W x 60"L x 74"H Units			18"W x 72"L x 74"H Units		
17-7/8" x 4-1/8" x 4"	WR74-1848-110103	110 QSB103	168 lbs	WR74-1860-143103	143 QSB103	224 lbs	WR74-1872-176103	176 QSB103	264 lbs
17-7/8" x 4-1/8" x 4"	WR74-1848-103104	55 QSB103	164 lbs	WR74-1860-103104	78 QSB103	229 lbs	WR74-1872-103104	80 QSB103	256 lbs
17-7/8" x 6-5/8" x 4"		36 QSB104			40 QSB104			60 QSB104	
17-7/8" x 6-5/8" x 4"	WR74-1848-66104	66 QSB104	156 lbs	WR74-1860-88104	88 QSB104	209 lbs	WR74-1872-110104	110 QSB104	246 lbs
24"W x 48"L x 74"H Units				24"W x 60"L x 74"H Units			24"W x 72"L x 74"H Units		
23-5/8" x 4-1/8" x 4"	WR74-2448-110105	110 QSB105	180 lbs	WR74-2460-143105	143 QSB105	256 lbs	WR74-2472-176105	176 QSB105	312 lbs
23-5/8" x 4-1/8" x 4"	WR74-2448-105106	55 QSB105	176 lbs	WR74-2460-105106	78 QSB105	261 lbs	WR74-2472-105106	80 QSB105	304 lbs
23-5/8" x 6-5/8" x 4"		36 QSB106			40 QSB106			60 QSB106	
23-5/8" x 6-5/8" x 4"	WR74-2448-66106	66 QSB106	168 lbs	WR74-2460-88106	88 QSB106	241 lbs	WR74-2472-110106	110 QSB106	294 lbs

48"L - 800 lb. Capacity/Shelf

60"L - 600 lb. Capacity/Shelf

72"L - 600 lb. Capacity/Shelf



WRC9-63-2448-105

Catheter Cart - Complete with Bins

Uniquely designed, the catheter bin cart replaces the wire basket concept with color coded bins allowing for quicker identification. The combination of modular wire and plastic bins minimizes shrinkage and reduces unit cost. Bins are molded from high density polypropylene and are available in Blue, Green, Ivory, Red, Yellow, Black and Clear. **Cart Finish: Chrome**

Available in: ● Blue ● Green ● Ivory ● Red ● Yellow ● Black ● Clear

MODEL NO.	BIN DIMENSIONS L" x W" x H"	SHIP WGT
24" x 48" x 69" Wire Catheter Cart with 9 Wire Shelves Complete with 80 QSB105 Bins		
WRC9-63-2448-105	23-5/8" x 4-1/8" x 4"	246 lbs

COMPLETE PACKAGE
with bins!



Catheter Hooks

Package includes 6 catheter hooks.
Finish: Chrome

MODEL NO.	DESCRIPTION	CTN WGT
Catheter Hooks - 6 Pack		
WR-CH	6 Catheter Hooks	2 lbs

Catheter Hold and Store Cart

The catheter hold and store cart allows separation and easy accessibility to pre-packed catheters. Ideal for central or OR supply centers, this style cart is modular in design. Includes 32 catheter hooks. **Finish: Chrome**

MODEL NO.	DIMENSIONS W" x L" x H"	SHIP WGT
Catheter Hold & Store Cart Includes 32 Catheter Hooks		
WRC-BC2448	24" x 48" x 69"	105 lbs



WRC-BC2448

Shown with Dividable Grid Containers
Sold separately on pg. 117

Bin Cart Systems

Bin cart can be used for transporting and holding product. A modular drawer system allows for storage of smaller specialty components while the open shelf design maximizes the storage area. The option of cart covers pg. 61, enclosure panels pg. 76, ledges and dividers pg. 77 add to the flexibility of the unit. Dividable grids are available in Blue, Red, Gray and Clear. **Cart Finish:** Chrome

Available in: ● Blue ● Red ● Gray ● Clear

MODEL NO.	NO. OF BINS	BIN DIMENSIONS L" x W" x H"	SHIP WGT
24"W x 36"L x 69"H Bin Cart with Dividable Grids			
WRC5-63-2436-93060	4 DG93060	22-1/2" x 17-1/2" x 6"	113 lbs
24"W x 48"L x 69"H Bin Cart with Dividable Grids			
WRC5-63-2448-93060	4 DG93060	22-1/2" x 17-1/2" x 6"	128 lbs
24"W x 60"L x 69"H Bin Cart with Dividable Grids			
WRC5-63-2460-93060	4 DG93060	22-1/2" x 17-1/2" x 6"	153 lbs

COMPLETE PACKAGES with bins!



CLEAR BINS VIEW

Single Bay Bin Carts

Offering two heights and four bin quantity designs, these modular carts are the ultimate work-in-process and transport cart. Dividable grids slide easily in and out and with their ability to be divided into multiple compartments with long and short dividers, truly any type of storage is possible, see pg. 117 for dividers and label holders. Dividable grids are available in Blue, Red, Gray and Clear. **Cart Finish:** Chrome

Available in: ● Blue ● Red ● Gray ● Clear

MODEL NO.	NO. OF BINS	BIN DIMENSIONS L" x W" x H"	SHIP WGT
21"W x 24"L x 45"H Bin Cart with Dividable Grid Containers			
BC212434M1	4 DG93060	22-1/2" x 17-1/2" x 6"	58 lbs
BC212439M2	7 DG93030	22-1/2" x 17-1/2" x 3"	79 lbs
21"W x 24"L x 69"H Bin Cart with Dividable Grid Containers			
BC212469M1	7 DG93060	22-1/2" x 17-1/2" x 6"	107 lbs
BC212469M2	11 DG93030	22-1/2" x 17-1/2" x 3"	111 lbs
21"W x 24"L x 45"H Bin Cart with No Dividable Grid Containers			
BC212439M4	No containers (includes slides for 4 bin levels)		46 lbs
BC212439M7	No containers (includes slides for 7 bin levels)		55 lbs
21"W x 24"L x 69"H Bin Cart with No Dividable Grid Containers			
BC212469M	No containers (includes slides for 7 bin levels)		63 lbs
BC212469M11	No containers (includes slides for 11 bin levels)		75 lbs
WR-524W	One Pair - 24" Wire Bin Slides	--	3 lbs



WRC5-63-2436-93060

- Each unit consists of:
- 4 - 63" posts
 - 5 - wire shelves
 - 4 - DS18-24 bin slides
 - 4 - 5" swivel poly stem casters, 2 with brake
 - 4 - donut bumpers
 - 4 - DG93060 bins (Blue, Red, Gray and Clear)



BC212434M1



BC212469M1

Dividers and Clear Label Holders
See pg. 117

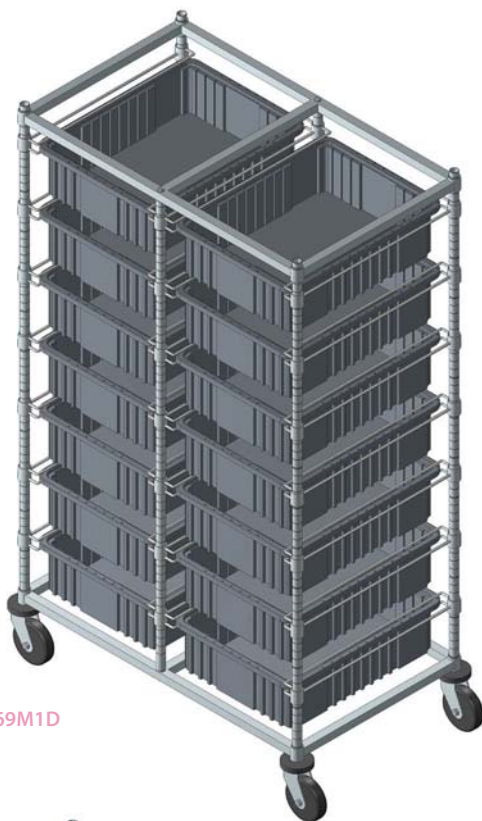

BC214069M1D



BC216069M1T

Double & Triple Bay Bin Carts

Offering two heights and eight bin quantity designs, these modular carts are the ultimate work-in-process and transport cart. Dividable grids slide easily in and out and with their ability to be divided into multiple compartments with long and short dividers, truly any type of storage is possible, see pg. 117 for dividers and label holders. Dividable grids are available in Blue, Red, Gray and Clear. **Cart Finish:** Chrome

Double Bay Bin Carts

Available in: ● Blue ● Red ● Gray ● Clear

MODEL NO.	NO. OF BINS	BIN DIMENSIONS L" x W" x H"	SHIP WGT
21"W x 40"L x 45"H Bin Cart with Dividable Grid Containers			
BC214045M1D	8 DG93060	22-1/2" x 17-1/2" x 6"	101 lbs
BC214045M2D	14 DG93030	22-1/2" x 17-1/2" x 3"	116 lbs
21"W x 40"L x 69"H Bin Cart with Dividable Grid Containers			
BC214069M1D	14 DG93060	22-1/2" x 17-1/2" x 6"	163 lbs
BC214069M2D	22 DG93030	22-1/2" x 17-1/2" x 3"	164 lbs
21"W x 40"L x 45"H Bin Cart with No Dividable Grid Containers			
BC214045M8D	No containers (includes slides for 8 bin levels)		51 lbs
BC214045M14D	No containers (includes slides for 14 bin levels)		69 lbs
21"W x 40"L x 69"H Bin Cart with No Dividable Grid Containers			
BC214069M14D	No containers (includes slides for 14 bin levels)		75 lbs
BC214069M22D	No containers (includes slides for 22 bin levels)		91 lbs
One Pair - 24" Wire Single Bin Slides			
WR-S24W	--	--	3 lbs
One - 24" Wire Double Bin Slides			
WR-D24W	--	--	2 lbs

COMPLETE PACKAGES with bins!

Dividers & Accessories
Containers can be divided by length and/or width allowing a subdivision down to a 1-1/8" square compartment size. Available in Gray.

AVAILABLE
See pg. 117



Triple Bay Bin Carts

Available in: ● Blue ● Red ● Gray ● Clear

MODEL NO.	NO. OF BINS	BIN DIMENSIONS L" x W" x H"	SHIP WGT
21"W x 60"L x 45"H Bin Cart with Dividable Grid Containers			
BC216045M1T	12 DG93060	22-1/2" x 17-1/2" x 6"	142 lbs
BC216045M2T	21 DG93030	22-1/2" x 17-1/2" x 3"	154 lbs
21"W x 60"L x 69"H Bin Cart with Dividable Grid Containers			
BC216069M1T	21 DG93060	22-1/2" x 17-1/2" x 6"	233 lbs
BC216069M2T	33 DG93030	22-1/2" x 17-1/2" x 3"	234 lbs
21"W x 60"L x 45"H Bin Cart with No Dividable Grid Containers			
BC216045M12T	No containers (includes slides for 12 bin levels)		66 lbs
BC216045M21T	No containers (includes slides for 21 bin levels)		84 lbs
21"W x 60"L x 69"H Bin Cart with No Dividable Grid Containers			
BC216069M21T	No containers (includes slides for 21 bin levels)		100 lbs
BC216069M33T	No containers (includes slides for 33 bin levels)		124 lbs
One Pair - 24" Wire Single Bin Slides			
WR-S24W	--	--	3 lbs
One - 24" Wire Double Bin Slides			
WR-D24W	--	--	2 lbs



High Density Sliding Track System



High Density Sliding Track System offers a unique way to maximize and efficiently move wire shelving systems. The patented design allows for quick and easy installation. Bearings in the skate are located under each post for a load capacity of 1,500 lbs. per shelving unit. The v-groove floor track allows the shelving unit to slide back and forth with ease. Layout assistance is available.

PERFORMANCE FEATURES AND BENEFITS

- Cuts construction costs
- Low shipping cost
- NSF approved
- Uses industrial bearings
- Corrosion free construction
- Easy to roll construction
- Fast installation
- Utilizes the structure of existing shelving
- Complies with ADA regulations
- 1,500 lb. load capacity per unit
- Can increase storage areas up to 150%



UNITS SLIDE BACK AND FORTH WITH EASE!



Heavy-duty track systems available to accommodate IV solutions, formula and instrument containers. Call a product specialist for details

STEP BY STEP ORDERING INSTRUCTIONS:

- (Note: Shelves and posts to be purchased separately on pg. 38-39)
- Step 1 - Select desired length (in inches) of track. Use (QVTRK) to order track.
(Note: single units require two tracks and double units will require three tracks)
- Step 2 - Select corresponding skate size from the chart, which will be the same as the depth of shelving unit to be utilized. Two skates required per single unit and three skates required per double unit.
(Note: post height should not exceed a 4 to 1 ratio of skate size)
- Step 3 - Purchase one End Stop Kit (QESTP) per track length.
- For each double unit being used, a Wing Kit (WK) is required.

MODEL NO.	DESCRIPTION	SHIP WGT
Sliding Track Skates		
HD18	One 18" Skate	4 lbs
HD21	One 21" Skate	5 lbs
HD24	One 24" Skate	6 lbs
HD30	One 30" Skate	7 lbs
HD36	One 36" Skate	8 lbs
Additional Components		
QESTP	End Stop Kit	1 lb
QVTRK	V-Track (Sold per inch)	1 lb
WK	Wing Kit	2 lbs

WK
Wing Kit

Includes four 1/4" thick plates & hardware and allows for the joining of 2 units side by side, sharing one track.



HD18 - HD36
One Skate

QESTP
End Stop Kit

Includes 2 ends and 1 drill bit. Serves the dual purpose of stopping a skate and is the anchor for the track. One kit is required per track.



QVTRK
V-Groove Track
(Sold by the inch)

SINGLE UNIT TRACK SYSTEM (Top View)

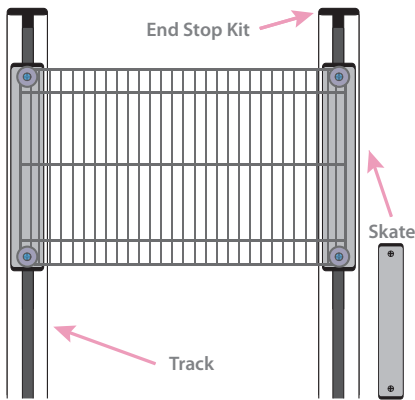

DOUBLE UNIT TRACK SYSTEM (Top View)

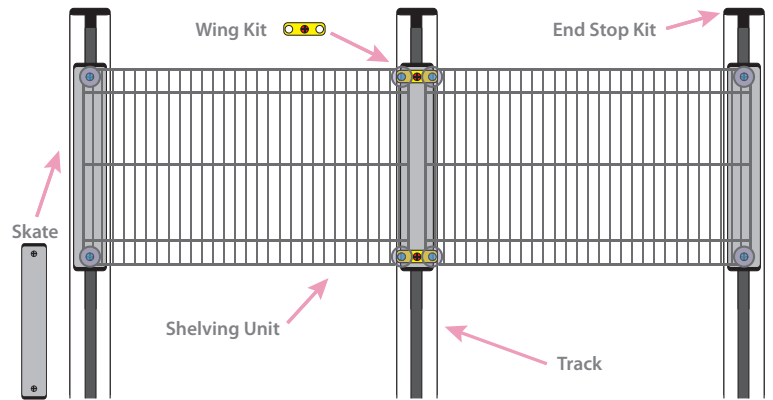

Single Unit Floor Track Assemblies



Assembly kit consists of a pair of aluminum tracks with end stop kits. Hardware and assembly instructions included. (Note: custom lengths may be purchased, see pg. 68)

MODEL NO.	TRACK L' (FT)	TRACK L" (IN)	SHIP WGT
Single Unit Floor Track Assembly Kit Includes 2 Tracks of Specified Length with End Stop Kits			
QVTRK-2-72EST	6'	72"	14 lbs
QVTRK-2-84EST	7'	84"	16 lbs
QVTRK-2-96EST	8'	96"	18 lbs
QVTRK-2-108EST	9'	108"	20 lbs
QVTRK-2-120EST	10'	120"	22 lbs
QVTRK-2-132EST	11'	132"	24 lbs
QVTRK-2-144EST	12'	144"	26 lbs
QVTRK-2-156EST	13'	156"	28 lbs
QVTRK-2-168EST	14'	168"	30 lbs
QVTRK-2-180EST	15'	180"	32 lbs
QVTRK-2-192EST	16'	192"	34 lbs
QVTRK-2-204EST	17'	204"	36 lbs
QVTRK-2-216EST	18'	216"	38 lbs
QVTRK-2-228EST	19'	228"	40 lbs
QVTRK-2-240EST	20'	240"	42 lbs

Single Unit Skate Assembly Kits



Each kit includes two skates and all appropriate hardware. One kit is required for each single mobile unit. (Shelves and posts sold separately on pg. 38 and 39)

MODEL NO.	DESCRIPTION	SHIP WGT
Single Unit Skate Assembly Kits		
HD18-2	Two 18" Skates	8 lbs
HD21-2	Two 21" Skates	10 lbs
HD24-2	Two 24" Skates	12 lbs
HD30-2	Two 30" Skates	14 lbs
HD36-2	Two 36" Skates	16 lbs

Double Unit Floor Track Assemblies



Each assembly kit consists of three aluminum tracks with end stop kits. Hardware and assembly instructions included. (Note: custom lengths may be purchased, see pg. 68)

MODEL NO.	TRACK L' (FT)	TRACK L" (IN)	SHIP WGT
Double Unit Floor Track Assembly Kit Includes 3 Tracks of Specified Length with End Stop Kits			
QVTRK-3-72EST	6'	72"	21 lbs
QVTRK-3-84EST	7'	84"	24 lbs
QVTRK-3-96EST	8'	96"	27 lbs
QVTRK-3-108EST	9'	108"	30 lbs
QVTRK-3-120EST	10'	120"	33 lbs
QVTRK-3-132EST	11'	132"	36 lbs
QVTRK-3-144EST	12'	144"	39 lbs
QVTRK-3-156EST	13'	156"	42 lbs
QVTRK-3-168EST	14'	168"	45 lbs
QVTRK-3-180EST	15'	180"	48 lbs
QVTRK-3-192EST	16'	192"	51 lbs
QVTRK-3-204EST	17'	204"	54 lbs
QVTRK-3-216EST	18'	216"	57 lbs
QVTRK-3-228EST	19'	228"	60 lbs
QVTRK-3-240EST	20'	240"	63 lbs

Double Unit Skate Assembly Kits



Each kit includes three skates and all appropriate hardware. One kit is required for each double mobile unit. (Shelves and posts sold separately on pg. 38 and 39)

MODEL NO.	DESCRIPTION	SHIP WGT
Double Unit Skate Assembly Kits		
HD18-3	Three 18" Skates + Wing Kit	15 lbs
HD21-3	Three 21" Skates + Wing Kit	18 lbs
HD24-3	Three 24" Skates + Wing Kit	21 lbs
HD30-3	Three 30" Skates + Wing Kit	24 lbs
HD36-3	Three 36" Skates + Wing Kit	27 lbs

ORDERING INSTRUCTIONS:

- Step 1 - Select desired length of track and if you require:
- Single Unit track (use charts on left)
 - Double Unit track (use charts on right)
- Step 2 - Select corresponding skate size from single or double unit charts below. Skate size should match the depth of shelving unit being utilized.
- Step 3 - Using the chart on the bottom of this page, determine how many shelving units will fit on your track.
- Step 4 - Pre-configured 4 and 5 Shelf wire units are available on pg. 40-43. Additional intermediate shelves are available on pg. 38.

QUANTITY OF SHELVING UNITS BY WIDTH TO FIT ON LENGTH OF TRACK*

	6'	7'	8'	9'	10'	11'	12'	13'	14'	15'	16'	17'	18'	19'	20'
18"	2	2	3	4	4	5	6	6	7	8	8	9	10	10	11
21"	1	2	2	3	4	4	5	5	6	6	7	8	8	9	9
24"	1	2	2	3	3	4	4	5	5	6	6	7	7	8	8
30"	1	1	2	2	2	3	3	4	4	4	5	5	6	6	6
36"	1	1	1	2	2	2	3	3	3	4	4	4	5	5	5

* Using a minimum 36" aisle space. Note, post height should not exceed the skate length by a 4 to 1 ration (example 18" skate should not exceed a 74" post)



TRACK ROLLER
Included with Mobile kit
(Set of 4)

Sliding Top Track System



Quantum's new Top Track wire shelving system provides maximum storage using a minimum of space. All kits include all necessary sections of track for assembling lengths that range from 8' to 21' (*note: shelves and posts sold separately*). Assembly is quick and easy and the whole system requires only single-aisle access. Casters are 5" x 1-1/4" rigid polyurethane. TopTrack design provides a clear walkway and clear aisles underneath eliminating any tripping hazard. Top track extrusion manufactured of heavy duty aluminum ensuring years of heavy duty and reliable service.

PERFORMANCE FEATURES AND BENEFITS

- NSF approved
- Uses industrial bearings
- Corrosion free construction
- Easy to roll construction
- Fast installation
- Utilizes the structure of existing shelving
- 1,200 lb. load capacity per unit
- Can increase storage areas up to 150%

MODEL NO.	DESCRIPTION	SHIP WGT
Top Track		
TK-2	One Track - 2 Feet	7 lbs
TK-26	One Track - 2-1/2 Feet	9 lbs
TK-5	One Track - 5 Feet	17 lbs
TK-6	One Track - 6 Feet	21 lbs
TK-7	One Track - 7 Feet	24 lbs
TK-EP	Track End Plates with Hardware (Set of 4)	1 lb
TK-CA	Track Connector with Hardware (Set of 4)	6 lbs
End Unit Single Sided Track Bracket Pair		
TK-STB18	18" Single Top Track Bracket Pair	4 lbs
TK-STB21	21" Single Top Track Bracket Pair	5 lbs
TK-STB24	24" Single Top Track Bracket Pair	6 lbs
Intermediate Unit Double Sided Track Bracket Pair		
TK-DTB18	18" Double Top Track Bracket Pair	4 lbs
TK-DTB21	21" Double Top Track Bracket Pair	5 lbs
TK-DTB24	24" Double Top Track Bracket Pair	6 lbs
Mobile Unit Track Rollers		
TK-CBW	Set of 4 Track Rollers	2 lbs



INCREASE STORAGE AREAS
up to 150%



STATIONARY END KIT
(Shelves sold separately)



INTERMEDIATE KIT
(Shelves sold separately)



MOBILE KIT
(Shelves sold separately)

ORDERING INSTRUCTIONS:

- Step 1 - Select desired length of track.
- Step 2 - Select corresponding stationary end kit and intermediate kits from charts. Size should match the depth of shelving unit being utilized.
- Step 3 - Using the chart on the bottom of this page, determine how many Mobile Kits will fit on your track.
- Step 4 - Wire shelves are available on pg. 38.

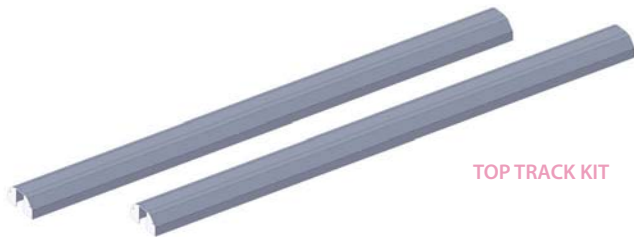

TOP TRACK KIT

Top Track Kits



Each kit includes two track of the same length and the plates.

MODEL NO.	TRACK L' (FT)	TRACK L' (IN)	SHIP WGT
Top Track Kit			
TTK-8	8'	96"	63 lbs
TTK-9	9'	108"	69 lbs
TTK-10	10'	120"	75 lbs
TTK-11	11'	132"	83 lbs
TTK-12	12'	144"	91 lbs
TTK-13	13'	156"	97 lbs
TTK-14	14'	168"	103 lbs
TTK-15	15'	180"	115 lbs
TTK-16	16'	192"	123 lbs
TTK-17	17'	204"	129 lbs
TTK-18	18'	216"	139 lbs
TTK-19	19'	228"	145 lbs
TTK-20	20'	240"	151 lbs
TTK-21	21'	252"	157 lbs

Stationary End Kits



Unit consists of:

- 8 - 86" Posts
- 8 - Foot plates
- 4 - Single sided top track support brackets

MODEL NO.	DESCRIPTION	SHIP WGT
TTK-E18	18" Stationary End Kits	50 lbs
TTK-E21	21" Stationary End Kits	52 lbs
TTK-E24	24" Stationary End Kits	54 lbs

Intermediate Kits



Unit consists of:

- 4 - 86" Posts
- 4 - Foot plates
- 2 - Double sided top track support brackets

MODEL NO.	DESCRIPTION	SHIP WGT
TTK-C18	18" Intermediate Kits	25 lbs
TTK-C21	21" Intermediate Kits	26 lbs
TTK-C24	24" Intermediate Kits	27 lbs

Mobile Kits



Unit consists of:

- 4 - 74" Posts
- 4 - Track rollers
- 2 - Tie bars
- 4 - Rigid casters
- 4 - Donut bumpers

MODEL NO.	DESCRIPTION	SHIP WGT
TTK-M18	18" Mobile Kit	34 lbs
TTK-M21	21" Mobile Kit	36 lbs
TTK-M24	24" Mobile Kit	38 lbs

QUANTITY OF SHELVING UNITS BY WIDTH TO FIT ON LENGTH OF TRACK*

	8'	9'	10'	11'	12'	13'	14'	15'	16'	17'	18'	19'	20'	21'
18"	3	4	4	5	6	6	7	8	8	9	10	10	11	11
21"	2	3	4	4	5	5	6	6	7	8	8	9	9	9
24"	2	3	3	4	4	5	5	6	6	7	7	8	8	8

* Using a minimum 36" aisle space.



1826TR



2026TRGY

Cafeteria Trays



Heavy-duty 18" x 26" white trays are NSF approved for use for food service or may be used for standard applications. Perimeter ends are reinforced for additional strength. 20" x 26" size offers a deep stacking tray. All trays are manufactured of fiberglass reinforced thermoset material, allowing up to 200 lbs. weight capacity when evenly distributed. Modular trays will withstand temperatures of -40°F to +250°F. 18" x 26" Trays available in White. 20" x 26" Trays are available in White and Gray.

Available in: ● White ● Gray

MODEL NO.	DIMENSIONS W" x L" x H"	SHIP WGT
18" x 26" Trays		
1826TR	18" x 26" x 1-1/8" White Tray	4 lbs
20" x 26" Trays		
2026TRGY	20" x 26" x 1-1/2" Gray Tray	5 lbs
2026TRWT	20" x 26" x 1-1/2" White Tray	5 lbs

Cafeteria Tray Carts

Tray Carts are offered in half size and full size units, designed to handle work in process and food distribution. Ideal for delivery of food to patient rooms. Optional tray stop prevents trays from sliding out of the unit both in front and/or behind. **Cart finish:** Chrome



TRAY STOPS

Can be used on back as shown here or one in the back and one in the front

TRAY STOP
AVAILABLE!

TS62C
(Sold separately)

200 lb.
capacity per tray!

MODEL NO.	DIMENSIONS W" x L" x H"	CAPACITY	SHIP WGT	TRAY STOP MODEL NO.
39"H Tray Cart				
TC-19	18" x 30" x 39"	19 Trays	45 lbs	TS32C
69"H Tray Carts				
TC-39	18" x 30" x 69"	39 Trays	74 lbs	TS62C
TC-31	21" x 30" x 69"	31 Trays	68 lbs	TS62C
69"H End Load Tray Carts				
TC-EL39	21-3/4" x 27" x 69"	38 Trays	74 lbs	TS62C

Trays are sold separately.



TC-39 + 1826TR
(Trays sold separately)



TC-19 + 1826TR
(Trays sold separately)



662412DPP



662412DPS

MODEL NO.	DIMENSIONS W" x L" x H"	SHIP WGT
Ventilated		
362412DPP	24" x 36" x 12"	13 lbs
363612DPP	36" x 36" x 12"	22 lbs
482412DPP	24" x 48" x 12"	19 lbs
662412DPP	24" x 66" x 12"	23 lbs
663612DPP	36" x 66" x 12"	37 lbs
962412DPP	24" x 96" x 12"	34 lbs
963612DPP	36" x 96" x 12"	53 lbs
Solid		
362412DPS	24" x 36" x 12"	17 lbs
363612DPS	36" x 36" x 12"	26 lbs
482412DPS	24" x 48" x 12"	21 lbs
662412DPS	24" x 66" x 12"	28 lbs
663612DPS	36" x 66" x 12"	49 lbs
962412DPS	24" x 96" x 12"	41 lbs
963612DPS	36" x 96" x 12"	64 lbs

Polymer Dunnage Rack



Our Dunnage-Rack is as portable as it is versatile. Made from lightweight, heavy-duty HDPE, these are the perfect match for wet, or chemically intense manufacturing environments. A simple snap-together design makes it a breeze to raise finished goods and raw materials off the ground and away from moisture, dirt and traffic. When it comes to cleanup time, just sweep underneath! We offer the largest commercially available sizes in a high-capacity, low-cost dunnage solution that lets you reset and move workstations as often as you see fit. Plus, the grid-top design simplifies working with fluids and bagged goods because any spilled items will flow through the surface to the floor below.



EASILY STORE SUPPLIES & MATERIALS off the ground!

Expandable EZ Lock Platform Rack & Pallet



Quantum's NEW EZ Lock platform and pallet allows you to customize your storage space in seconds. Its patented interlocking design allows true flexibility in building the exact size pallet or platform you need. Using 12" x 40" footprints, each unit locks together making this an all purpose storage, moving, and shipping solution. Manufactured of recycled high density polyethylene, the vented deck is freezer safe and chemical resistant. Its one piece body design and structure allows for a 4 way forklift and hand truck entry, and it meets GMA industry standards. Enhances any 5S Lean initiative. Withstands temperatures from -30° F – 200° F and offers a 2,500 lb load capacity. Once built, the structure will maintain its dimensions with no sagging or stretching. Plastic will not absorb any liquids or chemicals and is resistant to insect infestation. Perfect for use in hospitals, pharmacies, clean rooms, food and beverage areas, manufacturing environments, and supermarket and grocery store back rooms. **Color:** Black

new

MODEL NO.	DIMENSIONS W" x L" x H"	CTN QTY	SHIP WGT
EL-12406	12" x 40" x 6"	1 Pair (2 Pieces)	12 lbs



LOCKING SYSTEMS
Simple locking system allows for quick and trouble-free assembly



QUICK & TROUBLE-FREE ASSEMBLY!
2,500 lbs. load capacity!

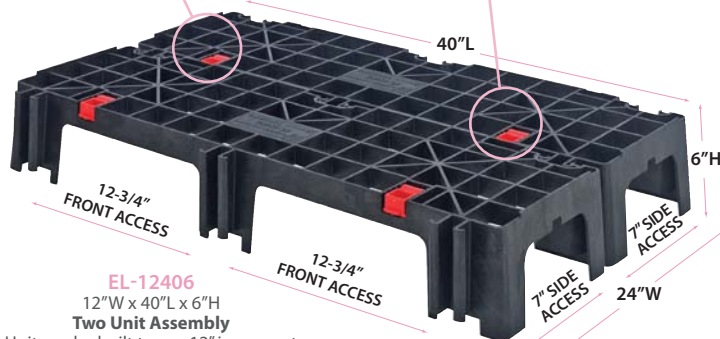

EL-12406
12"W x 40"L x 6"H
Two Unit Assembly
Unit can be built to any 12" increment to organize, ship, move or store items
(Sold in pairs, 2 pieces)



Mobile Dunnage Platform Rack



With 5" Poly non-marking stem casters add flexibility. Units can be used for moving case goods and other heavy items for cleaning, warehouse and stock room applications. **Finish:** Endurance

Each unit consists of:

- 4 - 6" posts
- 1 - 3 sided frame
- 1 - dunnage shelf
- 4 - 5" swivel poly stem casters, 2 with brake
- 4 - donut bumpers

ENDURANCE MODEL NO.	DIMENSIONS W" x L" x H"	SHIP WGT
M18366DE	18" x 36" x 12"	36 lbs
M18486DE	18" x 48" x 12"	44 lbs
M18606DE	18" x 60" x 12"	51 lbs
M24366DE	24" x 36" x 12"	40 lbs
M24486DE	24" x 48" x 12"	47 lbs
M24606DE	24" x 60" x 12"	55 lbs



M18366DE

Modular Dunnage Rack



Ideal for extreme load capacities (1,500 lb.). Includes tubular 1" square frame super structure and removable wire top mat. **Finish:** Endurance

Each unit consists of:

- 4 - 14" posts
- 1 - 3 sided frame
- 1 - dunnage shelf

ENDURANCE MODEL NO.	DIMENSIONS W" x L" x H"	SHIP WGT
183614DE	18" x 36" x 14"	28 lbs
184814DE	18" x 48" x 14"	36 lbs
186014DE	18" x 60" x 14"	43 lbs
243614DE	24" x 36" x 14"	32 lbs
244814DE	24" x 48" x 14"	39 lbs
246014DE	24" x 60" x 14"	47 lbs



183614DE

Tank & Beverage Container Rack



Represents a cost effective way to keep containers off the floor for cleanliness. This unit is an effective way to tidy up and increase available storage capacity. Used frequently in cafeterias and warehouse applications. **Finish:** Endurance

Each 1 Tier unit consists of:

- 4 - 34" posts
- 1 - 3 sided frame
- 1 - dunnage shelf

Each 2 Tier unit consists of:

- 4 - 54" posts
- 2 - 3 sided frames
- 2 - dunnage shelves

ENDURANCE MODEL NO.	DIMENSIONS W" x L" x H"	SHIP WGT
1 Tier		
183634DE	18" x 36" x 34"	40 lbs
184834DE	18" x 48" x 34"	48 lbs
186034DE	18" x 60" x 34"	55 lbs
243634DE	24" x 36" x 34"	44 lbs
244834DE	24" x 48" x 34"	51 lbs
246034DE	24" x 60" x 34"	59 lbs
2 Tier		
183654DE	18" x 36" x 54"	68 lbs
184854DE	18" x 48" x 54"	84 lbs
186054DE	18" x 60" x 54"	98 lbs
243654DE	24" x 36" x 54"	76 lbs
244854DE	24" x 48" x 54"	90 lbs
246054DE	24" x 60" x 54"	106 lbs



183654DE

Shelf Platform Rack



Represents an ergonomic solution for keeping case goods off the floor. Platforms are often used at workstations and prep storage areas. **Finish:** Chrome

Each unit consists of:

- 4 - 14" posts
- 1 - shelf

CHROME MODEL NO.	DIMENSIONS W" x L" x H"	SHIP WGT
183614PC	18" x 36" x 14"	14 lbs
184814PC	18" x 48" x 14"	18 lbs
186014PC	18" x 60" x 14"	21 lbs
243614PC	24" x 36" x 14"	17 lbs
244814PC	24" x 48" x 14"	20 lbs
246014PC	24" x 60" x 14"	25 lbs

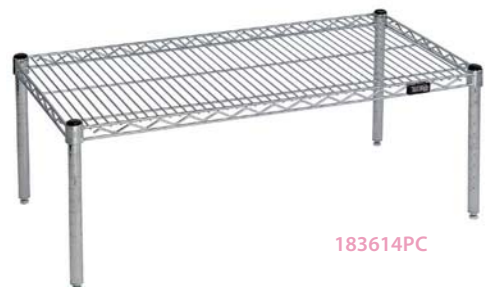

183614PC



1836DS

ENDURANCE MODEL NO.	DIMENSIONS W" x L"	SHIP WGT
1836DS	18" x 36"	21 lbs
1848DS	18" x 48"	28 lbs
1860DS	18" x 60"	34 lbs
2436DS	24" x 36"	24 lbs
2448DS	24" x 48"	30 lbs
2460DS	24" x 60"	37 lbs

Dunnage Shelf

Utilized in extreme load applications. Shelf is constructed of square tubing and a removable top wire grid. 1,500 lb. capacity. **Finish:** Endurance



2436SL

CHROME MODEL NO.	DIMENSIONS W" x L"	SHIP WGT	DIVIDER MODEL NO.
1836SL	18" x 36"	10 lbs	DIV18SL
1848SL	18" x 48"	12 lbs	DIV18SL
2436SL	24" x 36"	13 lbs	DIV24SL
2448SL	24" x 48"	15 lbs	DIV24SL

Slanted Shelf

Designed to add structure to various applications and retain products. **Finish:** Chrome



1836FE

ENDURANCE MODEL NO.	DIMENSIONS W" x L"	SHIP WGT
1836FE	18" x 36"	7 lbs
1848FE	18" x 48"	8 lbs
1860FE	18" x 60"	9 lbs
2436FE	24" x 36"	8 lbs
2448FE	24" x 48"	9 lbs
2460FE	24" x 60"	10 lbs

3 Sided Frame

Constructed of 1" square tubing, frame is designed for added structure to the perimeter of a dunnage or shelving unit. **Finish:** Endurance



2436FS

CHROME MODEL NO.	STAINLESS MODEL NO.	DIMENSIONS W" x L"	SHIP WGT
1836FC	1836FS	18" x 36"	6 lbs
1848FC	1848FS	18" x 48"	7 lbs
1860FC	1860FS	18" x 60"	8 lbs
2436FC	2436FS	24" x 36"	8 lbs
2448FC	2448FS	24" x 48"	9 lbs
2460FC	2460FS	24" x 60"	10 lbs

3 Sided Frame

Designed to add structure to various applications and retain products. **Finishes:** Chrome & 304 Stainless Steel



- Bin Rail Holder adjusts on 1" increments
- Bins sold separately

MODEL NO.	DESCRIPTION	SHIP WGT
36BH	One 36" Bin Holder	5 lbs
48BH	One 48" Bin Holder	7 lbs
60BH	One 60" Bin Holder	9 lbs

Bin Rail Holder

Creates a more functional work area with the bin rail which allows you to adapt bins to your shelving unit. **Finish:** Chrome



Modular Enclosure Panels

Are easily adaptable to standard shelving units to create a secured storage area.

- Panels are fabricated from 6 gauge wire on 3" x 3" squares
- Modular enclosure panels work with four shelf depths: 14", 18", 21" and 24" and three heights: 63", 74" and 86"
- One modular enclosure panel is needed for each side and two or three panels are needed for the back

CHROME		STAINLESS STEEL		
MODEL NO.	MODEL NO.	DESCRIPTION	SHIP WGT	
EP126	EP126S	One 12" x 62" Enclosure Panel	5 lbs	
EP166	EP166S	One 16" x 62" Enclosure Panel	6 lbs	
EP196	EP196S	One 19" x 62" Enclosure Panel	7 lbs	
EP226	EP226S	One 22" x 62" Enclosure Panel	8 lbs	
EP127	EP127S	One 12" x 73" Enclosure Panel	6 lbs	
EP167	EP167S	One 16" x 73" Enclosure Panel	7 lbs	
EP197	EP197S	One 19" x 73" Enclosure Panel	8 lbs	
EP227	EP227S	One 22" x 73" Enclosure Panel	9 lbs	
EP128	EP128S	One 12" x 84" Enclosure Panel	7 lbs	
EP168	EP168S	One 16" x 84" Enclosure Panel	8 lbs	
EP198	EP198S	One 19" x 84" Enclosure Panel	9 lbs	
EP228	EP228S	One 22" x 84" Enclosure Panel	10 lbs	

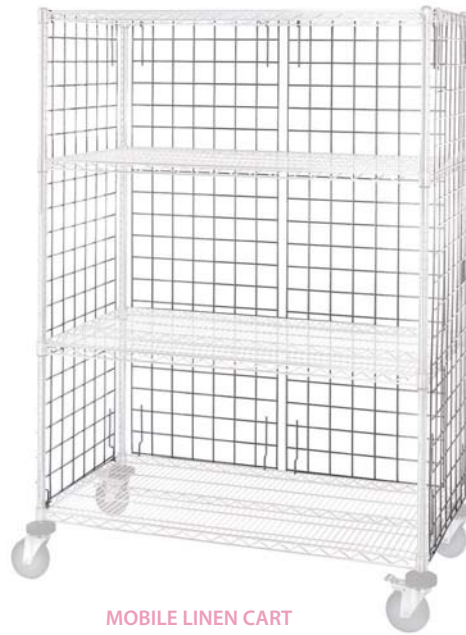

MOBILE LINEN CART SHOWN WITH 4 ENCLOSURE PANELS

Hang Rail



CHROME		STAINLESS STEEL		
MODEL NO.	MODEL NO.	DESCRIPTION	SHIP WGT	
HB18C	HB18S	One 18" Hang Rail	3 lbs	
HB24C	HB24S	One 24" Hang Rail	4 lbs	
HB36C	HB36S	One 36" Hang Rail	5 lbs	
HB48C	HB48S	One 48" Hang Rail	6 lbs	
HB60C	HB60S	One 60" Hang Rail	7 lbs	

CHOOSE FROM ONE BIN / TRAY DESIGN OR TWO BIN / TRAY DESIGN



Single and Double Drawer Slides

Compliment any system with specialized areas for storage which allow bins and trays to be suspended between shelves. Single bin slide mounts 18", 21" and 24" shelves. Double bin slide adapts to 24" shelves only. (Bins sold separately).

MODEL NO.	DESCRIPTION	SHIP WGT
DS18-24	Single Bin Design	2 lbs
DDS-24	Double Bin Design	4 lbs

LINEN MOBILE CARTS AVAILABLE! See pg. 58 & 59



Modular Dolly Frames

Dolly Frames allow standard shelving units to be converted to heavy-duty transport trucks. Frames are fabricated from heavy gauge steel. Bumpers are attached to each corner to protect walls and help cushion impact. **Finishes:** Chrome & Stainless Steel (Plate casters sold separately)

CHROME		STAINLESS STEEL		
MODEL NO.	MODEL NO.	DIMENSIONS W" x L"	SHIP WGT	
DB1836C	DB1836S	18" x 36"	10 lbs	
DB1848C	DB1848S	18" x 48"	12 lbs	
DB1860C	DB1860S	18" x 60"	14 lbs	
DB2436C	DB2436S	24" x 36"	13 lbs	
DB2448C	DB2448S	24" x 48"	15 lbs	
DB2460C	DB2460S	24" x 60"	18 lbs	



SCH1-5

SCH1

Collar Hooks

Used to secure baskets to posts or as a hook for cables. Sold in packs of four.

MODEL NO.	DESCRIPTION	SHIP WGT
SCH1-5	1-1/2" Hook	1 lb
SCH1	1/2" Hook	1 lb

LHA3C Top Shelf View



LHA3C Bottom Shelf View



Label Holders

Are an excellent method for identifying product. Affix directly to truss on any size shelf. Ten lengths to choose from.

MODEL NO.	DESCRIPTION	SHIP WGT
LH3B	3" Gray Label Holder	1 lb
LH3C	3" Clear Label Holder	1 lb
LH12C	12" Clear Label Holder	1 lb
LH24C	24" Clear Label Holder	1 lb
Full Length Label Holders		
LH33C	33" Clear Label Holder Fits 36" Shelf	1 lb
LH39C	39" Clear Label Holder Fits 42" Shelf	1 lb
LH45C	45" Clear Label Holder Fits 40" Shelf	1 lb
LH51C	51" Clear Label Holder Fits 54" Shelf	1 lb
LH57C	57" Clear Label Holder Fits 60" Shelf	1 lb
LH69C	69" Clear Label Holder Fits 72" Shelf	1 lb
Angled Label Holder - 30°, 60° and 90°		
LHA3C	3" Angled Clear Label Holder	1 lb



Push Handle

Comfortable grip design. Five widths available enabling easy movement of any mobile unit.

Finishes: Chrome & Stainless Steel

CHROME		STAINLESS STEEL	
MODEL NO.	MODEL NO.	DESCRIPTION	SHIP WGT
PH18	PH18S	One 18" Push Handle	2 lbs
PH21	PH21S	One 21" Push Handle	3 lbs
PH24	PH24S	One 24" Push Handle	3 lbs
PH30	PH30S*	One 30" Push Handle	3 lbs
PH36	PH36S	One 36" Push Handle	3 lbs

* Special order. Minimum quantity and extended lead time may apply. Please call for details.



U-Handle

Build your own special size utility cart with three different width choices: 18", 21" or 24". Overall height 32", not including casters. **Finishes:** Chrome & Stainless Steel

CHROME		STAINLESS STEEL	
MODEL NO.	MODEL NO.	DESCRIPTION	SHIP WGT
UH18	UH18S	18" U-Handle	2 lbs
UH21	UH21S	21" U-Handle	3 lbs
UH24	UH24S	24" U-Handle	3 lbs

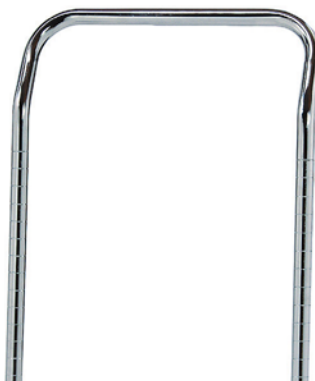

Shelf Inlay Mat

An economical solution to convert a wire shelf to a solid surface preventing items from falling through. White shelf inlay mat is easily removable for cleaning.

MODEL NO.	DESCRIPTION	SHIP WGT
1836SM	One 18" x 36" Inlay Mat	1 lb
1848SM	One 18" x 48" Inlay Mat	2 lbs
1860SM	One 18" x 60" Inlay Mat	2 lbs
1872SM	One 18" x 72" Inlay Mat	2 lbs
2436SM	One 24" x 36" Inlay Mat	2 lbs
2448SM	One 24" x 48" Inlay Mat	2 lbs
2460SM	One 24" x 60" Inlay Mat	2 lbs
2472SM	One 24" x 72" Inlay Mat	3 lbs



Tie Bar

Is required with rigid casters to ensure rigid alignment. Tie bar length should match up to shelf depth. Rigid casters sold separately. **Finish:** Chrome

MODEL NO.	DESCRIPTION	SHIP WGT
18TB	One 18" Tie Bar which fits 2 casters	2 lbs
21TB	One 21" Tie Bar which fits 2 casters	2 lbs
24TB	One 24" Tie Bar which fits 2 casters	2 lbs
30TB	One 30" Tie Bar which fits 2 casters	2 lbs
36TB	One 36" Tie Bar which fits 2 casters	3 lbs



Side and Back Ledges

Ledges are 4"H and act as a perimeter to retain shelf items and prevent anything from falling off.

Finishes: Chrome & Stainless Steel

CHROME		STAINLESS STEEL	
MODEL NO.	MODEL NO.	DESCRIPTION	SHIP WGT
4"H Side Ledges			
SL12	SL12S	12" Side Ledge	1 lb
SL14	SL14S	14" Side Ledge	1 lb
SL18	SL18S	18" Side Ledge	1 lb
SL21	SL21S	21" Side Ledge	2 lbs
SL24	SL24S	24" Side Ledge	2 lbs
SL30	SL30S	30" Side/Back Ledge	2 lbs
4"H Back Ledges			
BL36	BL36S	36" Back/Side Ledge	3 lbs
BL42	BL42S	42" Back Ledge	3 lbs
BL48	BL48S	48" Back Ledge	3 lbs
BL54	BL54S	54" Back Ledge	4 lbs
BL60	BL60S	60" Back Ledge	5 lbs
BL72	BL72S	72" Back Ledge	6 lbs

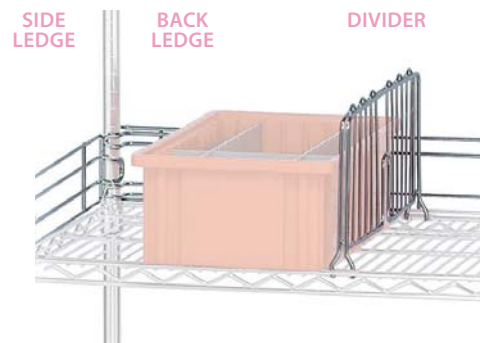

Dividers

Dividers are 8"H and are available in 7 depths to be used with all shelves. Dividers come 2 per package.

Finishes: Chrome & Stainless Steel

CHROME		STAINLESS STEEL	
MODEL NO.	MODEL NO.	DESCRIPTION	SHIP WGT
Dividers			
DIV12	DIV12S	One 12" Divider	2 lbs
DIV14	DIV14S	One 14" Divider	2 lbs
DIV18	DIV18S	One 18" Divider	2 lbs
DIV21	DIV21S	One 21" Divider	3 lbs
DIV24	DIV24S	One 24" Divider	3 lbs
DIV30	DIV30S	One 30" Divider	4 lbs
DIV36	DIV36S	One 36" Divider	4 lbs

Post Clamp

Joins multiple units of shelving.

MODEL NO.	DESCRIPTION	SHIP WGT
PCL1	1/2" Post Clamp	4 lbs
PCL2	3-1/3" Post Clamp	5 lbs





Hang Bar

MODEL NO.	DESCRIPTION	SHIP WGT
GR24	One 24" Hang Bar	2 lbs
GR36	One 36" Hang Bar	3 lbs
GR48	One 48" Hang Bar	4 lbs
GR60	One 60" Hang Bar	5 lbs



HANG BAR

S-Hook

For continuous runs of shelving. Two hooks should be placed per shelf where two posts are not utilized. Sold as an 8 pack. **Finishes:** Chrome, Proform & Stainless Steel



S-HOOKS



KEYBD
Keyboard Shelf

Mounts under any size wire shelf and accepts keyboards up to 21"W x 11"D. Has a 6" height adjustment. Measures 25-1/4"W x 15"D x 4-1/4"H



UB10
Utility Basket

An additional storage or display area outside the perimeter of the shelf. Measures 11-1/4" x 18-7/8" x 7-5/8"H

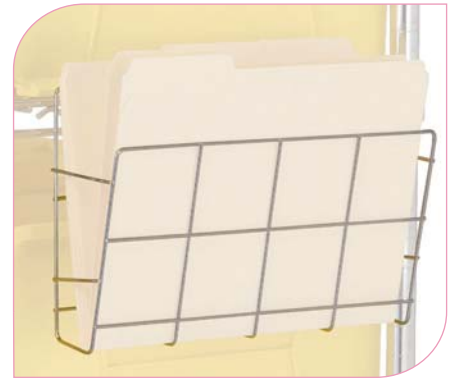

DH8
Document Holder

Provides an effective way to secure documents. Measures 12-3/8" x 2" x 8-5/8"H

Conductive Applications



WR-SSCO
Plastic Conductive Split Sleeve
Sold as a pack of 4 pairs.



ESD-SS
Aluminum Split Sleeve
Aluminum Split Sleeves required when grounding standard wire shelving in conductive application. Sold as a pack of 4 pairs



ESD-DC
Drag Chain
Drag chain is mounted to bottom of shelf and is used to ground standard wire shelving units. Used in conjunction with aluminum or conductive split sleeves.



FP
Foot Plate

Triangular plate allows additional surface to disperse weight.



FG
Non-Marring Floor Glides
Serves as protection to prevent marring of floors. Sold as a 4 pack.



WR-SS
Split Sleeve
Sold as a pack of 4 pairs.



WR-SP
Shelf Collar Plug
Sold as a pack of 4 pieces.



WR-WMB
Post Wall Mount Bracket
Mounts post to wall securely. 2" clearance required.

Casters

MODEL NO.	DESCRIPTION	LOAD CAP PER CASTER	SHIP WGT
Stem Casters			
WR-00H	Four Swivel 5" x 1-1/4" Polyurethane Casters, 2 with brake	300 lbs	10 lbs
WR-00HS	Four Swivel 5" x 1-1/4" Polyurethane Stainless Steel Casters with Zerk Grease Fittings, 2 with brake	300 lbs	12 lbs
WR-00CO	Four Swivel ESD/Conductive 5" x 1-1/4" Casters, 2 with brake	300 lbs	12 lbs
WR-3	Four Swivel 3" Polyurethane, all with brake	200 lbs	8 lbs
WR-RG*	One Rigid 5" x 1-1/4" Polyurethane Caster	300 lbs	3 lbs
WR-PS	One Swivel 8" x 2-1/2" Pneumatic Caster	325 lbs	4 lbs
Plate Casters			
PT-PS	One Swivel 5" x 1-1/4" Polyurethane Caster	300 lbs	3 lbs
PT-PR	One Rigid 5" x 1-1/4" Polyurethane Caster	300 lbs	3 lbs
PT-PSB	One Swivel 5" x 1-1/4" Polyurethane Caster with brake	300 lbs	3 lbs
PT-PS6	One Swivel 6" x 2" Polyurethane Caster	800 lbs	5 lbs
PT-PR6	One Rigid 6" x 2" Polyurethane Caster	800 lbs	5 lbs
PT-PSB6	One Swivel 6" x 2" Polyurethane Caster with brake	800 lbs	5 lbs
PT-NS	One Swivel 8" x 2-1/2" Pneumatic Caster	325 lbs	4 lbs
PT-NR	One Rigid 8" x 2-1/2" Pneumatic Caster	325 lbs	4 lbs

* Requires Tie Bar for rigid alignment. See pg. 77.

ADD CASTERS
to your unit for mobility!

Donut Bumper



Non-marking, 3" diameter rubber bumper used to protect walls and help cushion impact.

MODEL NO.	DESCRIPTION	SHIP WGT
DB	One 3" Diameter Donut Bumper	1 lbs



WR-00H
Shown with and without brake
Sold as a set of 4 casters, 2 with brake



WR-00HS
Shown with and without brake
Sold as a set of 4 casters, 2 with brake



WR-3
Sold as a set of 4 casters, all with brake

WR-PS

PT-NR

PT-NS

WR-RG
Requires Tie Bar
(See chart on pg. 77)



Clear-View Ultra Stack and Hang Bins



Organize your inventory with strong injection molded tri-clear polypropylene bins. Front, back and side grips for easy handling. Built in rear hanger allows bins to hang from louvered panels or rails. Optional clear injection molded crystal styrene window increases bin capacity and provides quick view of bin contents. Dividers maximize flexibility and keep contents organized. Wide stacking ledge and anti-slide lock keep stacked bins steady and prevent forward shifting. Water-proof bins resist rust and corrosion. Large molded front label slots for ID labels. Autoclavable up to 250°F and resistant to extreme cold.



Available in: ● Clear

MODEL NO.	OUTSIDE DIMENSIONS L" x W" x H"	CTN QTY	CTN WGT
QUS200CL	5" x 4-1/8" x 3"	24	5 lbs
QUS210CL	5-3/8" x 4-1/8" x 3"	24	6 lbs
QUS220CL	7-3/8" x 4-1/8" x 3"	24	8 lbs
QUS221CL	9-1/4" x 6" x 5"	12	6 lbs
QUS224CL	10-7/8" x 4-1/8" x 4"	12	8 lbs
QUS230CL	10-7/8" x 5-1/2" x 5"	12	10 lbs
QUS234CL	14-3/4" x 5-1/2" x 5"	12	14 lbs
QUS235CL	10-7/8" x 11" x 5"	6	10 lbs
QUS239CL	10-3/4" x 8-1/4" x 7"	6	10 lbs
QUS240CL	14-3/4" x 8-1/4" x 7"	12	24 lbs
QUS241CL	13-5/8" x 8-1/4" x 6"	12	22 lbs
QUS242CL	13-5/8" x 8-1/4" x 8"	12	25 lbs
QUS245CL	10-7/8" x 16-1/2" x 5"	6	13 lbs
QUS250CL	14-3/4" x 16-1/2" x 7"	6	21 lbs
QUS255CL	16" x 11" x 8"	4	14 lbs
QUS260CL	18" x 11" x 10"	4	17 lbs
QUS265CL	18" x 8-1/4" x 9"	6	17 lbs
QUS270CL	18" x 16-1/2" x 11"	3	16 lbs
QUS275MOBCL	18" x 16-1/2" x 11"*	3	25 lbs

* With casters, overall height for mobile container will be increased by 3"
Individual labels are available for all Ultra Bins. Ctn Qty: 50 Individual Labels
For label Model No., substitute "L" for "Q" in bin Model No.

Clear-View Ultra Stack and Hang Bin Wire Shelving Systems
Complete Packages

Manufactured of FDA approved, heavy-duty tri-clear polypropylene allowing quick identification of the contents of any bin.



WR8-240CL



Available Wire Units Finishes
Chrome, Stainless Steel
and Proform

QUANTUM IS CLEARLY
your storage solution!



MOBILIZE YOUR WIRE SHELVING

DB - Donut Bumper
Non-marking donut bumper used to protect walls and help cushion impact.

WR-00H (Mobile Kit)*
Set of four swivel polyurethane 5" x 1-1/4" casters, two with brakes. Can be used with all units shown. 1,200 lb. load capacity. *Mobile kits recommended only for shelves 18" and wider.

COMPLETE PACKAGES
with bins!

MODEL NO.	NO. OF SHELVES	NO. OF BINS	BIN SIZE L" x W" x H"	SHIP WGT
12" x 36" x 74" Unit				
WR8-239CL	8	28 QUS239CL	10-3/4" x 8-1/4" x 7"	103 lbs
WR7-245CL	7	24 QUS245CL	10-7/8" x 16-1/2" x 5"	111 lbs
14" x 36" x 74" Unit				
WR10-230240CL	10	36 QUS230CL 12 QUS240CL	10-7/8" x 5-1/2" x 5" 14-3/4" x 8-1/4" x 7"	146 lbs
WR8-240CL	8	28 QUS240CL	14-3/4" x 8-1/4" x 7"	128 lbs
WR8-250CL	8	14 QUS250CL	14-3/4" x 16-1/2" x 7"	129 lbs
18" x 36" x 74" Unit				
WR8-255CL	8	21 QUS255CL	16" x 11" x 8"	152 lbs
WR6-260CL	6	15 QUS260CL	18" x 11" x 10"	127 lbs
WR6-265CL	6	20 QUS265CL	18" x 8-1/4" x 9"	124 lbs
WR5-270CL	5	8 QUS270CL	18" x 16-1/2" x 11"	104 lbs



Exclusive! Clear-View HULK 24" Containers



Available in: ● Clear

MODEL NO.	OUTSIDE DIMENSIONS L" x W" x H"	CTN QTY	CTN WGT
QUS950CL	23-7/8" x 8-1/4" x 7"	6	18 lbs
QUS951CL	23-7/8" x 8-1/4" x 9"	6	21 lbs
QUS952CL	23-7/8" x 11" x 7"	4	14 lbs
QUS953CL	23-7/8" x 11" x 10"	4	18 lbs
QUS954CL	23-7/8" x 16-1/2" x 11"	1	7 lbs
QUS964MOBCL	23-7/8" x 16-1/2" x 11"	1	9 lbs
QUS955CL	23-7/8" x 18-1/4" x 12"	1	8 lbs
QUS965MOBCL	23-7/8" x 18-1/4" x 12"	1	10 lbs

* With casters, overall height for mobile container will be increased by 3"



QUANTUM IS CLEARLY your storage solution!



MOBILIZE YOUR WIRE SHELVING

DB - Donut Bumper

Non-marking donut bumper used to protect walls and help cushion impact.

WR-00H (Mobile Kit)*

Set of four swivel polyurethane 5" x 1-1/4" casters, two with brakes. Can be used with all units shown. 1,200 lb. load capacity. *Mobile kits recommended only for shelves 18" and wider.

Clear-View HULK 24" Container Wire Shelving Systems Complete Packages

Manufactured of FDA approved, heavy-duty tri-clear polypropylene allowing quick identification of the contents of any bin.

COMPLETE PACKAGES with containers!

MODEL NO.	NO. OF SHELVES	NO. OF BINS	BIN SIZE L" x W" x H"	SHIP WGT
24" x 36" x 74" Unit				
WR8-950CL	8	28 QUS950CL	23-7/8" x 8-1/4" x 7"	205 lbs
WR8-950952CL	8	12 QUS950CL	23-7/8" x 8-1/4" x 7"	197 lbs
		12 QUS952CL	23-7/8" x 11" x 7"	
WR8-952CL	8	21 QUS952CL	23-7/8" x 11" x 7"	191 lbs
WR7-951CL	7	24 QUS951CL	23-7/8" x 8-1/4" x 9"	188 lbs
		8 QUS950CL	23-7/8" x 8-1/4" x 7"	
WR7-20-MIXCL	7	4 QUS951CL	23-7/8" x 8-1/4" x 9"	182 lbs
		3 QUS952CL	23-7/8" x 11" x 7"	
		3 QUS953CL	23-7/8" x 11" x 10"	
		2 QUS954CL	23-7/8" x 16-1/2" x 11"	
WR6-953CL	6	15 QUS953CL	23-7/8" x 11" x 10"	156 lbs
WR6-953954CL	6	9 QUS953CL	23-7/8" x 11" x 10"	159 lbs
		4 QUS954CL	23-7/8" x 16-1/2" x 11"	
WR6-954CL	6	10 QUS954CL	23-7/8" x 16-1/2" x 11"	164 lbs
24" x 42" x 74" Unit				
WR5-955CL	5	8 QUS955CL	23-7/8" x 18-1/4" x 12"	145 lbs



Available Wire Units Finishes

Chrome, Stainless Steel
and Proform



WR6-953CL



Clear-View Dividable Grid Containers



Heavy-duty Dividable Grid Containers can be used for storage, kitting and distribution applications. These containers offer the safest and most efficient method for compartmentalizing and protecting small to medium sized items. Dividers allow you to customize the container's interior to meet your exact needs. Dividers: Gray. Covers are available in Clear, see pg. 117 to order optional accessories.

Available in: ● Clear

MODEL NO.	OUTSIDE DIMENSIONS L" x W" x H"	INSIDE DIMENSIONS L" x W" x H"	CTN QTY	CTN WGT
DG91035CL	10-7/8" x 8-1/4" x 3-1/2"	9-3/16" x 6-9/16" x 3"	20	24 lbs
DG91050CL	10-7/8" x 8-1/4" x 5"	9-3/16" x 6-9/16" x 4-1/2"	20	32 lbs
DG92035CL	16-1/2" x 10-7/8" x 3-1/2"	14-7/8" x 9-1/4" x 3"	12	23 lbs
DG92060CL	16-1/2" x 10-7/8" x 6"	14-7/8" x 9-1/4" x 5-1/2"	8	20 lbs
DG92080CL	16-1/2" x 10-7/8" x 8"	14-7/8" x 9-1/4" x 7-1/2"	8	27 lbs
DG93030CL	22-1/2" x 17-1/2" x 3"	20-5/8" x 15-5/8" x 2-1/2"	6	20 lbs
DG93060CL	22-1/2" x 17-1/2" x 6"	20-5/8" x 15-5/8" x 5-1/2"	3	16 lbs
DG93080CL	22-1/2" x 17-1/2" x 8"	20-5/8" x 15-5/8" x 7-1/2"	3	19 lbs
DG93120CL	22-1/2" x 17-1/2" x 12"	20-5/8" x 15-5/8" x 11-1/2"	3	23 lbs



DG93080CL
Shown with optional
Cover COV93000CL
(Sold separately)



QUANTUM IS CLEARLY
your storage solution!



MOBILIZE YOUR WIRE SHELVING

DB - Donut Bumper

Non-marking donut bumper used to protect walls and help cushion impact.

WR-00H (Mobile Kit)*

Set of four swivel polyurethane 5" x 1-1/4" casters, two with brakes. Can be used with all units shown. 1,200 lb. load capacity. *Mobile kits recommended only for shelves 18" and wider.



Available Wire Units Finishes
Chrome, Stainless Steel
and Proform

COMPLETE PACKAGES
with containers!

Clear-View Dividable Grid Container Wire Shelving Systems
Complete Packages

Same durable chrome wire shelving combined with Quantum's Clear-View Dividable Grid Containers. These containers allow for multiple compartment configurations within each bin. Offering four different packages, these systems are ideal for small, medium and large parts storage. Unit may be made mobile with the addition of the WR-00H mobile kit. See pg. 117 for additional information and to order optional accessories.

MODEL NO.	NO. OF SHELVES	NO. OF BINS	BIN DIMENSIONS L" x W" x H"	SHIP WGT
18" x 48" x 74" Wire Shelving Unit With Dividable Grid Containers				
WR9-92060CL	9	36 DG92060CL	16-1/2" x 10-7/8" x 6"	210 lbs
WR7-92080CL	7	24 DG92080CL	16-1/2" x 10-7/8" x 8"	174 lbs
24" x 60" x 63" Wire Shelving Unit With Dividable Grid Containers				
WR12-93030CL	12	36 DG93030CL	22-1/2" x 17-1/2" x 3"	274 lbs
24" x 60" x 74" Wire Shelving Unit With Dividable Grid Containers				
WR9-93060CL	9	24 DG93060CL	22-1/2" x 17-1/2" x 6"	254 lbs



WR7-92080CL



Clear-View Giant Stack & Stock Containers



Available in: ● Clear

MODEL NO.	OUTSIDE DIMENSIONS L" x W" x H"	CTN QTY	CTN WGT	WINDOW	CTN QTY
QGH600CL	17-1/2" x 10-7/8" x 12-1/2"	4	12 lbs	WGH600	4
QGH700CL*	15-1/4" x 19-7/8" x 12-7/16"	3	13 lbs	WGH700	3
QGH800CL	17-1/2" x 16-1/2" x 12-1/2"	2	8 lbs	WGH800	2

* Optional label for QGH700 is available, LGH700 (3 per package)

QUANTUM IS CLEARLY
your storage solution!

Clear-View Mobile Giant Stack & Stock Containers



- Ideal for transport of heavy and bulky parts
- Container comes with 4 swivel, 3" casters, all with brakes, allowing for up to 250 lb. mobile load capacity
- Containers can stack with casters in place



QGH705MOBCL

Available in: ● Clear

MODEL NO.	OUTSIDE DIMENSIONS L" x W" x H"	CTN QTY	CTN WGT
QGH705MOBCL	15-1/4" x 19-7/8" x 12-7/16"*	3	22 lbs
QGH805MOBCL	17-1/2" x 16-1/2" x 12-1/2"*	2	17 lbs

* With casters, overall height for mobile container will be increased by 3"



MOBILIZE YOUR WIRE SHELVING

DB - Donut Bumper

Non-marking donut bumper used to protect walls and help cushion impact.

WR-00H (Mobile Kit)*

Set of four swivel polyurethane 5" x 1-1/4" casters, two with brakes. Can be used with all units shown. 1,200 lb. load capacity. *Mobile kits recommended only for shelves 18" and wider.

MODEL NO.	NO. OF BINS	BIN SIZE L" x W" x H"	SHIP WGT
18" x 36" x 74" Unit, 5 Shelves			
WR5-600CL	12 QGH600CL	17-1/2" x 10-7/8" x 12-1/2"	104 lbs
WR5-600800CL	6 QGH600CL	17-1/2" x 10-7/8" x 12-1/2"	103 lbs
	4 QGH800CL	17-1/2" x 16-1/2" x 12-1/2"	
WR5-800CL	8 QGH800CL	17-1/2" x 16-1/2" x 12-1/2"	102 lbs
18" x 42" x 74" Unit, 5 Shelves			
WR5-700CL	8 QGH700CL	15-1/4" x 19-7/8" x 12-7/16"	98 lbs

Multipurpose, wide open hopper front provides easy access for large part storage. Ideal for multiple applications in recycling, storing parts, tools and warehouse items. This bin will stack up to 6 bins high creating a sturdy, tall storage system. Injection molded from high density tri-clear polypropylene, easy to clean, resists rust and corrosion and impervious to most chemicals. Large label holder allows for quick identification. Optional clear window increases storage capacity and allows for inspection of parts. Six 1/4" drill hole pattern on bottom of bin allows for easy hole insertion for drainage.



QGH700CL



Clear-View Giant Stack Wire Shelving Systems
Complete Packages

Manufactured of FDA approved, heavy-duty tri-clear polypropylene allowing quick identification of the contents of any bin.



Available Wire Units Finishes
Chrome, Stainless Steel
and Proform



WR5-600CL

COMPLETE PACKAGES
with containers!



Exclusive! Clear-View Economy Shelf Bins



Quantum's tough, durable, high density Shelf Bins are the industry standard for quality. These durable tri-clear polypropylene bins feature a molded-in label holder, built-in rear hanglock which allows bins to tilt out for complete access when on shelving. A wide hopper front allows complete access to the contents of the bin. Edges are reinforced for added strength. They are designed for 12", 18" and 24" deep shelf units, racks or standard shelving. Bins are impervious to most chemicals. Dividers, bin cups and label holders available on pg. 108.



Available Wire Units Finishes
Chrome, Stainless Steel
and Proform

Clear-View Economy Shelf Bin
Wire Shelving Systems
Complete Packages

Manufactured of FDA approved, heavy-duty tri-clear polypropylene allowing quick identification of the contents of any bin.



WR12-107CL

Clear-View Complete Bin Center

Complete bin systems are available with 4 different size bins on a 12"W x 36"L x 36"H unit. This all-purpose bin center is an economical high density storage system that provides easy visibility to stored contents.



WR6-36-1236-109CL

Available in: Clear

MODEL NO.	OUTSIDE DIMENSIONS L" x W" x H"	CTN QTY	CTN WGT
QSB100CL	11-5/8" x 2-3/4" x 4"	36	13 lbs
QSB101CL	11-5/8" x 4-1/8" x 4"	36	17 lbs
QSB102CL	11-5/8" x 6-5/8" x 4"	30	18 lbs
QSB107CL	11-5/8" x 8-3/8" x 4"	20	15 lbs
QSB109CL	11-5/8" x 11-1/8" x 4"	8	7 lbs
QSB103CL	17-7/8" x 4-1/8" x 4"	20	13 lbs
QSB104CL	17-7/8" x 6-5/8" x 4"	20	16 lbs
QSB108CL	17-7/8" x 8-3/8" x 4"	10	11 lbs
QSB110CL	17-7/8" x 11-1/8" x 4"	8	11 lbs
QSB105CL	23-5/8" x 4-1/8" x 4"	16	13 lbs
QSB106CL	23-5/8" x 6-5/8" x 4"	8	9 lbs
QSB114CL	23-5/8" x 8-3/8" x 4"	6	9 lbs
QSB116CL	23-5/8" x 11-1/8" x 4"	6	10 lbs

Individual labels are available for all Shelf Bins. For label Model No. substitute "L" for "Q" in bin Model No. Ctn Qty: 50 Individual Labels

QUANTUM IS CLEARLY
your storage solution!



MOBILIZE YOUR WIRE SHELVING

DB - Donut Bumper

Non-marking donut bumper used to protect walls and help cushion impact.

WR-00H (Mobile Kit)*

Set of four swivel polyurethane 5" x 1-1/4" casters, two with brakes. Can be used with all units shown. 1,200 lb. load capacity. *Mobile kits recommended only for shelves 18" and wider.

MODEL NO.	NO. OF BINS	BIN SIZE L" x W" x H"	SHIP WGT
12" x 36" x 36" Unit, 6 Shelves			
WR6-36-1236-101CL	40 QSB101CL	11-5/8" x 4-1/8" x 4"	63 lbs
WR6-36-1236-102CL	25 QSB102CL	11-5/8" x 6-5/8" x 4"	50 lbs
WR6-36-1236-107CL	20 QSB107CL	11-5/8" x 8-3/8" x 4"	62 lbs
WR6-36-1236-109CL	15 QSB109CL	11-5/8" x 11-1/8" x 4"	64 lbs

COMPLETE PACKAGES
with bins!

MODEL NO.	NO. OF BINS	BIN SIZE L" x W" x H"	SHIP WGT
12" x 36" x 74" Unit, 12 Shelves			
WR12-101CL	77 QSB101CL	11-5/8" x 4-1/8" x 4"	114 lbs
WR12-102CL	55 QSB102CL	11-5/8" x 6-5/8" x 4"	116 lbs
WR12-107CL	44 QSB107CL	11-5/8" x 8-3/8" x 4"	117 lbs
WR12-109CL	33 QSB109CL	11-5/8" x 11-1/8" x 4"	119 lbs
18" x 36" x 74" Unit, 12 Shelves			
WR12-103CL	77 QSB103CL	17-7/8" x 4-1/8" x 4"	169 lbs
WR12-104CL	55 QSB104CL	17-7/8" x 6-5/8" x 4"	165 lbs
WR12-108CL	44 QSB108CL	17-7/8" x 8-3/8" x 4"	170 lbs
WR12-110CL	33 QSB110CL	17-7/8" x 11-1/8" x 4"	168 lbs
24" x 36" x 74" Unit, 12 Shelves			
WR12-105CL	77 QSB105CL	23-5/8" x 4-1/8" x 4"	219 lbs
WR12-106CL	55 QSB106CL	23-5/8" x 6-5/8" x 4"	218 lbs
WR12-114CL	44 QSB114CL	23-5/8" x 8-3/8" x 4"	222 lbs
WR12-116CL	33 QSB116CL	23-5/8" x 11-1/8" x 4"	206 lbs



Exclusive! Clear-View STORE-MORE 6" Shelf Bins



Maximize your storage space with durable, high density polypropylene bins. Quantum's exclusive STORE-MORE 6"H Shelf Bins are the industry standard for quality. These bins feature a molded-in label holder, built-in rear hang-lock which allows bins to tilt out for complete access when on shelving. A wide hopper front allows complete access to the contents of the bin. Edges are reinforced for added strength. They are designed for 12", 18" and 24" deep shelf units, racks or standard shelving. Optional dividers are a perfect solution to create a par level system. Bins are waterproof and corrosion-free. Dividers, bin cups and label holders available on pg. 110.



CLEAR VIEW



Available Wire Units Finishes
Chrome, Stainless Steel and Proform

Clear-View STORE-MORE 6" Shelf Bin Wire Shelving Systems Complete Packages

Manufactured of FDA approved, heavy-duty tri-clear polypropylene allowing quick identification of the contents of any bin.



WR9-202CL

Clear-View Complete Bin Center

Complete bin systems are available with 4 different size bins on a 12"W x 36"L x 39"H unit. This all-purpose bin center is an economical high density storage system that provides easy visibility to stored contents.



WR5-39-1236-209CL

Available in: Clear

MODEL NO.	OUTSIDE DIMENSIONS L" x W" x H"	CTN QTY	CTN WGT
QSB201CL	11-5/8" x 4-1/8" x 6"	36	19 lbs
QSB202CL	11-5/8" x 6-5/8" x 6"	30	20 lbs
QSB207CL	11-5/8" x 8-3/8" x 6"	20	17 lbs
QSB209CL	11-5/8" x 11-1/8" x 6"	8	9 lbs
QSB203CL	17-7/8" x 4-1/8" x 6"	20	15 lbs
QSB204CL	17-7/8" x 6-5/8" x 6"	20	18 lbs
QSB208CL	17-7/8" x 8-3/8" x 6"	10	13 lbs
QSB210CL	17-7/8" x 11-1/8" x 6"	8	13 lbs
QSB205CL	23-5/8" x 4-1/8" x 6"	16	15 lbs
QSB206CL	23-5/8" x 6-5/8" x 6"	8	11 lbs
QSB214CL	23-5/8" x 8-3/8" x 6"	6	11 lbs
QSB216CL	23-5/8" x 11-1/8" x 6"	6	12 lbs

Individual labels are available for all Shelf Bins. Ctn Qty: 50 Individual Labels
For label Model No. substitute "L" for "Q" in bin Model No.

QUANTUM IS CLEARLY
your storage solution!



MOBILIZE YOUR WIRE SHELVING

DB - Donut Bumper
Non-marking donut bumper used to protect walls and help cushion impact.

WR-00H (Mobile Kit)*
Set of four swivel polyurethane 5" x 1-1/4" casters, two with brakes. Can be used with all units shown. 1,200 lb. load capacity. *Mobile kits recommended only for shelves 18" and wider.

MODEL NO.	NO. OF BINS	BIN SIZE L" x W" x H"	SHIP WGT
12" x 36" x 39" Unit, 5 Shelves			
WR5-39-1236-201CL	32 QSB201CL	11-5/8" x 4-1/8" x 6"	61 lbs
WR5-39-1236-202CL	20 QSB202CL	11-5/8" x 6-5/8" x 6"	57 lbs
WR5-39-1236-207CL	16 QSB207CL	11-5/8" x 8-3/8" x 6"	56 lbs
WR5-39-1236-209CL	12 QSB209CL	11-5/8" x 11-1/8" x 6"	55 lbs

COMPLETE PACKAGES
with bins!

MODEL NO.	NO. OF BINS	BIN SIZE L" x W" x H"	SHIP WGT
12" x 36" x 74" Unit, 9 Shelves			
WR9-201CL	64 QSB201CL	11-5/8" x 4-1/8" x 6"	108 lbs
WR9-202CL	40 QSB202CL	11-5/8" x 6-5/8" x 6"	100 lbs
WR9-207CL	32 QSB207CL	11-5/8" x 8-3/8" x 6"	98 lbs
WR9-209CL	24 QSB209CL	11-5/8" x 11-1/8" x 6"	96 lbs
18" x 36" x 74" Unit, 9 Shelves			
WR9-203CL	64 QSB203CL	17-7/8" x 4-1/8" x 6"	156 lbs
WR9-204CL	40 QSB204CL	17-7/8" x 6-5/8" x 6"	142 lbs
WR9-208CL	32 QSB208CL	17-7/8" x 8-3/8" x 6"	143 lbs
WR9-210CL	24 QSB210CL	17-7/8" x 11-1/8" x 6"	140 lbs
24" x 36" x 74" Unit, 9 Shelves			
WR9-205CL	64 QSB205CL	23-5/8" x 4-1/8" x 6"	182 lbs
WR9-206CL	40 QSB206CL	23-5/8" x 6-5/8" x 6"	171 lbs
WR9-214CL	32 QSB214CL	23-5/8" x 8-3/8" x 6"	165 lbs
WR9-216CL	24 QSB216CL	23-5/8" x 11-1/8" x 6"	154 lbs



Exclusive! Clear-View STORE-MAX 8" Shelf Bins



Quantum revolutionized the Shelf Bin market when we first introduced the 6" high Shelf Bins. Building on that success we are proud to showcase our new 8" high bins-offering 95% more storage capacity when compared to the standard 4" high bins and 65% more than the 6" high bins. The new STORE-MAX 8" Bins will truly maximize and organize your space. Manufactured from high density polypropylene, Quantum's exclusive STORE-MAX 8"H Shelf Bins are the industry standard for quality. These bins feature a molded-in label holder on a wide hopper front allowing complete access to the contents of the bin. Edges are reinforced for added strength. They are designed for 12", 18" and 24" deep shelf units, racks or standard shelving. Optional dividers are a perfect accessory to subdivide and keep parts separated as needed. Available on pg. 112.



Clear-View STORE-MAX 8" Shelf Bin Wire Shelving Systems Complete Packages

Manufactured of FDA approved, heavy-duty tri-clear polypropylene allowing quick identification of the contents of any bin.

Available Wire Units Finishes
Chrome, Stainless Steel and Proform

Clear-View Complete Bin Center

Complete bin systems are available with 4 different size bins on a 12"W x 36"L x 39"H unit. This all-purpose bin center is an economical high density storage system that provides easy visibility to stored contents.



WR4-39-1236-809CL

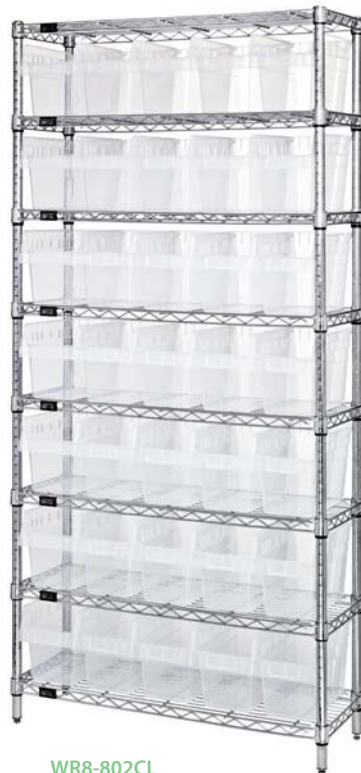

WR8-802CL

Available in: Clear

MODEL NO.	OUTSIDE DIMENSIONS L" x W" x H"	CTN QTY	CTN WGT
QSB801CL	11-5/8" x 4-3/8" x 8"	36	27 lbs
QSB802CL	11-5/8" x 6-5/8" x 8"	30	26 lbs
QSB807CL	11-5/8" x 8-3/8" x 8"	20	21 lbs
QSB809CL	11-5/8" x 11-1/8" x 8"	8	11 lbs
QSB803CL	17-7/8" x 4-3/8" x 8"	20	22 lbs
QSB804CL	17-7/8" x 6-5/8" x 8"	20	26 lbs
QSB808CL	17-7/8" x 8-3/8" x 8"	10	15 lbs
QSB810CL	17-7/8" x 11-1/8" x 8"	8	17 lbs
QSB805CL	23-5/8" x 4-3/8" x 8"	16	24 lbs
QSB806CL	23-5/8" x 6-5/8" x 8"	8	13 lbs
QSB814CL	23-5/8" x 8-3/8" x 8"	6	12 lbs
QSB816CL	23-5/8" x 11-1/8" x 8"	6	14 lbs

Individual labels are available for all Shelf Bins.
For label Model No. substitute "L" for "Q" in bin Model No.

Ctn Qty: 50 Individual Labels

QUANTUM IS CLEARLY your storage solution!



MOBILIZE YOUR WIRE SHELVING

DB - Donut Bumper
Non-marking donut bumper used to protect walls and help cushion impact.

WR-00H (Mobile Kit)*
Set of four swivel polyurethane 5" x 1-1/4" casters, two with brakes. Can be used with all units shown. 1,200 lb. load capacity. *Mobile kits recommended only for shelves 18" and wider.

MODEL NO.	NO. OF BINS	BIN SIZE L" x W" x H"	SHIP WGT
12" x 36" x 39" Unit, 4 Shelves			
WR4-39-1236-801CL	21 QSB801CL	11-5/8" x 4-3/8" x 8"	80 lbs
WR4-39-1236-802CL	15 QSB802CL	11-5/8" x 6-5/8" x 8"	78 lbs
WR4-39-1236-807CL	12 QSB807CL	11-5/8" x 8-3/8" x 8"	77 lbs
WR4-39-1236-809CL	9 QSB809CL	11-5/8" x 11-1/8" x 8"	77 lbs

COMPLETE PACKAGES with bins!

MODEL NO.	NO. OF BINS	BIN SIZE L" x W" x H"	SHIP WGT
12" x 36" x 74" Unit, 8 Shelves			
WR8-801CL	49 QSB801CL	11-5/8" x 4-3/8" x 8"	100 lbs
WR8-802CL	35 QSB802CL	11-5/8" x 6-5/8" x 8"	103 lbs
WR8-807CL	28 QSB807CL	11-5/8" x 8-3/8" x 8"	102 lbs
WR8-809CL	21 QSB809CL	11-5/8" x 11-1/8" x 8"	101 lbs
18" x 36" x 74" Unit, 8 Shelves			
WR8-803CL	49 QSB803CL	17-7/8" x 4-3/8" x 8"	150 lbs
WR8-804CL	35 QSB804CL	17-7/8" x 6-5/8" x 8"	142 lbs
WR8-808CL	28 QSB808CL	17-7/8" x 8-3/8" x 8"	138 lbs
WR8-810CL	21 QSB810CL	17-7/8" x 11-1/8" x 8"	141 lbs
24" x 36" x 74" Unit, 8 Shelves			
WR8-805CL	49 QSB805CL	23-5/8" x 4-3/8" x 8"	194 lbs
WR8-806CL	35 QSB806CL	23-5/8" x 6-5/8" x 8"	177 lbs
WR8-814CL	28 QSB814CL	23-5/8" x 8-3/8" x 8"	176 lbs
WR8-816CL	21 QSB816CL	23-5/8" x 11-1/8" x 8"	169 lbs



Bin, Totes and Container Labels



Clear Label Holder Kits allow for easy parts identification and bar coding of the bin contents. Laser and inkjet compatible inserts come in 8-1/2" x 11" perforated sheets. Label holders easily slide into molded-in label slot on bin to protect label. Kit contains 25 clear holders and corresponding printer friendly sheet labels.

Clear Label Holder

Clear label holders and laser label inserts are available for Ultra Stack & Hang Bins. Label are inserted inside clear sleeve for maximum protection. Package of 25.



LTR-2400
Clear Label Holder

Clear Label Holder

Clear Label Holders are available for Economy Shelf Bins STORE-MORE & STORE-MAX Shelf Bins. Laser & Inkjet compatible inserts. Label holders fit all shelf bins (except QSB100). Package of 25.



LTR-0813
Clear Label Holder

Stackable Shelf Bins
pg. 96

Ultra Stack & Hang Bins
pg. 88

Shelf Bins Store-More Store-Max
pg. 108 pg. 110 pg. 112

Individual Labels

Individual Label Inserts are precut to slide into molded-in label slot on bin fronts. Package of 50 individual cut labels (not intended for printer use).



Giant Stack Containers
pg. 104



Shelf Bins Store-More Store-Max
pg. 108 pg. 110 pg. 112



Ultra Stack & Hang Bins
pg. 88

Extended Label Holders

Optional extended label holders are designed for larger bar code scanning. Label holders fit all Shelf Bins (except QSB100).

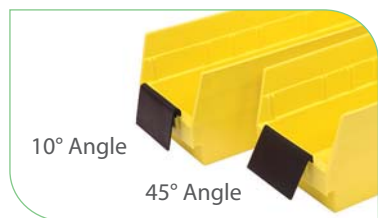

ELH410 & ELH445
Extended Label Holders

Divider Label Tab

Divider Label Tabs attach to existing dividers to improve the visibility of bin labels and scanning of barcodes. Package of 6.



DLT-6
Divider Label Tab

Shelf Bins
pg. 108

Store-More
pg. 110

Store-Max
pg. 112

Clear Label Holder

Three sizes to choose from. Package of 6.

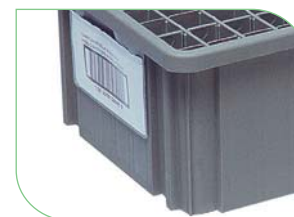

Dividable Grid Containers
pg. 117

Clear Label Holder

Fits all nine sizes of stack and nest totes have ability to use the optional clear label holder. 3" x 5" clear label holder securely attaches to tote with or without lid for easy part identification. Package of 6.



GENUINE stack and nest totes
pg. 118

snh010
Clear Label Holder

Clear Label Holder

Fits all five cross stack tub sizes. 3" x 5" clear label holder securely attaches to tote with or without lid for easy part identification. Package of 6.



Cross stack Tubs
pg. 120

snh010
Clear Label Holder

Clear Adhesive Label Holder

3" x 5" adhesive clear label holder attaches securely to container for easy part identification. Creates a sleeve for up to 3" x 5" label. Package of 24.



Attached Top Containers
pg. 122

QDL-2115
Clear Label Holder

19 SIZES AND 7 COLORS AVAILABLE!
the LARGEST selection anywhere!!



QUS200



QUS210



QUS220



QUS221



QUS239



QUS240



QUS241



QUS242

Ultra Stack and Hang Bins



Organize your inventory with these strong bins, manufactured of FDA approved materials. Front, back and side grips for easy handling. Built-in rear hanger allows bins to hang from louvered panels or rails. Optional clear injection molded crystal styrene window increases bin capacity and provides quick view of bin contents. Dividers maximize flexibility and keep contents organized. Wide stacking ledge and anti-slide lock keep stacked bins steady and prevent forward shifting. Water, rust, and corrosion proof. Easily cleaned with soap and water and impervious to most chemicals. Large molded front label slots for ID labels. Autoclavable up to 250°F and resistant to extreme cold. Guaranteed not to break or crack under normal load conditions. Available in 7 colors. See pg. 80 to order Clear Bins.



Available in: ● Blue ● Green ● Ivory ● Red ● Yellow ● Black ● Clear

MODEL NO.	OUTSIDE DIMENSIONS L" x W" x H"	INSIDE DIMENSIONS L" x W" x H"	X"	CTN QTY	CTN WGT	BIN LOAD CAPACITY*	CLEAR WINDOW	CTN QTY	DIVIDER	CTN QTY	DIVIDER SLOTS	CLEAR LABEL HOLDER	CLEAR LID**	CTN QTY
QUS200	5" x 4-1/8" x 3"	4-3/8" x 3-7/16" x 2-13/16"	3-1/2"	24	5 lbs	8 lbs	-	-	DUS200	6	1	LTR-1300	-	-
QUS210	5-3/8" x 4-1/8" x 3"	4-3/4" x 3-7/16" x 2-13/16"	4"	24	6 lbs	10 lbs	-	-	DUS210	6	1	LTR-1300	COV210	24
QUS220	7-3/8" x 4-1/8" x 3"	6-3/4" x 3-7/16" x 2-13/16"	6"	24	8 lbs	10 lbs	-	-	DUS220	6	1	LTR-1300	COV220	24
QUS221	9-1/4" x 6" x 5"	8-1/2" x 5-1/8" x 4-1/2"	7-1/4"	12	6 lbs	20 lbs	WUS221	12	DUS221	6	1	LTR-1754	-	-
QUS224	10-7/8" x 4-1/8" x 4"	10-1/4" x 3-3/16" x 3-3/4"	9"	12	8 lbs	30 lbs	WUS224	12	DUS224	6	1	LTR-1253	COV224	12
QUS230	10-7/8" x 5-1/2" x 5"	10-1/4" x 4-3/8" x 4-3/4"	9"	12	10 lbs	30 lbs	WUS230/234	12	DUS230/235	6	1	LTR-1754	COV230	12
QUS234	14-3/4" x 5-1/2" x 5"	14-1/16" x 4-3/8" x 4-3/4"	12-13/16"	12	14 lbs	50 lbs	WUS230/234	12	DUS234	6	1	LTR-1754	-	-
QUS235	10-7/8" x 11" x 5"	10-1/4" x 10" x 4-3/4"	9"	6	10 lbs	50 lbs	WUS235	6	DUS230/235	6	3	LTR-1754	COV235	6
QUS239	10-3/4" x 8-1/4" x 7"	10" x 6-9/16" x 6-3/4"	8"	6	10 lbs	50 lbs	WUS239/240	6	DUS239	6	1	LTR-1754	COV239	6
QUS240	14-3/4" x 8-1/4" x 7"	14" x 6-9/16" x 6-3/4"	12"	12	24 lbs	60 lbs	WUS239/240	6	DUS240/250	6	1	LTR-1754	COV240	12
QUS241	13-5/8" x 8-1/4" x 6"	12-1/2" x 6-3/4" x 5-3/8"	11-1/8"	12	22 lbs	60 lbs	WUS241	12	DUS241	6	1	LTR-1754	-	-
QUS242	13-5/8" x 8-1/4" x 8"	12-1/2" x 6-3/4" x 7-3/8"	11-1/8"	12	25 lbs	60 lbs	WUS242	12	DUS242	6	1	LTR-1754	-	-
QUS245	10-7/8" x 16-1/2" x 5"	9-3/4" x 15" x 4-3/4"	9"	6	13 lbs	60 lbs	WUS245	6	DUS245	6	3	LTR-1754	-	-
QUS250	14-3/4" x 16-1/2" x 7"	14" x 14-3/4" x 6-3/4"	12"	6	21 lbs	75 lbs	WUS250	6	DUS240/250	6	3	LTR-1754	-	-
QUS255	16" x 11" x 8"	15-1/8" x 10" x 7-3/4"	11-5/8"	4	14 lbs	75 lbs	WUS255	4	DUS255	6	3	LTR-1754	-	-
QUS260	18" x 11" x 10"	17" x 9-1/2" x 9-3/4"	14-3/16"	4	17 lbs	75 lbs	WUS260	4	DUS260	6	3	LTR-1754	-	-
QUS265	18" x 8-1/4" x 9"	17-1/8" x 6-3/4" x 8-1/4"	14-1/2"	6	17 lbs	60 lbs	WUS265	6	DUS265	6	1	LTR-1754	-	-
QUS270	18" x 16-1/2" x 11"	17-1/8" x 14-3/4" x 10-1/4"	14"	3	16 lbs	75 lbs	WUS270	3	DUS270	6	3	LTR-2400	-	-
QUS275MOB	18" x 16-1/2" x 11"***	17-1/8" x 14-3/4" x 10-1/4"	14"	3	25 lbs	-	WUS270	3	DUS270	6	3	LTR-2400	-	-

* When attached to panels or rails ** Available early 2014 *** With casters, overall height is 14" Individual labels are available for all Ultra Bins. For label Model No., substitute "L" for "Q" in bin Model No. Ctn Qty: 50 Individual Labels



QUS224



QUS230
Shown with optional clear lid COV230
AVAILABLE EARLY 2014
(Sold separately)



QUS234



QUS235



QUS245



QUS250



QUS255



QUS260



QUS265



QUS270



QUS275MOB

PERFORMANCE FEATURES AT A GLANCE:

- Available in 19 sizes
- Standard colors: Blue, Green, Ivory, Red, Yellow, Black and Clear (additional colors available on request, subject to up charge and minimum runs)
- Bins are made from heavy-duty, virgin, high density FDA approved polypropylene
- Large label slots provide easy label insertion and parts identification
- Extra wide stacking ledge assures stability for high stacking
- Reinforced design adds strength and prevents spreading
- Will not rust or corrode, unaffected by weak acids and alkalis, and are waterproof
- Autoclavable up to 250°F
- Interchangeable with other manufactured brands of bins



LTR-2400
Clear Label Holder
Clear label holders and laser label inserts. Package of 25.



QUS235
Shown with optional Divider DUS230/235 (Sold separately)

Standard Colors



Blue



Green



Ivory



Red



Yellow



Black



Clear

Ultra Stack and Hang Bins

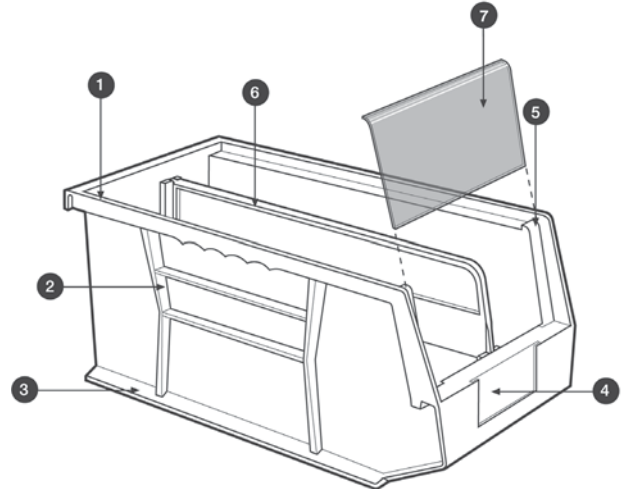

- ❶ Full width hanger supports bin when hanging from louvered panels or rails
- ❷ Reinforced rib design adds strength and prevents spreading
- ❸ Extra-wide stacking ledge for secure stacking
- ❹ Large front label slot allows larger bar code scanning and content identification
- ❺ Anti-slide stop prevents stacked bins from shifting forward
- ❻ Optional dividers increase storage options
- ❼ Optional windows maximize storage capacity, prevent spillage and protects parts from dust and dirt



QUS275MOB
Mobile Ultra Bin

Ideal for transport of heavy and bulky parts
Bin comes with 4 swivel, 3" casters, all with brakes,
allowing up to 250 lb. mobile load capacity



QUS230

Shown with optional clear lid **COV230**
AVAILABLE EARLY 2014
(Sold separately)



QUS245

Shown with optional Window and Divider
(Sold separately)



DLY-3018
Polymer Mobile Dolly

DLY-3018 Dolly with Padded Rubber Trim,
available in Blue. 1,000 lbs. capacity.
Exterior Dimensions 30"L x 18"W
(Bin sold separately)

ATTACHED PULL RING
allows dolly to be pulled
with ease



HANDLE-DLY

32" Dolly Pull Rod with handle

MODEL NO.	DESCRIPTION	CTN WGT
DLY-3018	Dolly with Padded Rubber Trim	19 lbs
HANDLE-DLY	32" Dolly Pull Rod with Handle	2 lbs

Bins sold separately.



Ultra Stack and Hang Bin Wire Shelving Systems - Complete Packages



MOBILIZE YOUR WIRE SHELVING

DB - Donut Bumper

Non-marking donut bumper used to protect walls and help cushion impact.

WR-00H (Mobile Kit)*

Set of four swivel polyurethane 5" x 1-1/4" casters, two with brakes. Can be used with all units shown. 1,200 lb. load capacity. *Mobile kits recommended only for shelves 18" and wider.

COMPLETE PACKAGES with bins!

Units on this page are also available on Steel Shelving

See pg. 138



AVAILABLE on pg. 80

12" and 14" Units

18" Units



WR8-239
12"W x 36"L x 74"H
8 shelves and 28 QUS239
10-3/4"L x 8-1/4"W x 7"H bins



WR8-240
14"W x 36"L x 74"H
8 shelves and 28 QU240
14-3/4"L x 8-1/4"W x 7"H bins



WR8-255
18"W x 36"L x 74"H
8 shelves and 21 QUS255
16"L x 11"W x 8"H bins



WR6-260
18"W x 36"L x 74"H
6 shelves and 15 QUS260
18"L x 11"W x 10"H bins



WR8-250
14"W x 36"L x 74"H
8 shelves and 14 QUS250
14-3/4"L x 16-1/2"W x 7"H bins



WR10-230240
14"W x 36"L x 74"H
10 shelves and 36 QUS230
10-7/8"L x 5-1/2"W x 5"H bins and
12 QUS240 14-3/4"L x 8-1/4"W x 7"H bins



WR6-265
18"W x 36"L x 74"H
6 shelves and 20 QUS265
18"L x 8-1/4"W x 9"H bins



WR5-270
18"W x 36"L x 74"H
5 shelves and 8 QUS270
18"L x 16-1/2"W x 11"H bins

Exclusive! Mesh Stack & Hang Bins



New patented Wire Mesh Bins are an industry exclusive. Our innovative mesh design offers a nickel-chrome finish and a 3/8" x 3/8" grid pattern allowing complete visibility of the bin's contents. This unique mesh pattern provides a dust and dirt free storage environment. Ultra strong design allows for superior hang capacity perfect for IV fluid storage or anything where hang capacities are vital. Available in 9 popular sizes, Quantum's Mesh Bins stack one on top of the other and feature a rear hanger that allows them to hang from any louvered wall panel or rail system. The open hopper design allows for easy picking while allowing visual access to stored contents. Two optional label holders are available for all Mesh Bins. **Finish:** Chrome

MODEL NO.	OUTSIDE DIMENSIONS L" x W" x H"	INSIDE DIMENSIONS L" x W" x H"	CTN QTY	CTN WGT
QMB510C	5-1/4" x 4-1/4" x 3"	4-3/4" x 4" x 2-7/8"	20	12 lbs
QMB520C	7-1/4" x 4-1/4" x 3"	6-3/4" x 4" x 2-7/8"	20	15 lbs
QMB530C	10-3/4" x 5-1/2" x 5"	10-1/4" x 5-1/2" x 4-3/4"	10	12 lbs
QMB535C	10-3/4" x 11" x 5"	10-1/4" x 10-3/4" x 4-3/4"	10	19 lbs
QMB539C	10-1/2" x 8" x 7"	10" x 7-1/2" x 6-3/4"	10	20 lbs
QMB540C	14-1/2" x 8" x 7"	14" x 7-2/5" x 6-3/4"	10	30 lbs
QMB550C	14-1/2" x 16-1/4" x 7"	14" x 15-3/4" x 6-3/4"	5	17 lbs
QMB560C	18-1/2" x 11" x 10-1/4"	18" x 10-5/8" x 10"	5	21 lbs
QMB570C	18-1/2" x 17" x 11-1/4"	18" x 16-5/8" x 11"	5	28 lbs

new



**HIGH VISIBILITY!
EASY TO CLEAN!
ALL WELDED!**
Mesh bins!



QMB560C
Mesh Bin Stacked

9 SIZES AVAILABLE!



QMB510C



QMB520C



QMB530C



QMB535C



QMB539C



QMB540C



QMB550C



QMB560C



QMB570C



QMB539C
Shown with optional
HBL3C
Label Holder
Clear
(Sold separately)

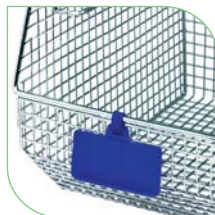

QMB539C
Shown with optional
PS-LH3
Hanging Label Tag
Clear, Red, Yellow,
Blue and Green
(Sold separately)

OUTWARD PIVOTING ARM
Allows full use and visibility of the entire bin

REAR HANGER
All mesh bins have a super strong rear hanger that allows hanging from a louvered panel or rail system

INWARD PIVOTING ARM
Provides a flat stable surface enabling the bins to stack

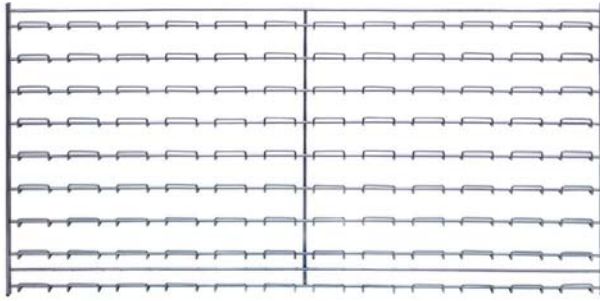

WLP-1836C
36"L x 18"H
Accepts all sizes of Ultra Stack & Hang Bins and Mesh Bins. Includes 8 direct mount clips. 175 lb. load capacity.

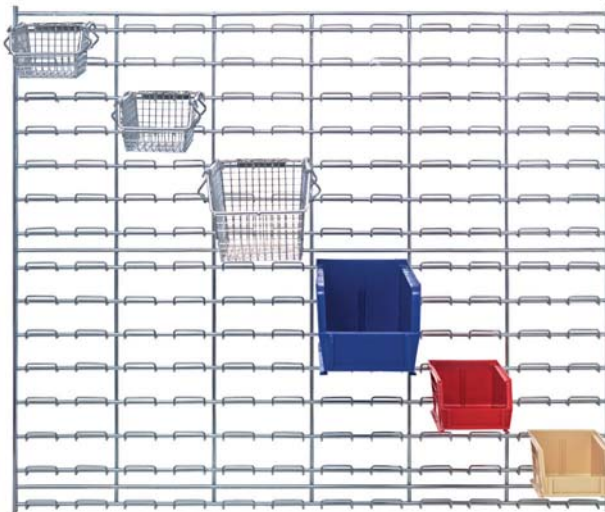

WLP-3036C
36"L x 30"H
Accepts all sizes of Ultra Stack & Hang Bins and Mesh Bins. Includes 12 direct mount clips. (Bins sold separately)

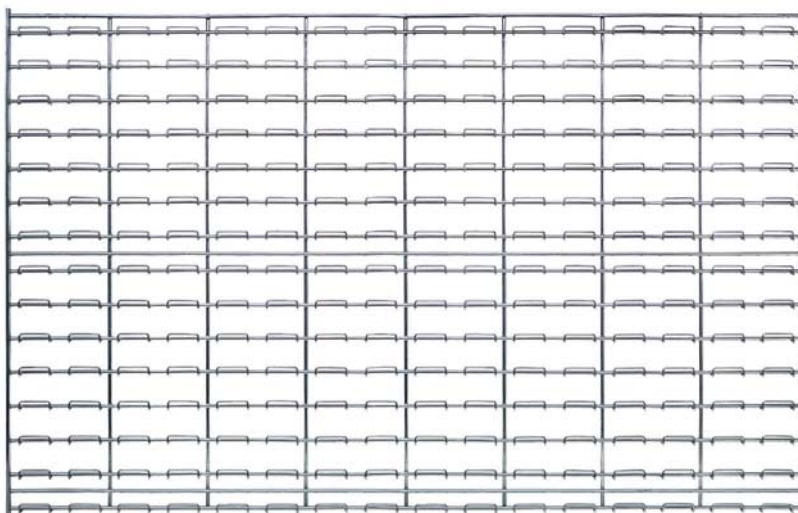

new

Exclusive! Wire Louvered Panel



Quantum's new chrome wire louvered panels offer a perfect mounting solution for all plastic hanging and new wire mesh hanging bins. Unlike a standard louvered panel where there can be the occasional concern of dust or dirt accumulation, Quantum's exclusive offering of wire panels, available in three sizes, completely resist any buildup of dust or dirt. Included direct mounting clips enable fastening to any surface (wall, wood, concrete, drywall, etc.) a snap (note: mounting screws are not included as they differ based on what type of surface the panels are being mounted to). Offset mounting clips are also available, can be used in place of WLP-DMC if you want to have wire panel mounted offset (away) from a wall surface making it easier to clean behind the panel (sold separately). Manufactured of heavy-duty chrome wire, Quantum's wire panels will offer years of dependable and heavy-duty service.

MODEL NO.	DIMENSIONS L" x H"	CTN QTY	CTN WGT
Wire Wall Mounted Louvered Panels			
WLP-1836C	36" x 18" Wire Louvered Panel	1	12 lbs
WLP-3036C	36" x 30" Wire Louvered Panel	1	19 lbs
WLP-3048C	48" x 30" Wire Louvered Panel	1	26 lbs

Accessories



WLP-DMC
Direct Mount Clips - 4 pack
(Included with wire louvered panels)

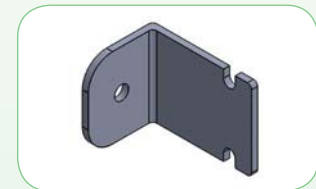

WLP-OSC
Offset Mount Clips - 4 pack
(Sold separately)

WLP-3048C
48"L x 30"H
Accepts all sizes of Ultra Stack & Hang Bins and Mesh Bins. Includes 12 direct mount clips. 175 lb. load capacity.

**HIGH VISIBILITY!
EASY TO CLEAN!
ALL WELDED!**

QUANTITY OF MESH BINS TO FIT LOUVERED PANELS

QUANTITY OF ULTRA BINS TO FIT LOUVERED PANELS

MODEL NO.	QMB 510	QMB 520	QMB 530	QMB 535	QMB 539	QMB 540	QMB 550	QMB 560	QMB 570	QUS 200	QUS 210	QUS 220	QUS 221	QUS 224	QUS 230	QUS 234	QUS 235	QUS 239	QUS 240	QUS 241	QUS 242	QUS 245	QUS 250	QUS 255	QUS 260	QUS 265	QUS 270
WLP-1836C	32	32	18	9	8	8	4	3	2	32	32	32	18	18	18	18	9	8	8	8	8	6	4	6	3	4	2
WLP-3036C	56	56	30	15	16	16	6	6	6	56	56	56	30	30	30	30	15	16	16	16	16	10	6	9	6	8	6
WLP-3048C	77	77	40	20	20	20	8	12	6	77	77	77	40	40	40	40	20	20	20	20	20	10	8	12	12	15	6

See pg. 92 & 88 for bin dimensions.



Ultra Hanging Louvered Panels

Quantum Ultra Bins will hang on louvered panels in a wide range of configurations designed to meet all application needs. Use the system best suited to your needs with your choice of Ultra Bins. Systems are formed from heavy-duty 16 gauge cold rolled steel and have a Gray or Oyster White baked-enamel finish which ensures years of heavy-duty use. Louvered panels may be mounted on any suitable wall surface. Fasten securely to assure adequate load bearing.



QLP-1819HC
18" L x 19" H

Accepts all sizes of Ultra Bins.
175 lb. load capacity.
(Bins sold separately)



QLP-3619HC
36" L x 19" H

Accepts all sizes of Ultra Bins.
175 lb. load capacity.
(Bins sold separately)



QLP-1861HC
18" L x 61" H

Accepts all sizes of Ultra Bins.
250 lb. load capacity.
(Bins sold separately)



QLP-3661HC
36" L x 61" H

Accepts all sizes of Ultra Bins.
500 lbs. load capacity. (Bins sold separately)

MODEL NO.	DIMENSIONS L" x H"	CTN QTY	CTN WGT
Oyster White Wall Mounted Louvered Panels			
QLP-1819HC	18" x 19" Oyster White Louvered Panel	1	6 lbs
QLP-1861HC	18" x 61" Oyster White Louvered Panel	1	21 lbs
QLP-3619HC	36" x 19" Oyster White Louvered Panel	1	13 lbs
QLP-3661HC	36" x 61" Oyster White Louvered Panel	1	40 lbs
QLP-4861HC	48" x 61" Oyster White Louvered Panel	1	60 lbs
Gray Wall Mounted Louvered Panels			
QLP-1819	18" x 19" Gray Louvered Panel	1	6 lbs
QLP-1861	18" x 61" Gray Louvered Panel	1	21 lbs
QLP-2721	27" x 21" Gray Louvered Panel	1	11 lbs
QLP-3612	36" x 12" Gray Louvered Panel	1	8 lbs
QLP-3619	36" x 19" Gray Louvered Panel	1	13 lbs
QLP-3661	36" x 61" Gray Louvered Panel	1	40 lbs
QLP-4819	48" x 19" Gray Louvered Panel	1	18 lbs
QLP-4861	48" x 61" Gray Louvered Panel	1	60 lbs

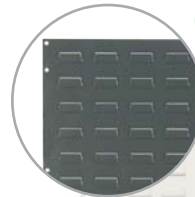

OYSTER WHITE OR GRAY
color!



QLP-4861HC
48" L x 61" H

Accepts all sizes of Ultra Bins.
500 lbs. load capacity. (Bins sold separately)

QUANTITY OF ULTRA BINS TO FIT LOUVERED PANELS

MODEL NO.	QUS 200	QUS 210	QUS 220	QUS 221	QUS 224	QUS 230	QUS 234	QUS 235	QUS 239	QUS 240	QUS 241	QUS 242	QUS 245	QUS 250	QUS 255	QUS 260	QUS 265	QUS 270
QLP-1819	16	16	16	9	12	9	9	3	4	4	4	4	3	2	1	1	4	1
QLP-1861	60	60	60	30	30	30	30	15	14	14	14	14	10	7	7	5	12	5
QLP-2721	30	30	30	12	12	12	12	6	6	6	6	6	3	2	4	4	6	1
QLP-3612	18	18	18	12	12	12	12	6	4	4	4	4	4	2	6	3	8	2
QLP-3619	40	40	40	18	24	18	18	9	8	8	8	8	6	4	6	3	8	2
QLP-3661	120	120	120	60	80	60	60	30	28	28	28	28	20	14	21	15	24	10
QLP-4819	55	55	55	24	24	24	24	12	10	10	10	10	6	4	8	8	10	2
QLP-4861	165	165	165	80	80	80	80	40	35	35	35	35	20	14	28	20	30	10

See pg. 88 for bin dimensions.



Hang-n-Stack Bins - Complete Packages

Comes with 2 handy 12" plastic rails ideal for mounting to any surface. Bins can hang or stack securely providing an efficient bin storage system. Available in Blue, Green, Ivory, Red, Yellow, Black and Clear. Rails available in White.

Available in: ● Blue ● Green ● Ivory ● Red ● Yellow
● Black ● Clear

MODEL NO.	BIN DIMENSIONS L" x W" x H"	DESCRIPTION	CTN WGT
HNS200	5" x 4-1/8" x 3"	6 bins + 2 rails	2 lbs
HNS210	5-3/8" x 4-1/8" x 3"	6 bins + 2 rails	2 lbs
HNS220	7-3/8" x 4-1/8" x 3"	6 bins + 2 rails	3 lbs
HNS230	10-7/8" x 5-1/2" x 5"	4 bins + 2 rails	5 lbs
HNS006	Extra Rails	2 rails	1 lb

CUSTOMIZE YOUR OWN UNIT!

1. Select the hanging unit of your choice.
2. Turn to pg. 88 and choose the bin that best fits your need.
3. Go to the chart at the bottom of this page and determine how many bins fit on the unit you selected.
4. Place your order for both unit and bins. (Bins sold in carton quantities)

Ultra Rail Systems

Rails may be mounted on any suitable surface including walls, benches, inside service trucks and cabinets or on carts. Fasten securely to assure proper load bearing. Configure Rail System to meet your custom requirements. (Bins sold separately)



Steel Rail

48"L x 3"H Steel Rail mounts to any surface or workbench and accepts 13 sizes of Ultra Bins (up to 11 bins per rail). 125 lb. load capacity. (Bins sold separately)

MODEL NO.	DESCRIPTION	CTN QTY	CTN WGT
QRU-1W	48" Wall Rail	1	6 lbs



Shown here with 48 QUS230 bins. (Bins sold separately)

**QRU-16S
Single Sided Rack, 16 Rails**

36"L x 15"W x 53"H
Accepts 6 sizes of Ultra Bins (up to 48 bins)
600 lb. capacity. See chart for bin configurations. (Bins sold separately)

QRU-12S

Single Sided Rack, 12 Rails
Accepts 12 sizes of Ultra Bins (up to 96 bins)
600 lb. capacity. See chart for bin configurations. (Bins sold separately)



Shown here with 192 QUS220 bins. (Bins sold separately)

**QRU-12D
Double Sided Rack, 12 Rails**

36"L x 20"W x 53"H
Accepts 12 sizes of Ultra Bins (up to 192 bins)
1,600 lb. capacity. See chart for bin configurations. (Bins sold separately)

QRU-16D

Double Sided Rack, 16 Rails
Accepts 6 sizes of Ultra Bins (up to 96 bins)
1,600 lb. capacity. See chart for bin configurations. (Bins sold separately)



Shown here with 96 QUS230 bins. (Bins sold separately)

**QRU-16D + QRU-MOB
Double Sided Rack, 16 Rails with Mobile Kit**

36"L x 20"W x 59"H
Accepts 6 sizes of Ultra Bins (up to 96 bins)
500 lb. capacity. See chart for bin configurations. (Bins sold separately)

QRU-12D + QRU-MOB

Double Sided Rack, 12 Rails with Mobile Kit
Accepts 12 sizes of Ultra Bins (up to 192 bins)
500 lb. capacity. See chart for bin configurations. (Bins sold separately)

QUANTITY OF ULTRA BINS TO FIT RAIL UNITS

MODEL NO.	DESCRIPTION	DIMENSIONS L" x W" x H"	QUS 200	QUS 210	QUS 220	QUS 221	QUS 224	QUS 230	QUS 234	QUS 235	QUS 239	QUS 240	QUS 241	QUS 242	QUS 245	QUS 250	QUS 255	QUS 260	QUS 265	QUS 270
QRU-1W	48"L Steel Rail	48" x - x 3"	11	11	11	8	11	8	8	4	5	5	5	5	3	-	-	-	-	-
QRU-12S	Rack, 1 sided 12 rail	36" x 15" x 53"	96	96	96	-	-	-	-	-	24	24	24	20	-	12	12	20	8	8
QRU-16S	Rack, 1 sided 16 rail	36" x 15" x 53"	-	-	-	48	48	48	48	24	-	-	-	-	16	-	-	-	-	-
QRU-12D	Rack, 2 sided 12 rail	36" x 20" x 53"	192	192	192	-	-	-	-	-	48	48	48	40	-	24	24	24	40	16
QRU-16D	Rack, 2 sided 16 rail	36" x 20" x 53"	-	-	-	96	96	96	96	48	-	-	-	-	32	-	-	-	-	-

QRU-MOB Mobilizes Double Sided Units

See pg. 88 for bin dimensions.

Stackable Shelf Bins



Quantum's exclusive Stackable Shelf Bins are an industry first and are ideal for medium size and large or heavy item storage. These strong, durable polypropylene bins are available in 4 lengths and 3 widths. 12", 14" and 18" deep bins have a built in rear hanger which allows bin to hang from louvered panels and rails. Bins have a raised front opening when compared to any like product allowing you to truly maximize the complete bin's storage capacity. Optional cross dividers allow flexibility and keep parts organized. Waterproof bins resist rust and corrosion. Large molded in front label slots for ID labels. Autoclavable up to 250°F and resistant to extreme cold. Available in 5 colors.



STACKABLE SHELF BIN

Available in: ● Blue ● Ivory ● Black ● Gray ● Orange

MODEL NO.	OUTSIDE DIMENSIONS L" x W" x H"	INSIDE DIMENSIONS L" x W" x H"	CTN QTY	CTN WGT	DIVIDER	CTN QTY	CTN WGT
SSB423	12" x 8-1/4" x 7"	11-1/2" x 7-3/8" x 6-1/2"	6	9	DSS403	6	1
SSB425	12" x 11" x 7"	11-1/2" x 10-1/8" x 6-1/2"	6	10	DSS405	6	2
SSB441	14" x 6" x 7"	13-1/2" x 5-3/8" x 6-1/2"	6	10	DSS401	6	1
SSB443	14" x 8-1/4" x 7"	13-1/2" x 7-3/8" x 6-1/2"	12	21	DSS403	6	1
SSB445	14" x 11" x 7"	13-1/2" x 10-1/8" x 6-1/2"	6	12	DSS405	6	2
SSB461	18" x 6" x 7"	17-1/2" x 5-3/8" x 6-1/2"	6	16	DSS401	6	1
SSB463	18" x 8-1/4" x 7"	17-1/2" x 7-3/8" x 6-1/2"	6	18	DSS403	6	1
SSB465	18" x 11" x 7"	17-1/2" x 10-1/8" x 6-1/2"	6	20	DSS405	6	2
SSB483	20-1/2" x 8-1/4" x 7"	20" x 7-3/8" x 6-1/2"	6	20	DSS403	6	1
SSB485	20-1/2" x 11" x 7"	20" x 10-1/8" x 6-1/2"	6	27	DSS405	6	2

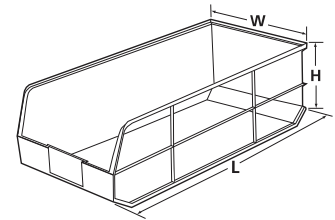

Bin Dimensions Guide
L (length) W (width) H (height)

10 SIZES AND 5 COLORS AVAILABLE!



SSB423



SSB425



SSB441



SSB443



SSB445



SSB461



SSB463



SSB465



SSB483



SSB485

PERFORMANCE FEATURES AT A GLANCE:

- Available in 10 sizes
- Standard colors: Blue, Ivory, Black, Gray and Orange (additional colors available on request, subject to up charge and minimum runs)
- Bins are made from heavy-duty, virgin, high density FDA approved polypropylene
- Large label slots provide easy label insertion and parts identification
- Extra wide stacking ledge assures stability for high stacking
- Reinforced design adds strength and prevents spreading
- Will not rust or corrode, unaffected by weak acids and alkalis, and are waterproof
- Autoclavable up to 250°F
- Interchangeable with other manufactured brands of bins



LTR-2400 Clear Label Holder
Clear label holders and laser label inserts. Package of 25.



SSB425
Shown with optional Divider DSS405 (Sold separately)



Stackable Shelf Bin Wire Shelving Systems - Complete Packages



WR8-461
18"W x 36"L x 74"H
8 shelves and 35 **SSB461**
18"L x 6"W x 7"H bins



WR8-463
18"W x 36"L x 74"H
8 shelves and 28 **SSB463**
18"L x 8-1/4"W x 7"H bins



WR8-485
21"W x 36"L x 74"H
8 shelves and 21 **SSB485**
20-1/2"L x 11"W x 7"H bins



MOBILIZE YOUR WIRE SHELVING

DB - Donut Bumper
Non-marking donut bumper used to protect walls and help cushion impact.

WR-00H (Mobile Kit)*
Set of four swivel polyurethane 5" x 1-1/4" casters, two with brakes. Can be used with all units shown. 1,200 lb. load capacity. *Mobile kits recommended only for shelves 18" and wider.

COMPLETE PACKAGES with bins!



Available Wire Units Finishes
Chrome, Stainless Steel and Proform

MODEL NO.	OUTSIDE DIMENSIONS W" x L" x H"	NO. OF SHELVES	NO. OF BINS	BIN DIMENSIONS L" x W" x H"	SHIP WGT
WR8-423	12" x 36" x 74"	8	28 SSB423	12" x 8-1/4" x 7"	114
WR8-425	12" x 36" x 74"	8	21 SSB425	12" x 11" x 7"	107
WR8-441	14" x 36" x 74"	8	35 SSB441	14" x 6" x 7"	136
WR8-443	14" x 36" x 74"	8	28 SSB443	14" x 8-1/4" x 7"	129
WR8-445	14" x 36" x 74"	8	21 SSB445	14" x 11" x 7"	122
WR8-461	18" x 36" x 74"	8	35 SSB461	18" x 6" x 7"	190
WR8-463	18" x 36" x 74"	8	28 SSB463	18" x 8-1/4" x 7"	180
WR8-465	18" x 36" x 74"	8	21 SSB465	18" x 11" x 7"	184
WR8-483	21" x 36" x 74"	8	28 SSB483	20-1/2" x 8-1/4" x 7"	198
WR8-483485	21" x 36" x 74"	8	12 SSB483 12 SSB485	20-1/2" x 8-1/4" x 7" 20-1/2" x 11" x 7"	199
WR8-485	21" x 36" x 74"	8	21 SSB485	20-1/2" x 11" x 7"	198



HULK 24" Containers



Organize and store your large and bulky items with these strong injection molded polypropylene, stackable containers. These extra large stacking containers offer a generous 2 feet in length to store your larger items. These huge stack bins are ideal for heavy-duty, extra deep shelving and are available in a variety of widths and heights. Heavy-duty front, back and side grips allow for easy handling. Optional clear styrene plastic window increases bin capacity and provides a quick view of the bin contents. Optional dividers maximize flexibility and keep contents organized. Wide stacking ledge and anti-slide lock keep stacked bins steady and prevent forward shifting. Waterproof bins are corrosion free. Bins are autoclavable up to 250°F and are resistant to extreme cold. Available in 4 colors. See pg. 81 to order Clear bins.



HULK
containers

CLEAR VIEW
BINS

AVAILABLE on pg. 81

Available in: ● Blue ● Red ● Yellow ● Clear

MODEL NO.	OUTSIDE DIMENSIONS L" x W" x H"	INSIDE DIMENSIONS L" x W" x H"	X"	CTN QTY	CTN WGT	CLEAR WINDOW	CTN QTY	DIVIDER	CTN QTY
QUS950	23-7/8" x 8-1/4" x 7"	21-7/8" x 6-1/4" x 6-5/8"	19"	6	18 lbs	WUS950/970	6	DUS950	6
QUS951	23-7/8" x 8-1/4" x 9"	21-7/8" x 6-1/4" x 8-3/4"	18-3/4"	6	21 lbs	WUS951	6	DUS951	6
QUS952	23-7/8" x 11" x 7"	21-7/8" x 9" x 6-7/8"	19"	4	14 lbs	WUS952	4	DUS952	6
QUS953	23-7/8" x 11" x 10"	21-1/2" x 8-7/8" x 9-3/4"	18-3/4"	4	18 lbs	WUS953/973	4	DUS953	6
QUS954	23-7/8" x 16-1/2" x 11"	21-7/8" x 14-1/4" x 10-3/4"	18-3/4"	1	7 lbs	WUS954/974	1	DUS954	6
QUS964MOB	23-7/8" x 16-1/2" x 11"	21-7/8" x 14-1/4" x 10-3/4"	18-3/4"	1	9 lbs	WUS954/974	1	DUS954	6
QUS955	23-7/8" x 18-1/4" x 12"	21-1/2" x 16" x 11-3/4"	17-3/4"	1	8 lbs	WUS955/975	1	DUS955	6
QUS965MOB	23-7/8" x 18-1/4" x 12"	21-1/2" x 16" x 11-3/4"	17-3/4"	1	10 lbs	WUS955/975	1	DUS955	6

* With caster, overall height for mobile container will be increased by 3"

8 SIZES AND 4 COLORS AVAILABLE!



QUS950



QUS951



QUS952



QUS953



QUS954



QUS955



QUS964MOB



QUS965MOB



QUS965MOB

Mobile HULK Container

Ideal for transport of heavy and bulky parts. Bin comes with 4 swivel, 3" casters, all with brakes, allowing up to 250 lb. mobile load capacity.



QUS953

Shown with optional Divider and Window (Sold separately)



DLY-3018

Polymer Mobile Dolly

DLY-3018 Dolly with Padded Rubber Trim, available in Blue. 1,000 lbs. capacity. Exterior Dimensions 30"L x 18"W



ATTACHED PULL RING allows dolly to be pulled with ease



HULK 24" Container Wire Shelving Systems - Complete Packages



WR8-950
24"W x 36"L x 74"H
8 shelves and 28 QUS950
23-7/8"L x 8-1/4"W x 7"H bins



WR7-951
24"W x 36"L x 74"H
7 shelves and 24 QUS951
23-7/8"L x 8-1/4"W x 9"H bins



WR8-952
24"W x 36"L x 74"H
8 shelves and 21 QUS952
23-7/8"L x 11"W x 7"H bins



WR6-953
24"W x 36"L x 74"H
6 shelves and 15 QUS953
23-7/8"L x 11"W x 10"H bins



WR6-954
24"W x 36"L x 74"H
6 shelves and 10 QUS954
23-7/8"L x 16-1/2"W x 11"H bins



WR5-955
24"W x 42"L x 74"H
5 shelves and 8 QUS955
23-7/8"L x 18-1/4"W x 12"H bins



WR8-950952
24"W x 36"L x 74"H
8 shelves and 12 QUS950
23-7/8"L x 8-1/4"W x 7"H bins
and 12 QUS952
23-7/8"L x 11"W x 7"H bins



WR7-20-MIX
24"W x 36"L x 74"H
7 shelves and 8 QUS950
23-7/8"L x 8-1/4"W x 7"H bins
and 3 QUS952
23-7/8"L x 11"W x 7"H bins
and 4 QUS951
23-7/8"L x 8-1/4"W x 9"H bins
and 3 QUS953
23-7/8"L x 11"W x 10"H bins
and 2 QUS954
23-7/8"L x 16-1/2"W x 11"H bins



MOBILIZE YOUR WIRE SHELVING

DB - Donut Bumper
Non-marking donut bumper used to protect walls and help cushion impact.

WR-00H (Mobile Kit)*
Set of four swivel polyurethane 5" x 1-1/4" casters, two with brakes. Can be used with all units shown. 1,200 lb. load capacity. *Mobile kits recommended only for shelves 18" and wider.

800 lb.
capacity per shelf!



AVAILABLE on pg. 81

HULK 30" & 36" Containers



LARGEST & TOUGHEST BINS available in the industry!

Organize and store your large and bulky items with these strong injection molded high impact polypropylene, stackable containers. These extra large stacking containers offer a generous 2-1/2 - 3 feet in length to store your larger items. These huge stack bins are ideal for heavy-duty, extra deep shelving and are available in a variety of widths and heights. Heavy-duty front, back and side grips allow for easy handling. Wide stacking ledge and anti-slide lock keep stacked bins steady and prevent forward shifting. Waterproof bins are corrosion-free. Bins are autoclavable up to 250°F and are resistant to extreme cold. Available in 3 colors.



HULK containers

8 SIZES AND 3 COLORS AVAILABLE!



QUS970

QUS973

QUS974

QUS975

QUS976

QUS984MOB

QUS985MOB

QUS986MOB

HULK 30" Containers

Available in: ● Blue ● Red ● Yellow

MODEL NO.	OUTSIDE DIMENSIONS L" x W" x H"	INSIDE DIMENSIONS L" x W" x H"	X"	CTN QTY	CTN WGT	CLEAR WINDOW	CTN QTY	DIVIDER	CTN QTY
QUS970	29-7/8" x 8-1/4" x 7"	27-7/8" x 6-1/4" x 6-3/4"	25"	6	23 lbs	WUS950/970	6	DUS970	6
QUS973	29-7/8" x 11" x 10"	27-7/8" x 8-7/8" x 9-5/8"	24-3/4"	4	22 lbs	WUS953/973	4	DUS973	4
QUS974	29-7/8" x 16-1/2" x 11"	27-5/8" x 14-1/4" x 10-5/8"	24-3/4"	1	8 lbs	WUS954/974	1	DUS974	1
QUS984MOB	29-7/8" x 16-1/2" x 11"	27-5/8" x 14-1/4" x 10-5/8"	24-3/4"	1	10 lbs	WUS954/974	1	DUS974	1
QUS975	29-7/8" x 18-1/4" x 12"	27-1/2" x 16" x 11-3/4"	23-3/4"	1	9 lbs	WUS955/975	1	DUS975	1
QUS985MOB	29-7/8" x 18-1/4" x 12"	27-1/2" x 16" x 11-3/4"	23-3/4"	1	11 lbs	WUS955/975	1	DUS975	1
QUS976	29-7/8" x 16-1/2" x 15"	27-3/8" x 14" x 14-3/4"	23-1/2"	1	10 lbs	WUS976	1	DUS976	1
QUS986MOB	29-7/8" x 16-1/2" x 15"	27-3/8" x 14" x 14-3/4"	23-1/2"	1	12 lbs	WUS976	1	DUS976	1

* With casters, overall height for mobile container will be increased by 3"



Clear Plastic Window
Increases bin capacity and provides a quick view of the bin contents. (Sold separately)

6 SIZES AND 3 COLORS AVAILABLE!



QUS993

QUS994MOB

QUS995

QUS996MOB

QUS997

HULK 36" Containers

Available in: ● Blue ● Red ● Yellow

MODEL NO.	OUTSIDE DIMENSIONS L" x W" x H"	INSIDE DIMENSIONS L" x W" x H"	X"	CTN QTY	CTN WGT	DIVIDER	CTN QTY
QUS993	35-7/8" x 16-1/2" x 17-1/2"	33-1/8" x 14" x 17-1/4"	28-1/4"	1	14 lbs	DUS993	1
QUS994MOB	35-7/8" x 16-1/2" x 17-1/2"	33-1/8" x 14" x 17-1/4"	28-1/4"	1	17 lbs	DUS993	1
QUS995	35-7/8" x 19-7/8" x 17-1/2"	33-1/8" x 17-3/8" x 17-1/4"	28-1/4"	1	15 lbs	DUS995	1
QUS996MOB	35-7/8" x 19-7/8" x 17-1/2"	33-1/8" x 17-3/8" x 17-1/4"	28-1/4"	1	17 lbs	DUS995	1
QUS997	35-7/8" x 23-7/8" x 17-1/2"	33-1/4" x 21-3/8" x 17-1/4"	28-1/4"	1	18 lbs	DUS997	1
QUS998MOB	35-7/8" x 23-7/8" x 17-1/2"	33-1/4" x 21-3/8" x 17-1/4"	28-1/4"	1	20 lbs	DUS997	1

* Overall height for mobile container will be increased by 3"

SIZE does matter!



QUS998MOB



HULK 30" Container Wire Shelving Systems - Complete Packages



WR8-970
30"W x 36"L x 74"H
8 shelves and 28 QUS970
29-7/8"L x 8-1/4"W x 7"H bins



WR6-973
30"W x 36"L x 74"H
6 shelves and 15 QUS973
29-7/8"L x 11"W x 10"H bins



WR6-974
30"W x 36"L x 74"H
6 shelves and 10 QUS974
29-7/8"L x 16-1/2"W x 11"H bins



WR5-975
30"W x 42"L x 74"H
5 shelves and 8 QUS975
29-7/8"L x 18-1/4"W x 12"H bins

**QUANTUM CHROME
WIRE SHELVING
SYSTEMS**

complete with containers!

**HULK
containers**

700 lb.
capacity per shelf!



WR6-973974
30"W x 36"L x 74"H
6 shelves and 9 QUS973
29-7/8"L x 11"W x 10"H bins
and 4 QUS974
29-7/8"L x 16-1/2"W x 11"H bins



MOBILIZE YOUR WIRE SHELVING

DB - Donut Bumper

Non-marking donut bumper used to protect walls and help cushion impact.

WR-00H (Mobile Kit)*

Set of four swivel polyurethane 5" x 1-1/4" casters, two with brakes. Can be used with all units shown. 1,200 lb. load capacity. *Mobile kits recommended only for shelves 18" and wider.

HULK 36" Container Wire Shelving Systems - Complete Packages



WR5-993
36"W x 36"L x 86"H
5 shelves and 8 QUS993
35-7/8"L x 16-1/2"W x 17-1/2"H bins

**QUANTUM
CHROME WIRE
SHELVING SYSTEMS**
complete with containers!

600 lb.
capacity per shelf!



WR5-995
36"W x 48"L x 86"H
5 shelves and 8 QUS995
35-7/8"L x 19-7/8"W x 17-1/2"H bins

HULK
containers



SIZE
does matter!



MOBILIZE YOUR WIRE SHELVING

DB - Donut Bumper

Non-marking donut bumper used to protect walls and help cushion impact.

WR-00H (Mobile Kit)*

Set of four swivel polyurethane 5" x 1-1/4" casters, two with brakes. Can be used with all units shown. 1,200 lb. load capacity. *Mobile kits recommended only for shelves 18" and wider.



WR5-997
36"W x 60"L x 86"H
5 shelves and 8 QUS997
35-7/8"L x 23-7/8"W x 17-1/2"H bins

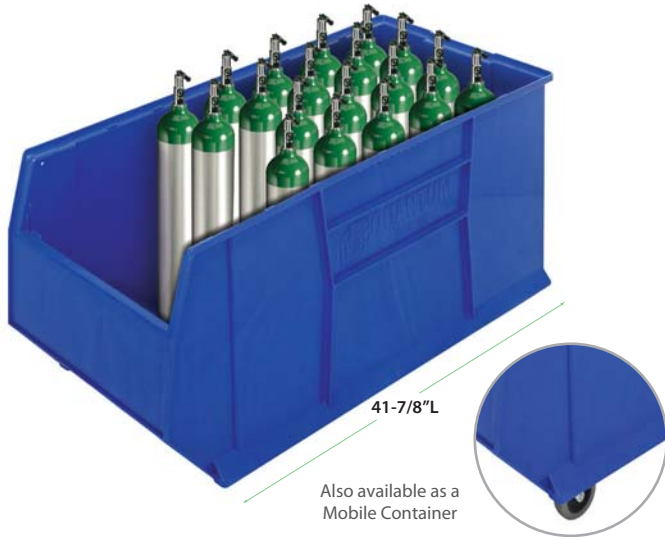

Also available as a Mobile Container

THE FIRST & ONLY BIN DESIGNED
specifically to fit pallet rack!

RACKBIN 42" Containers



- These extra large bins offer a generous 42" (3-1/2 Feet) in length to store your larger items
- 42" length ensures no wasted space on 42" deep rack
- Heavy-duty front, back and side grips allow for easy handling
- Wide stacking ledge and anti-slide lock keep stack bins steady and prevent forward shifting
- Have eight 1/4" drill hole pattern on bottom of bin for easy hole insertion for drainage and air circulation if needed
- Waterproof bins are corrosion free
- Available in 2 colors

Available in: ● Blue ● Gray

MODEL NO.	OUTSIDE DIMENSIONS L" x W" x H"	INSIDE DIMENSIONS L" x W" x H"	X	CTN QTY	CTN WGT
QRB166	41-7/8" x 16-1/2" x 17-1/2"	40-1/8" x 14" x 16-1/2"	35"	1	16 lbs
QRB176MOB	41-7/8" x 16-1/2" x 17-1/2"*	40-1/8" x 14" x 16-1/2"	35"	1	18 lbs
QRB206	41-7/8" x 19-7/8" x 17-1/2"	40-1/8" x 17-3/8" x 16-1/2"	35"	1	17 lbs
QRB216MOB	41-7/8" x 19-7/8" x 17-1/2"*	40-1/8" x 17-3/8" x 16-1/2"	35"	1	19 lbs
QRB246	41-7/8" x 23-7/8" x 17-1/2"	40-1/8" x 21-1/2" x 16-1/2"	35"	1	19 lbs
QRB256MOB	41-7/8" x 23-7/8" x 17-1/2"*	40-1/8" x 21-1/2" x 16-1/2"	35"	1	21 lbs

* With casters, overall height for mobile container will be increased by 3"



WRA86-2142C-206

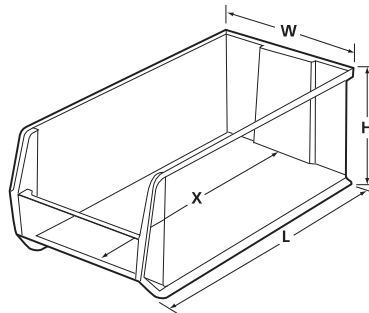

Bin Dimensions Guide
L (length) W (width) H (height)
X (inside length)

COMPLETE PACKAGES
with containers!

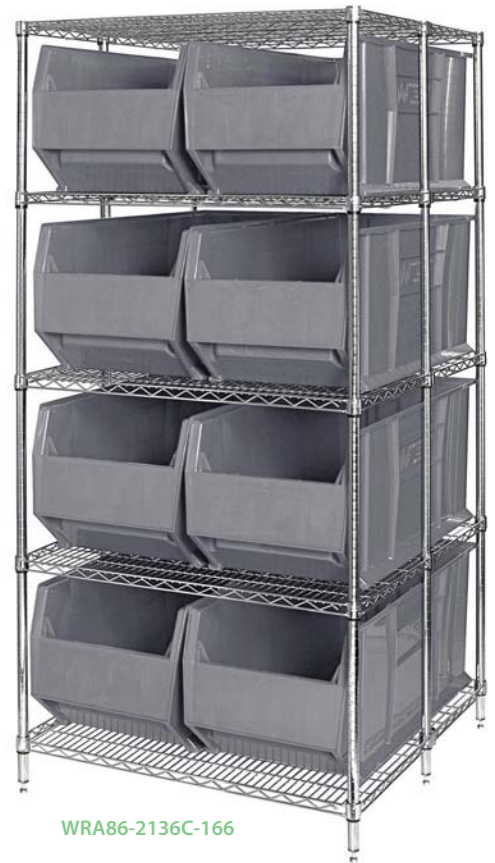

WRA86-2136C-166

MODEL NO.	DIMENSIONS W" x L" x H"	NO. OF CONTAINERS	CONTAINER SIZE L" x W" x H"	SHIP WGT
WRA86-2136C-166	42" x 36" x 86"	8 QRB166	41-7/8" x 16-1/2" x 17-1/2"	272 lbs
WRA86-2142C-206	42" x 42" x 86"	8 QRB206	41-7/8" x 19-7/8" x 17-1/2"	290 lbs
WRA86-2148C-246	42" x 48" x 86"	8 QRB246	41-7/8" x 23-7/8" x 17-1/2"	326 lbs
WRA86-2154C-166	42" x 54" x 86"	12 QRB166	41-7/8" x 16-1/2" x 17-1/2"	386 lbs
WRA86-2172C-246	42" x 72" x 86"	12 QRB246	41-7/8" x 23-7/8" x 17-1/2"	502 lbs



Giant Stack & Stock Containers



Multipurpose, wide open hopper front provides easy access for large part storage. Ideal for multiple applications in recycling, storing parts and components. This bin will stack up to 6 bins high creating a sturdy, tall storage system. Bins are injection molded from high density polypropylene, easy to clean, resist corrosion and are impervious to most chemicals. Large label holder allows for quick identification. Optional clear window increases storage capacity and allows for quick identification of parts. Six 1/4" drill hole pattern on bottom of bin allow for easy hole insertion for drainage and air circulation. See pg. 83 to order Clear Bins.



Curved lip and corners provide added strength

Large and comfortable grip side handles allow for easy carrying and handling

Large label holder allows for quick part identification

Ribs on side of bin provide added stability when stacked



Clear Plastic Window increases bin capacity and provides a quick view of the bin contents. (Sold separately)



QGH600



QGH700



QGH800



QGH700CL



AVAILABLE on pg. 83

QGH700 available in: ● Blue ● Ivory ● Red ● Black ● Gray ● Clear

QGH600 and QGH800 available in: ● Blue ● Red ● Gray ● Clear

MODEL NO.	OUTSIDE DIMENSIONS L" x W" x H"	INSIDE DIMENSIONS L" x W" x H"	X"	CAP CU FT	CTN QTY	CTN WGT	WINDOW	CTN QTY
QGH600	17-1/2" x 10-7/8" x 12-1/2"	15-5/8" x 8" x 12-1/4"	13-1/2"	0.98	4	12 lbs	WGH600	4
QGH700*	15-1/4" x 19-7/8" x 12-7/16"	13-5/8" x 17-1/2" x 12-1/4"	11-1/2"	1.7	3	13 lbs	WGH700	3
QGH800	17-1/2" x 16-1/2" x 12-1/2"	15-5/8" x 13-3/4" x 12-1/4"	13-1/2"	1.6	2	8 lbs	WGH800	2

*Optional label for QGH700 is available, LGH700 (3 per package)

Mobile Giant Stack & Stock Containers



- Ideal for transport of heavy and bulky parts
- Container comes with 4 swivel, 3" casters, all with brakes, allowing for up to 250 lb. mobile load capacity
- Containers can stack with casters in place



QGH705MOB



QGH805MOB

QGH705MOB available in: ● Blue ● Ivory ● Red ● Black ● Gray ● Clear

QGH805MOB available in: ● Blue ● Red ● Gray ● Clear

MODEL NO.	OUTSIDE DIMENSIONS L" x W" x H"	INSIDE DIMENSIONS L" x W" x H"	X"	CAP CU FT	CTN QTY	CTN WGT	WINDOW	CTN QTY
QGH705MOB	15-1/4" x 19-7/8" x 12-7/16"	13-5/8" x 17-1/2" x 12-1/4"	11-1/2"	1.7	3	22 lbs	WGH700	3
QGH805MOB	17-1/2" x 16-1/2" x 12-1/2"	15-5/8" x 13-3/4" x 12-1/4"	13-1/2"	1.6	2	17 lbs	WGH800	2

* With casters, overall height for mobile container will be increased by 3"



PERFORMANCE FEATURES AT A GLANCE:

- Extra thick side walls with reinforced rib designed for strength, allowing for 100 lb. stack capacity per bin
- Large grip side handles
- Stacks 6 bins high
- Six 1/4" drill hole pattern on bottom of bin allows for easy hole insertion for drainage

Giant Stack & Stock Container Wire Shelving Systems - Complete Packages



WR5-600
18"W x 36"L x 74"H
5 shelves and 12 QGH600
17-1/2"L x 10-7/8"W x 12-1/2"H bins



WR5-700
18"W x 42"L x 74"H
5 shelves and 8 QGH700
15-1/4"L x 19-7/8"W x 12-7/16"H bins

COMPLETE PACKAGES
with containers!



MOBILIZE YOUR WIRE SHELVING

DB - Donut Bumper
Non-marking donut bumper used to protect walls and help cushion impact.

WR-00H (Mobile Kit)*
Set of four swivel polyurethane 5" x 1-1/4" casters, two with brakes. Can be used with all units shown. 1,200 lb. load capacity. *Mobile kits recommended only for shelves 18" and wider.



WR5-800
18"W x 36"L x 74"H
5 shelves and 8 QGH800
17-1/2"L x 16-1/2"W x 12-1/2"H bins



AVAILABLE on pg. 83

800 lb.
capacity per shelf!



WR5-600800
18"W x 36"L x 74"H
5 shelves and 6 QGH600 17-1/2"L x 10-7/8"W x 12-1/2"H bins
and 4 QGH800 17-1/2"L x 16-1/2"W x 12-1/2"H bins

MAGNUM Bins - Super Strong and Durable!



Heavy-duty, extra strong injection molded, high density polypropylene bins are ideal for transportation and storage of large and heavy components. Open hopper front allows immediate access and visibility. Ribbed reinforced walls ensure extra strength. Double wall thickness with preformed lip allows bin to interlock and provides up to 150 lbs. stack capacity. Transport these bins easily with rear molded handle. Molded in label slot. Impervious to most solvents and corrosion. Resists temperatures from -40°F to 250°F. Optional window maximizes storage and prevents spillage. Optional dividers can help in creating a Par Level Storage System. Available in 5 colors.



Available in: ● Blue ● Green ● Red ● Yellow ● Black

MODEL NO.	OUTSIDE DIMENSIONS L" x W" x H"	INSIDE DIMENSIONS L" x W" x H"	CTN QTY	CTN WGT	DIVIDERS	CTN QTY	WINDOWS	CTN QTY
QMS531	19-3/4" x 12-3/8" x 5-7/8"	17-3/4" x 11-1/4" x 5-1/8"	6	19 lbs	DMS531	6	WMS531	6
QMS532	19-3/4" x 12-3/8" x 7-7/8"	17-3/4" x 11-1/4" x 7-1/4"	6	23 lbs	DMS532	6	WMS532	6
QMS533	19-3/4" x 12-3/8" x 11-7/8"	17-3/4" x 11-1/4" x 11"	3	15 lbs	DMS533	3	WMS533	3
QMS543	19-3/4" x 18-3/8" x 11-7/8"	17-3/4" x 17-1/4" x 11"	1	8 lbs	DMS543	1	WMS543	1
QMS743*	29" x 18-3/8" x 11-7/8"	26-3/4" x 17-1/4" x 11"	1	10 lbs				
QMS843MOB*	29" x 18-3/8" x 14-7/8"	26-3/4" x 17-1/4" x 11"	1	14 lbs				

* Includes Heavy-Duty spread bar for extra strength and support.

PERFORMANCE FEATURES AT A GLANCE:

- Available in 5 sizes and 5 colors (Blue, Green, Red, Yellow and Black) for inventory control and color code efficiency
- These heavy-duty containers are injection molded from high density polypropylene and are ideal for storage and transport of large parts
- Extra heavy, double wall thickness with interlock preformed lips allow containers to stack securely (Bins sold in carton quantities)

6 SIZES AND 5 COLORS AVAILABLE!



QMS531



QMS532



QMS533



QMS543



QMS743



QMS843MOB

MAGNUM



QMS743
Shown stacked on
QMS843MOB



Clear Plastic Window
Increases bin capacity and provides a quick view of the bin contents. (Sold separately)



QMS531
Shown with optional Divider (Sold separately)

Heavy-duty spread bar for extra strength and support

Polymer Mobile Dolly

DLY-3018 Dolly with Padded Rubber Trim available in Blue. 1,000 lbs. capacity. Interior Dimensions 24"L x 16-3/4"W Exterior Dimensions 30"L x 18"W

MODEL NO.	DESCRIPTION	CTN WGT
DLY-3018	Dolly with Padded Rubber Trim	19 lbs
HANDLE-DLY	32" Dolly Pull Rod with Handle	2 lbs

Bins sold separately.



DLY-3018 and QMS743



ATTACHED PULL RING
allows dolly to be pulled with ease

Mobile MAGNUM Bins

- Bin comes with 4 swivel 3" casters, all with brakes, allowing for 300 lb. mobile capacity
- Bins can stack on each other with casters in place
- **QMS843MOB** includes heavy-duty spread bar

MAGNUM Bin Wire Shelving Systems - Complete Packages



800 lb.
capacity per shelf!



WR9-531
18"W x 42"L x 74"H
9 shelves and 24 QMS531
19-3/4"L x 12-3/8"W x 5-7/8"H bins



WR6-13-MIX
18"W x 42"L x 74"H
6 shelves and 4 QMS543
19-3/4"L x 18-3/8"W x 11-7/8"H bins
3 QMS533
19-3/4"L x 12-3/8"W x 11-7/8"H bins
3 QMS532
19-3/4"L x 12-3/8"W x 7-7/8"H bins
3 QMS531
19-3/4"L x 12-3/8"W x 5-7/8"H bins



MOBILIZE YOUR WIRE SHELVING

DB - Donut Bumper
Non-marking donut bumper used to protect walls and help cushion impact.

WR-00H (Mobile Kit)*
Set of four swivel polyurethane 5" x 1-1/4" casters, two with brakes. Can be used with all units shown. 1,200 lb. load capacity. *Mobile kits recommended only for shelves 18" and wider.



COMPLETE PACKAGES
with bins!



WR7-532
18"W x 42"L x 74"H
7 shelves and 18 QMS532
19-3/4"L x 12-3/8"W x 7-7/8"H bins



WR5-533
18"W x 42"L x 74"H
5 shelves and 12 QMS533
19-3/4"L x 12-3/8"W x 11-7/8"H bins



WR5-543
18"W x 42"L x 74"H
5 shelves and 8 QMS543
19-3/4"L x 18-3/8"W x 11-7/8"H bins



Economy Shelf Bins



Quantum's tough, durable, high density Economy Shelf Bins are the industry standard for quality. These durable polypropylene bins feature a molded-in label holder, built-in rear hanglock which allows bins to tilt out for complete access when on shelving. A wide hopper front allows complete access to the contents of the bin. Edges are reinforced for added strength. They are designed for 12", 18" and 24" deep shelf units, racks or standard shelving. Bins are impervious to most chemicals. Available in 7 colors. See pg. 84 to order Clear Bins.



Available in: ● Blue ● Green ● Ivory ● Red ● Yellow ● Black ● Clear

MODEL NO.	OUTSIDE DIMENSIONS L" x W" x H"	INSIDE DIMENSIONS L" x W" x H"	CTN QTY	CTN WGT	DIVIDER	CTN QTY	NO. OF BIN CUPS PER BIN	
							QBC111	QBC112
QSB100	11-5/8" x 2-3/4" x 4"	10-1/4" x 1-5/8" x 4"	36	13 lbs	-	-	3	0
QSB101	11-5/8" x 4-1/8" x 4"	10-1/4" x 3" x 4"	36	17 lbs	DSB101	50	6	2
QSB102	11-5/8" x 6-5/8" x 4"	10-1/4" x 5-1/2" x 4"	30	18 lbs	DSB102	50	9	4
QSB107	11-5/8" x 8-3/8" x 4"	10-1/4" x 7-1/8" x 4"	20	15 lbs	DSB107	50	12	4
QSB109	11-5/8" x 11-1/8" x 4"	10-1/4" x 10" x 4"	8	7 lbs	DSB109	50	18	6
QSB103	17-7/8" x 4-1/8" x 4"	16-1/2" x 3" x 4"	20	13 lbs	DSB103	50	9	3
QSB104	17-7/8" x 6-5/8" x 4"	16-1/2" x 5-1/2" x 4"	20	16 lbs	DSB104	50	15	6
QSB108	17-7/8" x 8-3/8" x 4"	16-1/2" x 7-1/8" x 4"	10	11 lbs	DSB108	50	19	6
QSB110	17-7/8" x 11-1/8" x 4"	16-1/2" x 10" x 4"	8	11 lbs	DSB110	50	29	8
QSB105	23-5/8" x 4-1/8" x 4"	22-1/8" x 3" x 4"	16	13 lbs	DSB105	50	13	4
QSB106	23-5/8" x 6-5/8" x 4"	22-1/8" x 5-1/2" x 4"	8	9 lbs	DSB106	50	21	8
QSB114	23-5/8" x 8-3/8" x 4"	22-1/8" x 7-1/8" x 4"	6	9 lbs	DSB114	50	24	8
QSB116	23-5/8" x 11-1/8" x 4"	22-1/8" x 10" x 4"	6	10 lbs	DSB116	50	35	16

Individual labels are available for all Shelf Bins. For label Model No. substitute "L" for "Q" in bin Model No. Ctn Qty: 50 Individual Labels



AVAILABLE on pg. 84

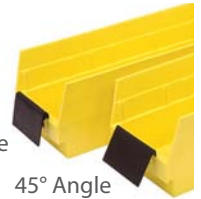

10° Angle

45° Angle

Extended Label Holders
simplify identification!



Optional extended label holders are designed for larger bar code scanning. Label holders fit all Shelf Bins (except QSB100).

MODEL NO.	DESCRIPTION	DIMENSIONS W" x H"	CTN QTY
ELH410	10° Angle	4" x 2-1/4"	24
ELH445	45° Angle	4" x 2-1/4"	24

13 SIZES AND 7 COLORS AVAILABLE!



QSB100



QSB101



QSB102



QSB103



QSB104



QSB105



QSB106



QSB107



QSB108



QSB109



QSB110



QSB114



QSB116

LOW COST!
LONG LASTING!
UNBREAKABLE!
REUSABLE!
4" high bins!



LTR-0813
Clear Label Holder
Clear label holders and laser label inserts. Package of 25. Label holders fit all bins (except QSB100).

Divider Label Tab



DLT-6

Divider Label Tabs attach to existing dividers to improve the visibility of bin labels and scanning of barcodes. Package of 6.



Dividers and Bin Cups



Optional dividers fit snugly, horizontally across bins and are uniquely designed to allow for easy part labeling via individual label slots. All bins can accommodate up to 7 dividers. Bin cups have a raised, slotted label holder for easy parts identification. The entire bin cup may be removed for easy part retrieval. Available in 2 sizes and 2 colors.

Available in: ● Blue ● Yellow

MODEL NO.	OUTSIDE DIMENSIONS L" x W" x H"	CTN QTY	CTN WGT
QBC111	3-1/4" x 1-3/4" x 3"	48	4 lbs
QBC112	5-1/8" x 2-3/4" x 3"	48	7 lbs



Economy Shelf Bin Wire Shelving Systems - Complete Packages



WR12-101
12"W x 36"L x 74"H
12 shelves and 77 QSB101
11-5/8"L x 4-1/8"W x 4"H bins



WR12-102
12"W x 36"L x 74"H
12 shelves and 55 QSB102
11-5/8"L x 6-5/8"W x 4"H bins



WR12-107
12"W x 36"L x 74"H
12 shelves and 44 QSB107
11-5/8"L x 8-3/8"W x 4"H bins



WR12-109
12"W x 36"L x 74"H
12 shelves and 33 QSB109
11-5/8"L x 11-1/8"W x 4"H bins

WR12-103
18"W x 36"L x 74"H
12 shelves and 77 QSB103
17-7/8"L x 4-1/8"W x 4"H bins

WR12-104
18"W x 36"L x 74"H
12 shelves and 55 QSB104
17-7/8"L x 6-5/8"W x 4"H bins

WR12-108
18"W x 36"L x 74"H
12 shelves and 44 QSB108
17-7/8"L x 8-3/8"W x 4"H bins

WR12-110
18"W x 36"L x 74"H
12 shelves and 33 QSB110
17-7/8"L x 11-1/8"W x 4"H bins

WR12-105
24"W x 36"L x 74"H
12 shelves and 77 QSB105
23-5/8"L x 4-1/8"W x 4"H bins

WR12-106
24"W x 36"L x 74"H
12 shelves and 55 QSB106
23-5/8"L x 6-5/8"W x 4"H bins

WR12-114
24"W x 36"L x 74"H
12 shelves and 44 QSB114
23-5/8"L x 8-3/8"W x 4"H bins

WR12-116
24"W x 36"L x 74"H
12 shelves and 33 QSB116
23-5/8"L x 11-1/8"W x 4"H bins

COMPLETE PACKAGES with bins!



MOBILIZE YOUR WIRE SHELVING

DB - Donut Bumper
Non-marking donut bumper used to protect walls and help cushion impact.

WR-00H (Mobile Kit)*
Set of four swivel polyurethane 5" x 1-1/4" casters, two with brakes. Can be used with all units shown. 1,200 lb. load capacity. *Mobile kits recommended only for shelves 18" and wider.

Complete Bin Center

Complete bin systems are available with 4 different size bins on a 12"W x 36"L x 36"H unit. This all-purpose bin center is an economical high density storage system that provides easy visibility to stored contents. Please specify.

- Easy boltless assembly
- Wire allows air to circulate as well as provides ideal product visibility
- Durable chrome finish ensures years of heavy-duty dependability and service

Available in: ● Blue ● Green ● Ivory ● Red ● Yellow ● Black ● Clear

MODEL NO.	NO. OF BINS	BIN SIZE L" x W" x H"	SHIP WGT
12" x 36" x 36" Unit, 6 Shelves			
WR6-36-1236-101	40 QSB101	11-5/8" x 4-1/8" x 4"	63 lbs
WR6-36-1236-102	25 QSB102	11-5/8" x 6-5/8" x 4"	50 lbs
WR6-36-1236-107	20 QSB107	11-5/8" x 8-3/8" x 4"	62 lbs
WR6-36-1236-109	15 QSB109	11-5/8" x 11-1/8" x 4"	64 lbs



WR6-36-1236-102

800 lb. capacity per shelf!



STORE-MORE 6" Shelf Bins



Maximize your storage space with durable, high density polypropylene bins. Quantum's exclusive STORE-MORE 6"H Shelf Bins are the industry standard for quality. These bins feature a molded-in label holder, built-in rear hang-lock which allows bins to tilt out for complete access when shelving. A wide hopper front allows complete access to the contents of the bin. Edges are reinforced for added strength. They are designed for 12", 18" and 24" deep shelf units, racks or standard shelving. Optional dividers are a perfect solution to create a par level system. Bins are waterproof and corrosion-free. Available in 4 colors. See pg. 85 to order Clear Bins.



Available in: ● Blue ● Red ● Yellow ● Clear

MODEL NO.	OUTSIDE DIMENSIONS L" x W" x H"	INSIDE DIMENSIONS L" x W" x H"	CTN QTY	CTN WGT	CTN DIVIDER	CTN QTY	NO. OF BIN CUPS PER BIN QBC111	QBC112
QSB201	11-5/8" x 4-1/8" x 6"	10-1/6" x 3" x 6"	36	19 lbs	DSB201	50	6	2
QSB202	11-5/8" x 6-5/8" x 6"	10-1/6" x 5-1/2" x 6"	30	20 lbs	DSB202	50	9	4
QSB207	11-5/8" x 8-3/8" x 6"	10-1/6" x 7-1/8" x 6"	20	17 lbs	DSB207	50	12	4
QSB209	11-5/8" x 11-1/8" x 6"	10-1/6" x 10" x 6"	8	9 lbs	DSB209	50	18	6
QSB203	17-7/8" x 4-1/8" x 6"	16-1/2" x 3" x 6"	20	15 lbs	DSB203	50	9	3
QSB204	17-7/8" x 6-5/8" x 6"	16-1/2" x 5-1/2" x 6"	20	18 lbs	DSB204	50	15	6
QSB208	17-7/8" x 8-3/8" x 6"	16-1/2" x 7-1/8" x 6"	10	13 lbs	DSB208	50	19	6
QSB210	17-7/8" x 11-1/8" x 6"	16-1/2" x 10" x 6"	8	13 lbs	DSB210	50	29	8
QSB205	23-5/8" x 4-1/8" x 6"	22-1/8" x 3" x 6"	16	15 lbs	DSB205	50	13	4
QSB206	23-5/8" x 6-5/8" x 6"	22-1/8" x 5-1/2" x 6"	8	11 lbs	DSB206	50	21	8
QSB214	23-5/8" x 8-3/8" x 6"	22-1/8" x 7-1/8" x 6"	6	11 lbs	DSB214	50	24	8
QSB216	23-5/8" x 11-1/8" x 6"	22-1/8" x 10" x 6"	6	12 lbs	DSB216	50	35	16

Individual labels are available for all STORE-MORE 6" Shelf Bins. For label Model No. substitute "L" for "Q" in bin Model No. Ctn Qty: 50 Individual Labels

12 SIZES AND 3 COLORS AVAILABLE!



QSB201



QSB202



QSB203



QSB204

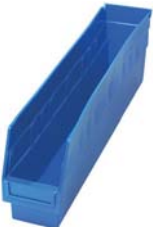

QSB205



QSB206



QSB207



QSB208



QSB209



QSB210



QSB214



QSB216

LOW COST! LONG LASTING!
UNBREAKABLE! REUSABLE!
6" high bins!



LTR-0813
Clear Label Holder
Clear label holders and laser label inserts. Clear label holders fit all 6" Shelf Bins. Package of 25.



AVAILABLE on pg. 85



10° Angle

45° Angle

Extended Label Holders
simplify identification!

Optional extended label holders are designed for larger bar code scanning. Label holders fit all 6" Shelf Bins.

MODEL NO.	DESCRIPTION	DIMENSIONS W" x H"	CTN QTY
ELH410	10° Angle	4" x 2-1/4"	24
ELH445	45° Angle	4" x 2-1/4"	24

Divider Label Tab

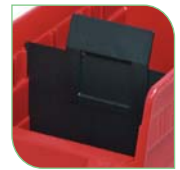

DLT-6

Divider Label Tabs attach to existing dividers to improve the visibility of bin labels and scanning of barcodes. Package of 6.



Dividers and Bin Cups

Optional black dividers fit snugly, horizontally across bins to create compartments. Each bin accepts up to 8 dividers. Bins have a slot at the very front allowing the open hopper to be closed off creating even more storage. Bin cups have a raised, slotted label holder for easy parts identification. The entire bin cup may be removed for easy part retrieval. Available in 2 sizes and 2 colors.

Available in: ● Blue ● Yellow

MODEL NO.	OUTSIDE DIMENSIONS L" x W" x H"	CTN QTY	CTN WGT
QBC111	3-1/4" x 1-3/4" x 3"	48	4 lbs
QBC112	5-1/8" x 2-3/4" x 3"	48	7 lbs



WR9-202

COMPLETE PACKAGES
with bins!



AVAILABLE on pg. 85

800 lb.
capacity per shelf!



MOBILIZE YOUR WIRE SHELVING

DB - Donut Bumper

Non-marking donut bumper used to protect walls and help cushion impact.

WR-00H (Mobile Kit)*

Set of four swivel polyurethane 5" x 1-1/4" casters, two with brakes. Can be used with all units shown. 1,200 lb. load capacity. *Mobile kits recommended only for shelves 18" and wider.

STORE-MORE 6" Shelf Bin Wire Shelving Systems - Complete Packages

- Easy boltless assembly
- Wire allows air to circulate as well as provides ideal product visibility
- Durable chrome finish ensures years of heavy-duty dependability and service
- All welded shelf construction is supported with architectural wire trusses to provide 800 lb. capacity per shelf
- Bins are available in Blue, Yellow, Red and Clear

MODEL NO.	NO. OF BINS	BIN SIZE L" x W" x H"	SHIP WGT
12" x 36" x 74" Unit, 9 Shelves			
WR9-201	64 QSB201	11-5/8" x 4-1/8" x 6"	108 lbs
WR9-202	40 QSB202	11-5/8" x 6-5/8" x 6"	100 lbs
WR9-207	32 QSB207	11-5/8" x 8-3/8" x 6"	98 lbs
WR9-209	24 QSB209	11-5/8" x 11-1/8" x 6"	96 lbs
18" x 36" x 74" Unit, 9 Shelves			
WR9-203	64 QSB203	17-7/8" x 4-1/8" x 6"	156 lbs
WR9-204	40 QSB204	17-7/8" x 6-5/8" x 6"	142 lbs
WR9-208	32 QSB208	17-7/8" x 8-3/8" x 6"	143 lbs
WR9-210	24 QSB210	17-7/8" x 11-1/8" x 6"	140 lbs
24" x 36" x 74" Unit, 9 Shelves			
WR9-205	64 QSB205	23-5/8" x 4-1/8" x 6"	182 lbs
WR9-206	40 QSB206	23-5/8" x 6-5/8" x 6"	171 lbs
WR9-214	32 QSB214	23-5/8" x 8-3/8" x 6"	165 lbs
WR9-216	24 QSB216	23-5/8" x 11-1/8" x 6"	154 lbs

STORE-MORE 6" Complete Bin Center

Complete bin systems are available with 4 different size bins on a 12"W x 36"L x 39"H unit. This all-purpose bin center is an economical high density storage system that provides easy visibility to stored contents.

MODEL NO.	NO. OF BINS	BIN SIZE L" x W" x H"	SHIP WGT
12" x 36" x 39" Unit, 5 Shelves			
WR5-39-1236-201	32 QSB201	11-5/8" x 4-1/8" x 6"	61 lbs
WR5-39-1236-202	20 QSB202	11-5/8" x 6-5/8" x 6"	57 lbs
WR5-39-1236-207	16 QSB207	11-5/8" x 8-3/8" x 6"	56 lbs
WR5-39-1236-209	12 QSB209	11-5/8" x 11-1/8" x 6"	55 lbs



WR9-207



WR9-209



WR5-39-1236-201



STORE-MAX 8" Shelf Bins



Quantum revolutionized the Shelf Bin market when we first introduced the 6" high Shelf Bins. Building on that success we are proud to showcase our new 8" high bins-offering 95% more storage capacity when compared to the standard 4" high bins and 65% more than the 6" high bins. The new STORE-MAX 8" Bins will truly maximize and organize your space. Manufactured from high density polypropylene, Quantum's exclusive STORE-MAX 8"H Shelf Bins are the industry standard for quality. These bins feature a molded-in label holder, built-in rear hang-lock which allows bins to tilt out for complete access when on shelving. A wide hopper front allows complete access to the contents of the bin. Edges are reinforced for added strength. They are designed for 12", 18" and 24" deep shelf units, racks or standard shelving. Optional dividers are a perfect accessory to subdivide and keep parts separated as needed. Available in 4 colors. See pg. 86 to order Clear Bins.

CLEAR BINS
VIEW
AVAILABLE on pg. 86



Available in: ● Blue ● Red ● Yellow ● Clear

MODEL NO.	OUTSIDE DIMENSIONS L" x W" x H"	INSIDE DIMENSIONS L" x W" x H"	CTN QTY	CTN WGT	DIVIDER	CTN QTY	NO. OF BIN CUPS PER BIN QBC111	QBC112
QSB801	11-5/8" x 4-3/8" x 8"	10-1/6" x 3" x 8"	36	27 lbs	DSB801	50	6	2
QSB802	11-5/8" x 6-5/8" x 8"	10-1/6" x 5-1/2" x 8"	30	26 lbs	DSB802	50	9	4
QSB807	11-5/8" x 8-3/8" x 8"	10-1/6" x 7-1/8" x 8"	20	21 lbs	DSB807	50	12	4
QSB809	11-5/8" x 11-1/8" x 8"	10-1/6" x 10" x 8"	8	11 lbs	DSB809	50	18	6
QSB803	17-7/8" x 4-3/8" x 8"	16-1/2" x 3" x 8"	20	22 lbs	DSB803	50	9	3
QSB804	17-7/8" x 6-5/8" x 8"	16-1/2" x 5-1/2" x 8"	20	26 lbs	DSB804	50	15	6
QSB808	17-7/8" x 8-3/8" x 8"	16-1/2" x 7-1/8" x 8"	10	15 lbs	DSB808	50	19	6
QSB810	17-7/8" x 11-1/8" x 8"	16-1/2" x 10" x 8"	8	17 lbs	DSB810	50	29	8
QSB805	23-5/8" x 4-3/8" x 8"	22-1/8" x 3" x 8"	16	24 lbs	DSB805	50	13	4
QSB806	23-5/8" x 6-5/8" x 8"	22-1/8" x 5-1/2" x 8"	8	13 lbs	DSB806	50	21	8
QSB814	23-5/8" x 8-3/8" x 8"	22-1/8" x 7-1/8" x 8"	6	12 lbs	DSB814	50	24	8
QSB816	23-5/8" x 11-1/8" x 8"	22-1/8" x 10" x 8"	6	14 lbs	DSB816	50	35	16

Individual labels are available for all STORE-MAX 8" Shelf Bins. For label Model No. substitute "L" for "Q" in bin Model No. Ctn Qty: 50 Individual Labels

new



Extended Label Holders
simplify identification!

Optional extended label holders are designed for larger bar code scanning. Label holders fit all 8" Shelf Bins.

MODEL NO.	DESCRIPTION	DIMENSIONS W" x H"	CTN QTY
ELH410	10° Angle	4" x 2-1/4"	24
ELH445	45° Angle	4" x 2-1/4"	24

12 SIZES AND 3 COLORS AVAILABLE!

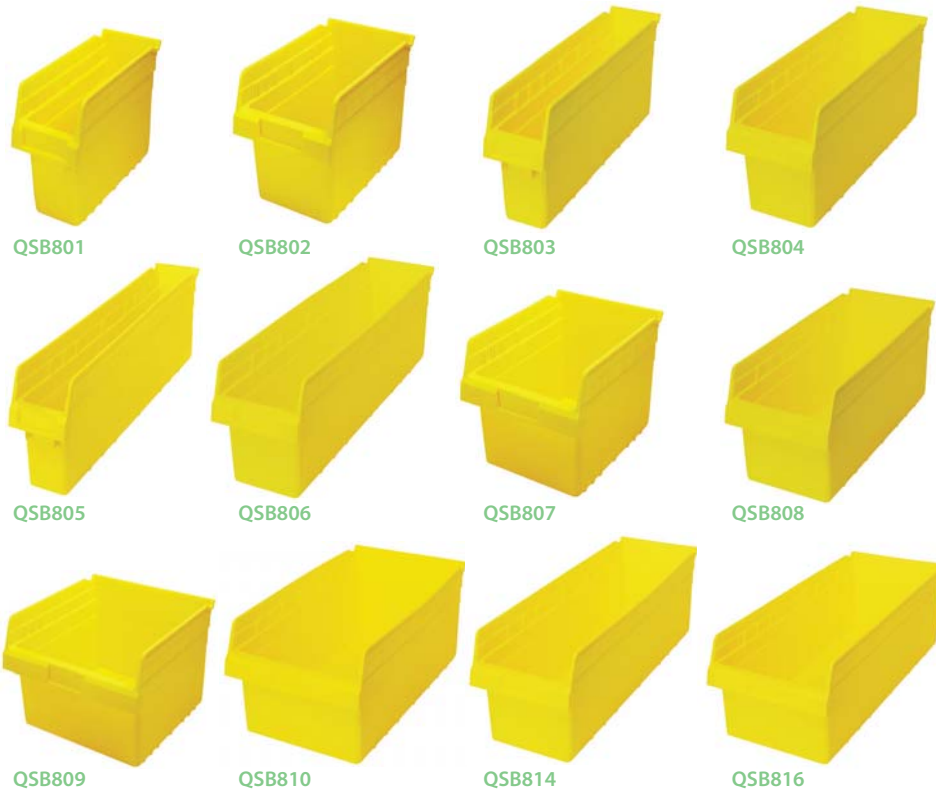

Divider Label Tab

Divider Label Tabs attach to existing dividers to improve the visibility of bin labels and scanning of barcodes. Package of 6.



DLT-6



Dividers and Bin Cups

Optional black dividers fit snugly, horizontally across bins to create compartments. Each bin accepts up to 7 dividers.

Bin cups have a raised, slotted label holder for easy parts identification. The entire bin cup may be removed for easy part retrieval. Available in 2 sizes and 2 colors.

Available in: ● Blue ● Yellow

MODEL NO.	OUTSIDE DIMENSIONS L" x W" x H"	CTN QTY	CTN WGT
QBC111	3-1/4" x 1-3/4" x 3"	48	4 lbs
QBC112	5-1/8" x 2-3/4" x 3"	48	7 lbs

LOW COST! LONG LASTING!
UNBREAKABLE! REUSABLE!
8" high bins!



LTR-0813
Clear Label Holder
Clear label holders and laser label inserts. Clear label holders fit all 8" Shelf Bins. Package of 25.



WR8-801

COMPLETE PACKAGES
with bins!



AVAILABLE on pg. 86

800 lb.
capacity per shelf!



MOBILIZE YOUR WIRE SHELVING

DB - Donut Bumper

Non-marking donut bumper used to protect walls and help cushion impact.

WR-00H (Mobile Kit)*

Set of four swivel polyurethane 5" x 1-1/4" casters, two with brakes. Can be used with all units shown. 1,200 lb. load capacity. *Mobile kits recommended only for shelves 18" and wider.

new

STORE-MAX 8" Shelf Bin Wire Shelving Systems - Complete Packages

- Easy boltless assembly
- Wire allows air to circulate as well as provides ideal product visibility
- Durable chrome finish ensures years of heavy-duty dependability and service
- All welded shelf construction is supported with architectural wire trusses to provide 800 lb. capacity per shelf
- Bins are available in Blue, Red, Yellow and Clear

MODEL NO.	NO. OF BINS	BIN SIZE L" x W" x H"	SHIP WGT
12" x 36" x 74" Unit, 8 Shelves			
WR8-801	49 QSB801	11-5/8" x 4-3/8" x 8"	100 lbs
WR8-802	35 QSB802	11-5/8" x 6-5/8" x 8"	103 lbs
WR8-807	28 QSB807	11-5/8" x 8-3/8" x 8"	102 lbs
WR8-809	21 QSB809	11-5/8" x 11-1/8" x 8"	101 lbs
18" x 36" x 74" Unit, 8 Shelves			
WR8-803	49 QSB803	17-7/8" x 4-3/8" x 8"	150 lbs
WR8-804	35 QSB804	17-7/8" x 6-5/8" x 8"	142 lbs
WR8-808	28 QSB808	17-7/8" x 8-3/8" x 8"	138 lbs
WR8-810	21 QSB810	17-7/8" x 11-1/8" x 8"	141 lbs
24" x 36" x 74" Unit, 8 Shelves			
WR8-805	49 QSB805	23-5/8" x 4-3/8" x 8"	194 lbs
WR8-806	35 QSB806	23-5/8" x 6-5/8" x 8"	177 lbs
WR8-814	28 QSB814	23-5/8" x 8-3/8" x 8"	176 lbs
WR8-816	21 QSB816	23-5/8" x 11-1/8" x 8"	169 lbs

STORE-MAX 8" Complete Bin Center

Complete bin systems are available with 4 different size bins on a 12"W x 36"L x 39"H unit. This all-purpose bin center is an economical high density storage system that provides easy visibility to stored contents.

MODEL NO.	NO. OF BINS	BIN SIZE L" x W" x H"	SHIP WGT
12" x 36" x 39" Unit, 4 Shelves			
WR4-39-1236-801	21 QSB801	11-5/8" x 4-3/8" x 8"	80 lbs
WR4-39-1236-802	15 QSB802	11-5/8" x 6-5/8" x 8"	78 lbs
WR4-39-1236-807	12 QSB807	11-5/8" x 8-3/8" x 8"	77 lbs
WR4-39-1236-809	9 QSB809	11-5/8" x 11-1/8" x 8"	77 lbs



WR8-802



WR8-809



WR4-39-1236-807

QuickPick Bin



These heavy-duty, polypropylene storage bins provide an open hopper front and back, allowing double access to stored parts. Bins stack one on top of the other, both vertically and cross-wise, and nest when empty for space efficiency. Optional dividers may be used front to back, side to side or both at the same time, dividing the bin into four sections. A molded in label holder on both the front and back of the bin allows for easy parts identification. Bins can be used on standard metal or wire shelving as well as on desks, bench tops or work stations. Available in 6 sizes and in 3 colors.

Available in: ● Blue ● Red ● Yellow

MODEL NO.	DIMENSIONS L" x W" x H"	CTN QTY	CTN WGT	CROSS DIVIDER	CTN QTY	LENGTH DIVIDER	CTN QTY
QP965	9-1/2" x 6-5/8" x 5"	20	15 lbs	CD965	10	LD965	10
QP1265	12-1/2" x 6-5/8" x 5"	20	19 lbs	CD1265	10	LD1265	10
QP1285	12-1/2" x 8-3/8" x 5"	20	22 lbs	CD1285	10	LD1285	10
QP1496	14" x 9-1/4" x 6-1/2"	20	26 lbs	CD1496	10	LD1496	10
QP1867	18-1/2" x 6-5/8" x 7"	10	16 lbs	CD1867	10	LD1867	10
QP1887	18-1/2" x 8-3/8" x 7"	10	18 lbs	CD1887	10	LD1887	10

6 SIZES AND 3 COLORS AVAILABLE!

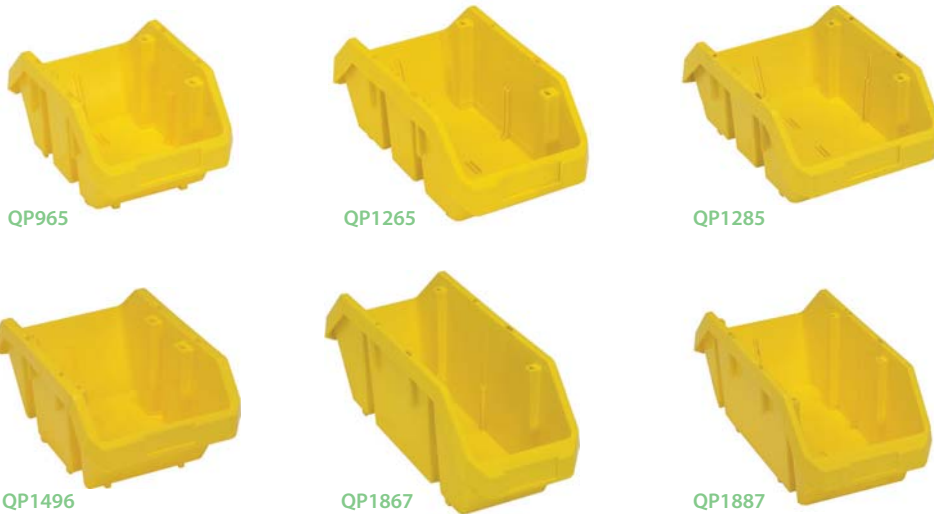

THE MOST VERSATILE BIN
IN THE HOSPITAL
with double sided access!



Double reinforced sides add strength and prevents bin from spreading when stacked

STACK 'EM



Bins nest when empty to save space

NEST 'EM

THE MOST UNIQUE STORAGE BINS AVAILABLE!

This double open hopper bin provides front and back access to stored parts!

CREATE UP TO 4
compartments!

Dividers

Optional dividers may be used front to back, side to side or both at the same time, dividing the bin into four sections.



QP1265
Shown with optional
Dividers CD1265 / LD1265
(Sold separately)



Built-in stacking ledges allow secure stacking and cross stacking

CROSS STACK 'EM



W7-12-26

800 lb.
capacity per shelf!



MOBILIZE YOUR WIRE SHELVING

DB - Donut Bumper

Non-marking donut bumper used to protect walls and help cushion impact.

WR-00H (Mobile Kit)*

Set of four swivel polyurethane 5" x 1-1/4" casters, two with brakes. Can be used with all units shown. 1,200 lb. load capacity. *Mobile kits recommended only for shelves 18" and wider.

COMPLETE PACKAGES
with bins!



WRC3-1836-1867

Heavy-Duty Wire Shelving with QuickPick Bins Complete Packages

These unique shelving packages provide "double" access to stored parts. QuickPick Bins allow two users to access stored product at the same time! This ergonomic, space efficient work station is the ultimate space saver! Shelving units measure 18"W x 36"L x 74"H and may be ordered with or without a mobile kit. These heavy-duty units offer an 800 lb. capacity per shelf. Optional dividers may be used front to back, side to side or both at the same time, dividing the bin into four sections. See chart above for ordering instructions. A molded in label holder on both the front and back of the bin allows for easy part identification. Bins are available in 3 colors.

Available in: ● Blue ● Red ● Yellow

MODEL NO.	NO. OF BINS	DIMENSIONS L" x W" x H"	SHIP WGT
W7-12-30	30	12-1/2" x 6-5/8" x 5"	110 lbs
W7-12-26	10	12-1/2" x 6-5/8" x 5"	107 lbs
	16	12-1/2" x 8-3/8" x 5"	
W7-12-28	20	12-1/2" x 6-5/8" x 5"	109 lbs
	8	12-1/2" x 8-3/8" x 5"	
W7-12-24	24	12-1/2" x 8-3/8" x 5"	106 lbs
W7-14-18	18	14" x 9-1/4" x 6-1/2"	105 lbs
W7-18-30	30	18-1/2" x 6-5/8" x 7"	128 lbs
W7-18-26	10	18-1/2" x 6-5/8" x 7"	125 lbs
	16	18-1/2" x 8-3/8" x 7"	
W7-18-28	20	18-1/2" x 6-5/8" x 7"	127 lbs
	8	18-1/2" x 8-3/8" x 7"	
W7-18-24	24	18-1/2" x 8-3/8" x 7"	124 lbs
Mobile Kit			
WR-00H	Mobilizes Wire Shelving Unit		14 lbs

DOUBLE SIDED
access!

QuickPick Bin Mobile Wire Cart

These heavy-duty, polypropylene storage bins provide an open hopper front and back, allowing double access to stored parts. Unit comes in a 2 or 3 shelf configuration complete with four casters (all swivel and two with brakes). Overall dimensions: 18"W x 36"L x 37-1/2"H. Mobile cart is easy to assemble. Bins are available in 3 colors. One color per unit. Length and/or Cross Dividers available on pg. 114.

Available in: ● Blue ● Red ● Yellow

MODEL NO.	NO. OF BINS	BIN DIMENSIONS L" x W" x H"	SHIP WGT
WRC2-1836-1265	10	12-1/2" x 6-5/8" x 5"	49 lbs
WRC3-1836-1265	15	12-1/2" x 6-5/8" x 5"	64 lbs
WRC2-1836-1285	8	12-1/2" x 8-3/8" x 5"	48 lbs
WRC3-1836-1285	12	12-1/2" x 8-3/8" x 5"	63 lbs
WRC2-1836-1867	10	18-1/2" x 6-5/8" x 7"	55 lbs
WRC3-1836-1867	15	18-1/2" x 6-5/8" x 7"	73 lbs
WRC2-1836-1887	8	18-1/2" x 8-3/8" x 7"	54 lbs
WRC3-1836-1887	12	18-1/2" x 8-3/8" x 7"	72 lbs

Super Tuff Euro Drawers



Super Tuff Euro Drawers are available in nine sizes and four colors and are designed for efficient organization of heavy parts, supplies, tools or equipment. Super Tuff Euro Drawers are injection molded from a virgin grade high impact polystyrene and are virtually unbreakable. With a full 12 gauge wall thickness, these heavy-duty drawers can be used on Quantum's open and closed shelf units and pick racks. Available in 4 colors.

Available in: ● Blue ● Red ● Yellow ● Gray

MODEL NO.	OUTSIDE DIMENSIONS L" x W" x H"	CTN QTY	CTN WGT	DIVIDER	CTN QTY	NUMBER OF DIVIDER SLOTS
QED401	11-5/8" x 5-9/16" x 2-5/8"	24	17 lbs	DIV401	4	8
QED501	11-5/8" x 3-3/4" x 4-5/8"	24	19 lbs	DIV501/604	4	8
QED601	11-5/8" x 5-9/16" x 4-5/8"	24	24 lbs	DIV6123	4	8
QED701	11-5/8" x 8-3/8" x 4-5/8"	24	31 lbs	DIV701/606	4	8
QED801	11-5/8" x 11-1/8" x 4-5/8"	12	19 lbs	DIV801	4	8
QED604	17-5/8" x 3-3/4" x 4-5/8"	24	29 lbs	DIV501/604	4	15
QED602	17-5/8" x 5-9/16" x 4-5/8"	24	32 lbs	DIV6123	4	13
QED606	17-5/8" x 8-3/8" x 4-5/8"	24	46 lbs	DIV701/606	4	13
QED603	23-7/8" x 5-9/16" x 4-5/8"	12	25 lbs	DIV6123	4	18

PERFORMANCE FEATURES AT A GLANCE:

- Available in 9 sizes
- Bins are injection molded from a virgin grade high impact polystyrene and are virtually unbreakable
- Drawers are completely waterproof
- Drawers are oil and chemical resistant
- Smooth front curved pull handle has ample room for pressure sensitive identification labels or bar code
- Front handle has 3/4" opening for convenient easy gripping
- Full width back ledge ensures spill free use
- Optional dividers are full height for extra holding power and prevents mixing of parts
- Available in four colors ideal for color coding inventory: Blue, Yellow, Red and Gray

HEAVY-DUTY DRAWERS
virtually unbreakable



12" Deep Euro Drawers

9 SIZES AVAILABLE!

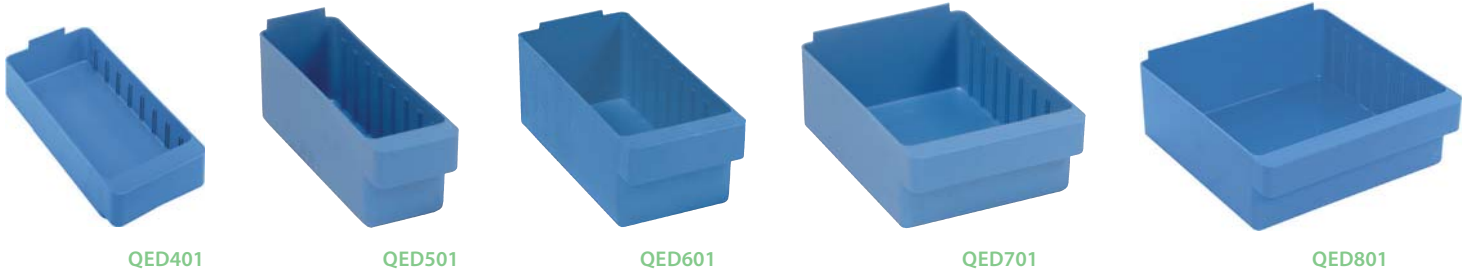

18" Deep Euro Drawers

24" Deep Euro Drawers





Dividers

Containers can be divided by length and/or width allowing a subdivision down to a 1-1/8" square compartment size. Available in Gray.



Snap On Covers

Snap on covers protect contents from damage or dust during shipping and storage.



Clear Label Holder

Fits any size container. Three sizes to choose from.



Dividable Grid Containers



Heavy-duty Dividable Grid Containers can be used in health-care for storage, kitting and distribution applications. These containers offer the safest and most efficient method for compartmentalizing and protecting small to medium sized items. Dividers allow you to customize the container's interior to meet your exact needs. Containers and covers are available in 4 colors. See pg. 82 to order Clear Containers.

Available in: ● Blue ● Red ● Gray ● Clear

MODEL NO.	OUTSIDE DIMENSIONS L" x W" x H"	INSIDE DIMENSIONS L" x W" x H"	CTN QTY	CTN WGT	LONG DIVIDER	CTN QTY	SHORT DIVIDER	CTN QTY	COVER	CTN QTY
DG91035	10-7/8" x 8-1/4" x 3-1/2"	9-3/16" x 6-9/16" x 3"	20	24 lbs	DL91035	6	DS91035	6	COV91000	10
DG91050	10-7/8" x 8-1/4" x 5"	9-3/16" x 6-9/16" x 4-1/2"	20	32 lbs	DL91050	6	DS91050	6	COV91000	10
DG92035	16-1/2" x 10-7/8" x 3-1/2"	14-7/8" x 9-1/4" x 3"	12	23 lbs	DL92035	6	DS92035	6	COV92000	4
DG92060	16-1/2" x 10-7/8" x 6"	14-7/8" x 9-1/4" x 5-1/2"	8	20 lbs	DL92060	6	DS92060	6	COV92000	4
DG92080	16-1/2" x 10-7/8" x 8"	14-7/8" x 9-1/4" x 7-1/2"	8	27 lbs	DL92080	6	DS92080	6	COV92000	4
DG93030	22-1/2" x 17-1/2" x 3"	20-5/8" x 15-5/8" x 2-1/2"	6	20 lbs	DL93030	6	DS93030	6	COV93000	3
DG93060	22-1/2" x 17-1/2" x 6"	20-5/8" x 15-5/8" x 5-1/2"	3	16 lbs	DL93060	6	DS93060	6	COV93000	3
DG93080	22-1/2" x 17-1/2" x 8"	20-5/8" x 15-5/8" x 7-1/2"	3	19 lbs	DL93080	6	DS93080	6	COV93000	3
DG93120	22-1/2" x 17-1/2" x 12"	20-5/8" x 15-5/8" x 11-1/2"	3	23 lbs	DL93120	6	DS93120	6	COV93000	3



AVAILABLE on pg. 82

9 SIZES AND 4 COLORS AVAILABLE!



DG91035



DG91050



DG92035



DG92060



DG92080



DG93030



DG93060



DG93080



DG93120

Clear Label Holders

MODEL NO.	DIMENSIONS H" x W"	FITS BIN MODEL NO.	CTN QTY
LBL2X8	2" x 8"	DG91035, DG92035, DG93030	6
LBL3X5	3" x 5"	DG91050, DG92060, DG93060	6
LBL5X8	5" x 8"	DG92080, DG93080, DG93120	6



Clear Dust Cover Acrylic Inlays

Clear Acrylic Dust Cover Inlays keep stored items visible while protecting against airborne dust and other contaminants. Cover lays inside on rim of container.

MODEL NO.	FITS BIN MODEL NO.	CTN QTY
DDC91000CL	DG91035, DG91050	10
DDC92000CL	DG92035, DG92060, DG92080	4
DDC93000CL	DG93030, DG93060, DG93080, DG93120	3



Clear Covers

MODEL NO.	FITS BIN MODEL NO.	CTN QTY
COV91000CL	DG91035, DG91050	10
COV92000CL	DG92035, DG92060, DG92080	4
COV93000CL	DG93030, DG93060, DG93080, DG93120	3



Genuine stack and nest totes



These heavy-duty, tough, and dependable stack and nest totes are the ultimate reusable container for storing and transporting your medical supplies. These proven containers are available in nine sizes and three colors for efficiency and inventory control. Ideal for use in Central Supply and distribution centers. Available in 3 colors.



Available in: ● Blue ● Red ● Gray

MODEL NO.	OUTSIDE DIMENSIONS L" x W" x H"	A	B	INSIDE DIMENSIONS			CAPACITY (CU FT)	CTN QTY	CTN WGT	LID	CTN QTY
				C	D	E					
snt180	18" x 11" x 6"	10"	16"	15-1/4"	9-3/8"	5-7/8"	0.50	6	12 lbs	LID181	6
snt185	18" x 11" x 9"	10"	16"	15-1/8"	9-1/8"	8-7/8"	0.76	6	15 lbs	LID181	6
snt190	19-1/2" x 15-1/2" x 10"	14-1/2"	17"	16"	13-1/4"	9-7/8"	1.20	6	23 lbs	LID191	6
snt195	19-1/2" x 15-1/2" x 13"	14-1/2"	17"	15-7/8"	13-3/8"	12-7/8"	1.70	6	26 lbs	LID191	6
snt200	19-1/2" x 13-1/2" x 8"	12-3/8"	17-7/8"	16-3/8"	11-1/2"	7-7/8"	0.80	6	19 lbs	LID201	6
snt225	23-1/2" x 19-1/2" x 10"	18-1/4"	20-7/8"	19-3/8"	16-7/8"	9-7/8"	2.00	3	18 lbs	LID231	3
snt230	23-1/2" x 19-1/2" x 13"	18-1/8"	20-7/8"	19-1/2"	16-7/8"	12-7/8"	2.60	3	22 lbs	LID231	3
snt240	23-1/2" x 15-1/2" x 12"	14-1/4"	20-7/8"	19-5/8"	13"	11-7/8"	1.70	3	18 lbs	LID241	3
snt300	29-1/2" x 19-1/2" x 15"	18-1/4"	26-5/8"	25-1/8"	16-5/8"	14-7/8"	3.70	3	31 lbs	LID301	3
snh010	Clear Label Holder - 3" x 5" (Fits all tote sizes)							6	1 lb	-	-



snh010

All nine sizes of totes have ability to use the optional clear label holder. It securely attaches to tote with or without lid for easy part identification.



Optional lid snaps on tightly and securely to protect container contents. As pictured, lids can be fastened and locked for added security.

9 SIZES AND 3 COLORS AVAILABLE!



Bin Inside Dimensions Guide
A, B, C, D, E

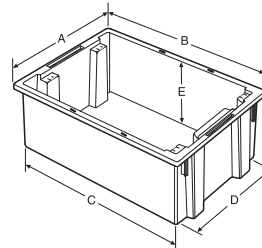

Polymer Dunnage Rack



MODEL NO.	DIMENSIONS W" x L" x H"	SHIP WGT
Ventilated		
362412DPP	24" x 36" x 12"	13 lbs
363612DPP	36" x 36" x 12"	22 lbs
482412DPP	24" x 48" x 12"	19 lbs
662412DPP	24" x 66" x 12"	23 lbs
663612DPP	36" x 66" x 12"	37 lbs
962412DPP	24" x 96" x 12"	34 lbs
963612DPP	36" x 96" x 12"	53 lbs
Solid		
362412DPS	24" x 36" x 12"	17 lbs
363612DPS	36" x 36" x 12"	26 lbs
482412DPS	24" x 48" x 12"	21 lbs
662412DPS	24" x 66" x 12"	28 lbs
663612DPS	36" x 66" x 12"	49 lbs
962412DPS	24" x 96" x 12"	41 lbs
963612DPS	36" x 96" x 12"	64 lbs

PERFORMANCE FEATURES AT A GLANCE:

- Available in 9 sizes
- Standard colors: Blue, Red and Gray
- Totes are injection molded from high-density polypropylene material that complies with the USDA and FDA regulations
- stack and nest totes will not corrode, bend out of shape, are unaffected by chemicals and are waterproof
- Reusable container will stack with or without lids for maximum storage and shipping
- snt's have the unique ability to stack or they can be turned 180° to nest when empty saving valuable space
- Optional lids for totes can be secured with nylon ties
- Textured bottoms ensure safe and easy, non-slip grip in transit on conveyors



WR9-36180
Shown with optional lid and label holders (Sold separately)



MOBILIZE YOUR WIRE SHELVING

DB - Donut Bumper
Non-marking donut bumper used to protect walls and help cushion impact.

WR-00H (Mobile Kit)*
Set of four swivel polyurethane 5" x 1-1/4" casters, two with brakes. Can be used with all units shown. 1,200 lb. load capacity. *Mobile kits recommended only for shelves 18" and wider.



WR7-92080
Optional dividers allow for multiple compartment configurations within each bin



MWR4-2419-9
These heavy-duty tubs provide easy access to stored parts for assembly areas

Chrome Wire Shelving System with Genuine stack and nest totes

Offering a whopping 800 lb. capacity per shelf, this chrome wire shelving unit with totes is a must have for archival storage, heavy-duty parts organization or inventory control applications. With three packages to choose from offering three colors choices for the bins, this unit can be used just about anywhere! Unit may be made mobile with the addition of the **WR-00H** mobile kit. See pg. 118 for additional information and to order optional accessories.

MODEL NO.	NO. OF SHELVES	NO. OF BINS	BIN DIMENSIONS L" x W" x H"	SHIP WGT
18" x 48" x 74" Wire Shelving Unit With stack and nest totes Available in Gray, Blue and Red				
WR9-36180	9	36 snt180	18" x 11" x 6"	178 lbs
WR6-24185	6	24 snt185	18" x 11" x 9"	136 lbs
24" x 66" x 63" Wire Shelving Unit With stack and nest totes Available in Gray, Blue and Red				
WR4-12225	4	12 snt225	23-1/2" x 19-1/2" x 10"	170 lbs

Chrome Wire Shelving System with Dividable Grid Containers

Same durable chrome wire shelving combined with Quantum's Dividable Grid Containers. These containers allow for multiple compartment configurations within each bin. Offering four different packages, these systems are ideal for small, medium and large parts storage. Unit may be made mobile with the addition of the **WR-00H** mobile kit. See pg. 117 for additional information and to order optional accessories.

MODEL NO.	NO. OF SHELVES	NO. OF BINS	BIN DIMENSIONS L" x W" x H"	SHIP WGT
18" x 48" x 74" Wire Shelving Unit With Dividable Grid Containers Available in Gray, Blue, Red and Clear				
WR9-92060	9	36 DG92060	16-1/2" x 10-7/8" x 6"	210 lbs
WR7-92080	7	24 DG92080	16-1/2" x 10-7/8" x 8"	174 lbs
24" x 60" x 63" Wire Shelving Unit With Dividable Grid Containers Available in Gray, Blue, Red and Clear				
WR12-93030	12	36 DG93030	22-1/2" x 17-1/2" x 3"	274 lbs
24" x 60" x 74" Wire Shelving Unit With Dividable Grid Containers Available in Gray, Blue, Red and Clear				
WR9-93060	9	24 DG93060	22-1/2" x 17-1/2" x 6"	254 lbs

Chrome Mobile Wire Shelving Systems with Cross Stack Tubs & Quantub Nesting Tote

These unique packages provide a storage solution for large, bulky items. These heavy-duty tubs provide easy access to stored parts for assembly areas, picking stations or inventory control. With three packages to choose from, these strong durable totes provide a durable solution for most applications. See pg. 120 for more information.

MODEL NO.	NO. OF SHELVES	NO. OF BINS	BIN DIMENSIONS L" x W" x H"	SHIP WGT
24" x 60" x 69" Mobile, Wire Shelving Unit With QuanTub Totes Available in Gray and Blue				
MWR4-2419-9	4	12 TUB2419-9	24-1/2" x 19" x 9-1/2"	175 lbs
18" x 36" x 69" Mobile, Wire Shelving Unit With Cross Stack Tubs Available in Gray, Blue and White				
MWR7-1711-8	7	24 TUB1711-8	17-1/4" x 11" x 8"	151 lbs
MWR5-1711-12	5	15 TUB1711-12	17-1/4" x 11" x 12"	118 lbs

Cross Stack Tubs



Manufactured of approved USDA/FDA materials, tote nests when empty or can be turned 90° to cross stack. Easy access to items when stacked. Injection molded from durable, high impact polypropylene. Easy to clean. Built in handles and bottom grooves makes handling easy. Holds up to 100 lbs. Six 1/4" drill hole pattern on bottom of bin allow for easy hole insertion for optional air flow and drainage. Available in 3 colors. 6 per carton.

Available in: ●Blue ●Gray ○White

MODEL NO.	OUTSIDE DIMENSIONS L" x W" x H"	CAP GAL	CTN QTY	CTN WGT	LID	CTN QTY
TUB1711-8	17-1/4" x 11" x 8"	3.85	6	14 lbs	LID1711	6
TUB1711-12	17-1/4" x 11" x 12"	5.51	6	17 lbs	LID1711	6
TUB2417-8	23-3/4" x 17-1/4" x 8"	9.81	6	25 lbs	LID2417	6
TUB2417-12	23-3/4" x 17-1/4" x 12"	14.38	6	30 lbs	LID2417	6
TUB2516-8	25-1/8" x 16" x 8-1/2"	9.75	6	20 lbs	LID2516-8	6
SNH010	Six Clear Label Holders - 3" x 5"		6	1 lb		



TUB2516-8

5 SIZES AND 3 COLORS AVAILABLE!



TUB1711-8



TUB1711-12



TUB2417-8

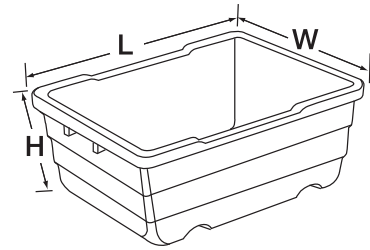

Bin Dimensions Guide
L (length) W (width) H (height)



TUB2417-12



TUB2516-8



LID2516-8

Optional lid keeps stored items dust free. Tubs can still stack and cross stack with lids in place!



snh010

3" x 5" Clear Label Holder securely attaches to totes and allows for easy part identification. Fits all tub sizes.

QuanTub Nesting Tote



Manufactured of approved USDA/FDA materials, this tote is ideal in food service or dietary department applications. Strong and durable tote is injection molded from high-density polypropylene. Each tote can hold up to 100 lbs. Lightweight and economical tote is easy to clean. Rolled top rim for comfortable grip. Rounded corners add strength to stress points. Totes nest when empty and prevent jamming with rib top. Six 1/4" drill hole pattern on bottom of bin allow for easy hole insertion for optional air flow and drainage. Measures 24-1/2"L x 19"W x 9-1/2"H. Available in 2 colors. 6 per carton.

Available in: ●Blue ●Gray

MODEL NO.	OUTSIDE DIMENSIONS L" x W" x H"	CTN QTY	CTN WGT
TUB2419-9	24-1/2" x 19" x 9-1/2"	6	33 lbs



TUB2419-9



ATTACHED PULL RING allows dolly to be pulled with ease



Polymer Mobile Dolly

DLY-3018 Dolly with Padded Rubber Trim available in Blue. 1,000 lbs. capacity. Interior Dimensions 24"L x 16-3/4"W Exterior Dimensions 30"L x 18"W

MODEL NO.	DESCRIPTION	CTN WGT
DLY-3018	Dolly with Padded Rubber Trim	19 lbs
HANDLE-DLY	32" Dolly Pull Rod with Handle	2 lbs

Bins sold separately.

Tub Racks - Completed Packages

All-welded aluminum Tub Rack transports and stores all types of product. Carts come complete and are shipped assembled with bins. Runners allow bins to slide in and out from both sides. Bins available in 3 colors.

Available in: ●Blue ●Gray ○White

MODEL NO.	DIMENSIONS L" x W" x H"	NO. OF BINS	SHIP WGT
Tub Rack with Cross Stack Tubs			
Tub Dimensions 25-1/8"L x 16"W x 8-1/2"H			
TR1-2516-8	27" x 19" x 19"	1	13 lbs
TR2-2516-8	27" x 19" x 31"	2	25 lbs
TR3-2516-8	27" x 19" x 41"	3	33 lbs
TR4-2516-8	27" x 19" x 51"	4	46 lbs
TR5-2516-8	27" x 19" x 61"	5	54 lbs
TR6-2516-8	27" x 19" x 71"	6	58 lbs

COMPLETE PACKAGES
with bins!



TR1-2516-8
Includes 1 TUB2516-8



TR2-2516-8
Includes 2 TUB2516-8



TR3-2516-8
Includes 3 TUB2516-8



TR4-2516-8
Includes 4 TUB2516-8



TR5-2516-8
Includes 5 TUB2516-8



TR6-2516-8
Includes 6 TUB2516-8

Heavy-Duty Attached Top Containers
Perfect for distribution and off-premises supply centers!



Strong, reliable and reusable totes are ideal for storage, distribution and order picking. Tops are permanently attached with steel hinges that interlock for stacking strength and security. Stack for maximized storage and nest when empty. Textured, non-slip bottom ensures smooth conveying. Ergonomically designed handles allow for easy lifting. Recessed lids ensure maximum load stability. Padlock eye provides security option allowing lids to be fastened and/or locked. Molded from high density, FDA approved polyethylene. Lids close securely to protect parts from dust or damage. Available in Gray.



STRONG! RELIABLE!
 reusable totes!



CUSTOM COLORS
 AVAILABLE!
 call for details.

MODEL NO.	OUTSIDE DIMENSIONS		INSIDE DIMENSIONS		CONTAINER HEIGHT	VOLUME (CU FT)	CAPACITY GAL	STACK CAP/ QTY STACKED	CTN WGT
	TOP L" x W"	BOTTOM L" x W"	TOP L" x W"	BOTTOM L" x W"					
QDC2012-7	19-5/8" x 11-9/16"	17" x 9-1/4"	17-9/16" x 9-13/16"	16-1/4" x 8-5/8"	7-1/2"	0.50	8.75	45 lbs / 7	4 lbs
QDC2115-9	21-3/4" x 14-7/8"	18-15/16" x 13-1/8"	19-5/8" x 14"	18-3/8" x 12-9/16"	9-5/8"	1.27	9.50	65 lbs / 5	6 lbs
QDC2115-12	21-3/4" x 15"	18-9/16" x 12-5/8"	19-3/4" x 14"	18" x 12-1/4"	12-3/4"	1.67	12.50	75 lbs / 5	7 lbs
QDC2115-17	21-7/8" x 15-1/8"	18-3/8" x 12-7/8"	20" x 14-1/2"	17-7/8" x 12-1/2"	17-1/4"	2.31	17.25	100 lbs / 3	8 lbs
QDC2213-12	22-1/8" x 12-5/8"	18-7/8" x 10-7/8"	19-7/8" x 12"	18-1/2" x 10-1/8"	11-7/8"	1.42	12.25	75 lbs / 5	6 lbs
QDC2420-12	23-7/8" x 19-3/8"	21-1/4" x 17-5/16"	22-1/4" x 18"	20-5/8" x 16-5/8"	12-1/2"	2.44	18.25	85 lbs / 5	8 lbs
QDC2717-12	27-5/16" x 16-9/16"	24-1/4" x 14-1/2"	25-1/8" x 15-3/8"	23-3/8" x 13-3/4"	12-1/2"	2.50	18.75	100 lbs / 4	8 lbs
QDC2515-14	25-1/8" x 15-1/4"	22-1/8" x 13"	23-3/8" x 14-5/8"	21-1/2" x 12-5/8"	13-3/4"	2.20	16.50	100 lbs / 4	8 lbs
QDC2820-15	28-1/8" x 20-5/8"	25-3/4" x 18-3/4"	25-7/8" x 19-3/4"	25-1/8" x 18"	15-5/8"	4.00	29.92	100 lbs / 4	13 lbs

Available in: ● Gray ● Custom

9 SIZES AVAILABLE!



QDC2012-7



QDC2115-17



QDC2115-12



QDC2115-17



QDC2213-12



QDC2420-12



QDC2515-14



QDC22717-12



QDC2820-15

HOT STAMPING
 AVAILABLE!
 call for details.



Polymer Mobile Dolly

DLY-2415 Dolly with 1" Ledge, available in Black. 1,000 lbs. capacity. Interior Dimensions 24"L x 15"W Exterior Dimensions 28"L x 18-1/2"W

MODEL NO.	DESCRIPTION	CTN WGT
DLY-2415	Dolly with 1" Ledge	14 lbs

Bins sold separately.



QDL-2115
 Distribution container has an optional 3" x 5" adhesive clear label holder which attaches securely for easy part identification. 24 per carton.

CREATE YOUR OWN first aid kit!



TC-500



Industrial-strength polypropylene

Perfect for all your first aid supplies.

Deep compartments make transporting supplies easy

First Aid Caddy



Heavy-duty, hand-held caddy ideal for all your first aid supplies. This portable, hand-held caddy provides a comfortable grip handle even when carrying heavy loads. Deep compartments make transporting supplies easy. Easy to clean. Available in Blue and Gray. 6 per carton.



Comfortable grip handle even when carrying heavy load

MODEL NO.	OUTSIDE DIMENSIONS L" x W" x H"	CTN QTY	CTN WGT
TC-500	13-7/8" x 18-3/8" x 9"	6	13 lbs

Clear Compartment Storage Box



Clear compartment storage box offers 10 individualized compartments for small to medium parts storage. Perfect for bandages, gels, gauze, and medication. Manufactured of clear, see-through polypropylene.



QB900

MODEL NO.	OUTSIDE DIMENSIONS L" x W" x H"	CTN QTY	CTN WGT
QB900	10-1/4" x 13" x 2-3/8"	6	8 lbs

10 COMPARTMENTS
for small & medium parts

Portable Computer / LAN Work Center

New portable computer center and mini LAN (local area network) work center offers flexibility in any operation. The modular characteristics allow the unit to be adaptable to all your equipment requirements such as servers, PCs, printers, keyboards, and monitors. This system features adjustable shelves on 1" increments, quick field assembly without the use of tools, excellent strength (up to 800 lbs. per shelf), durable chrome finish and easy to roll locking 3" polyurethane casters.

- Unit consists of:
- 4 - 34" posts
 - 3 - 24" x 30" wire shelves
 - 1 - keyboard shelf
 - 1 - document holder basket
 - 4 - 3" poly stem casters



M2430CLAN
(computer, monitor, keyboard, printer, binder not included)

Clear Tip Out Bins



Space saving bin units keep small and medium sized parts organized, sorted and easy to find. These clear, break resistant injection molded plastic containers tip open smoothly to a 45° angle and are completely removable for easy access and refilling. Molded handle with slots for labels is provided. Bins are easily cleaned with soap and water. Polystyrene cabinet can be stacked or wall mounted. Exterior available in 3 colors. Cups are clear. Optional dividers, locking rod and louvered panel bracket also available.

Available in: ● Ivory ● Gray ○ White

MODEL NO.	OUTSIDE DIMENSIONS L" x W" x H"	BIN DIMENSIONS L" x W" x H"	CTN QTY	CTN WGT
QTB301	11-3/4" x 11-13/16" x 13-7/8"	8-7/8" x 11-1/16" x 13-5/8"	1	7 lbs
QTB302	11-3/4" x 23-5/8" x 13-7/8"	8-7/8" x 11-1/16" x 13-5/8"	1	14 lbs
QTB303	7-3/4" x 23-5/8" x 9-1/2"	5-7/8" x 7-3/8" x 8-5/8"	1	9 lbs
QTB304	6-5/8" x 23-5/8" x 8-1/8"	5" x 5-5/8" x 7-1/2"	1	7 lbs
QTB305	5-1/4" x 23-5/8" x 6-1/2"	3-3/4" x 4-1/4" x 5-3/4"	1	5 lbs
QTB306	3-5/8" x 23-5/8" x 4-1/2"	2-5/8" x 3-1/2" x 3-3/4"	1	2 lbs
QTB309	2-1/2" x 23-5/8" x 3-1/8"	1-3/4" x 2-3/16" x 2-1/2"	1	2 lbs
DIV303	3 Dividers for QTB303		3	2 lbs
DIV304	4 Dividers for QTB304		4	1 lb
QLR500	Locking Rod for 23-5/8"W Tip Out Bins		1	1 lb
QTB-LP-BKT	Louvered Panel Bracket pair for Tip Out Bins		1	1 lb



QTB309



QTB306



QTB305



QTB304



QTB303



QTB302



QTB301

TIP OUT BIN CLEAR COMPARTMENTS KEEP small items sorted and easy to find!



TBC-32WT
Tip Out Bin Cart

19-1/2"L x 25"W x 41"H

Comes complete with two 5-bin, four 4-bin units and two 3-bin units for 32 total compartments. Tray can be pulled out from either side for additional work space. Comes fully assembled, ready to use. Ideal for use from anesthesia to pharmacy applications. Available in White.



QTB-LP-BKT

Louvered Panel Bracket

Hang 23-5/8"W bin on louvered panel using bracket. Available in Beige or Gray. Panels available on pg. 94.



QLR500

Locking Rod

Keeps bins from tilting open. Can be used with 23-5/8"W bins.



DIV303 and DIV304

QTB303 and QTB304 cup can use optional divider, as shown above.

TIP OUT BIN



CLEAR TIP OUT BIN SYSTEMS can be used in any application



Industrial, Mechanical and Plumbing Supplies
Very handy for the garage, tool shed, service vehicle, factory, hardware and home center facilities.



Medical
Very efficient when it comes to organizing and keeping an effective inventory in hospitals, pharmacies, labs or clinics.



Playroom
The smartest organizer after a hard day's play. It will help keep your child's room in order.



QT B410
QT B410 is a one bin design, 12" wide Each QT B410 comes with 3 DIV400 clear dividers*

TIP OUT BIN



QT B411
QT B411 is a two bin design, each bin 12" wide Each QT B411 comes with 6 DIV400 clear dividers*



QT B412
QT B412 is a one bin design, 23-5/8" wide Each QT B412 comes with 5 DIV400 clear dividers*
*Note: Dividers shown in white color for clarity.

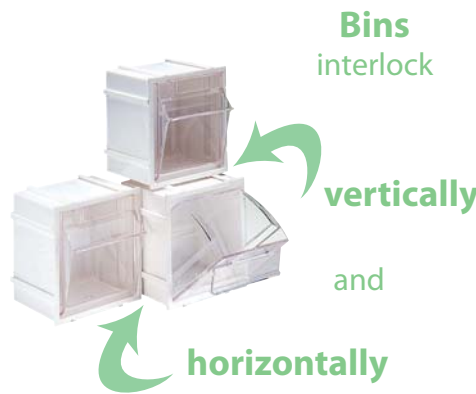

Bins interlock

vertically

and

horizontally



Dividable Tip Out Bins



These bins feature removable and adjustable dividers so that the clear bin can be partitioned into smaller compartments. Ideal for larger or longer items, these Clear Tip Out Bins are molded from the same strong and flexible material as our standard bins. The flexibility of these bins allow the user to determine the size and volume of each storage compartment. Exterior available in 3 colors. Cups are clear.

Available in: ● Ivory ● Gray ○ White

MODEL NO.	OUTSIDE DIMENSIONS L" x W" x H"	CTN QTY	CTN WGT
QT B410	5-1/4" x 11-7/8" x 5-15/16"	1	3 lbs
QT B411	5-1/4" x 23-5/8" x 5-15/16"	1	4 lbs
QT B412	5-1/4" x 23-5/8" x 5-15/16"	1	4 lbs
DIV400	Divider For Dividable Tip Out Bins	4	1 lb

PERFORMANCE FEATURES AT A GLANCE:

- Dividable Tip Out Bins are available in 3 sizes (2 with the same width)
- Bins can be stacked as modular units or used individually
- Exterior housing is injection molded from high impact Polystyrene
- Clear bin cups are injection molded from a custom blend of Phillips K Resin and Crystal Styrene for clarity and durability
- Compartments tip open smoothly to a 45° angle and provide comfortable and complete access to stored items
- The flexibility of the system allows you to customize your own system to meet your specific needs

Individual Tip Out Bins



These unique bins have the ability to interlock horizontally or vertically. Available in three popular sizes, these bins allow you to create your own customized Tip Out Bin storage system perfect for color coding.

QT B405 & QT B406 available in: ● Ivory ● Gray ○ White
QT B409 available in: ● Blue ● Red ● Yellow ○ White

MODEL NO.	OUTSIDE DIMENSIONS L" x W" x H"	CTN QTY	CTN WGT
QT B405	5-1/4" x 4-3/4" x 6-1/4"	5	6 lbs
QT B406	3-5/8" x 4-1/16" x 4-1/4"	6	4 lbs
QT B409	2-3/8" x 2-13/16" x 3"	9	3 lbs



QT B406



QT B409

Clear Tip Out Bin Floor Stands - Single, Double and Mobile
Clearly your best storage solution!

Nine pre-configured units available as pictured allowing you to purchase your Tip Out unit exactly as shown here. The flexibility of the system also allows you to customize and create your own configurations (see chart for all possibilities). All steel units are formed from heavy-duty 14 gauge steel and have a smooth powder coat finish ensuring years of use. Three different heights to choose from: 24", 48" or 70". Units are single sided, double sided or double sided mobile. Tip Out Bins are available in 3 colors. See pg. 124 for bin dimensions.

TIP OUT
BIN

QFS124-31
1 QTB304
3 QTB306
1 QTB309



QFS148-38
1 QTB302
1 QTB303
1 QTB304
1 QTB305
1 QTB306
2 QTB309



QFS170-36
4 QTB303
2 QTB304
2 QTB305
1 QTB306



COMPLETE PACKAGES
with Tip Out Bins!

QFS224-24
2 QTB303
2 QTB304
2 QTB305



QFS248-76
2 QTB302
2 QTB303
2 QTB304
2 QTB305
2 QTB306
4 QTB309



QFS270-72
8 QTB303
4 QTB304
4 QTB305
2 QTB306



Mobile Clear Tip Out Bin Floor Stands

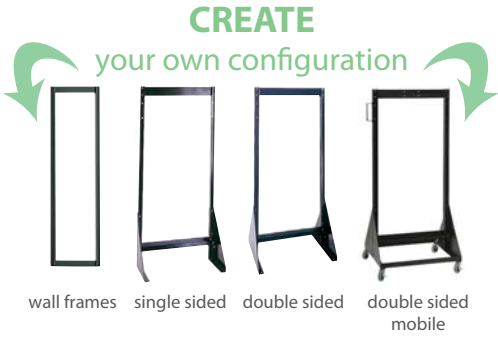

COMPLETE PACKAGES
with Tip Out Bins!

TIP OUT
BIN

QFS224-24
+ QFS400
2 QTB303
2 QTB304
2 QTB305



QFS270-72
+ QFS400
8 QTB303
4 QTB304
4 QTB305
2 QTB306



QFS248-76
+ QFS400
2 QTB302
2 QTB303
2 QTB304
2 QTB305
2 QTB306
4 QTB309



Available in: ● Ivory ● Gray ○ White

MODEL NO.	DESCRIPTION	DIMENSIONS D" x W" x H"	CTN WGT	QTY. OF BINS TO FIT UNIT								
				QTB 302	QTB 303	QTB 304	QTB 305	QTB 306	QTB 309			
Floor Stands - Single Sided (Disks and Screws Required)												
QFS124	24"H Single Sided (Workstation)	8" x 23-5/8" x 28"	11 lbs	1	2	3	3	5	8			
QFS148	48"H Single Sided	8" x 23-5/8" x 52"	19 lbs	3	5	6	7	11	16			
QFS170	70"H Single Sided	8" x 23-5/8" x 75"	20 lbs	5	7	8	10	15	23			
Floor Stands - Double Sided (Disks and Screws Required)												
QFS224	24"H Double Sided (Workstation)	16" x 23-5/8" x 28"	21 lbs	2	4	6	6	10	16			
QFS248	48"H Double Sided	16" x 23-5/8" x 52"	36 lbs	6	10	12	14	22	32			
QFS270	70"H Double Sided	16" x 23-5/8" x 75"	42 lbs	10	14	16	20	30	46			
Mobile Kit (Includes four casters and one handle)												
QFS400	Mobile Kit for Double Sided Units		9 lbs	-	-	-	-	-	-			
Disks and Screws												
QDS300	2 Disks and 2 Screws (1 set)		1 lb	-	-	-	-	-	-			

Tip Out Bins Sold Separately. 1 set of disks and screws are required per Tip Out Bin unit.

Clear Tip Out Bin Rails

Provide an easy and efficient way to build a high density expandable storage system. U-channel shaped rails allow Tip Out Bins to slide easily to any height. Each Tip Out Bin needs 2 disks and 2 screws (*QDS300*) in order to affix to all rails and frames. (*Bins are sold separately*)

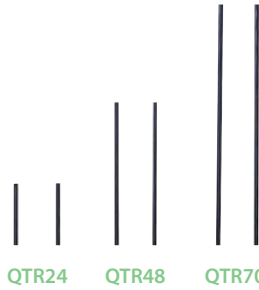

NO. OF BINS TO FIT EACH FRAME

MODEL NO.	DESCRIPTION	CTN QTY	CTN WGT	QTB 302	QTB 303	QTB 304	QTB 305	QTB 306	QTB 309
QTR24	Two 24"H Rails	1 Set	2 lbs	1	2	3	3	5	8
QTR48	Two 48"H Rails	1 Set	4 lbs	3	5	6	7	10	16
QTR70	Two 70"H Rails	1 Set	5 lbs	5	7	8	10	15	23



Utilize rails when base of the first bin will sit on the floor

HOW TIP OUT BINS affix to rails and frames



1. Having removed transparent compartments, insert screw corresponding to screw holes in Tip Out Bin housing.



2. Insert screws and screw into disk on back of Tip Out Bin housing.



3. Insert disk into frame rails.



4. Once in place, tighten screws to affix Tip Out Bin to frame rails.

Clear Tip Out Bin Frames

Frames are manufactured with preset parallel distance allowing Tip Out Bins to be stacked and removed easily and efficiently. All frames have a ledge at the bottom allowing Tip Out Bins to be secured above ground level. (*Bins are sold separately*)

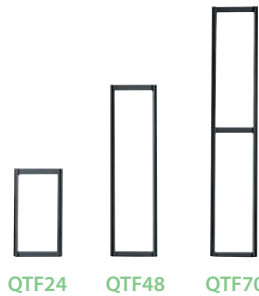

NO. OF BINS TO FIT EACH FRAME

MODEL NO.	DESCRIPTION	CTN QTY	CTN WGT	QTB 302	QTB 303	QTB 304	QTB 305	QTB 306	QTB 309
QTF24	24"H Frame	1	3 lbs	1	2	3	3	5	8
QTF48	48"H Frame	1	5 lbs	3	5	6	7	10	16
QTF70	70"H Frame	1	7 lbs	5	7	8	10	15	23



Utilize frame when bins will be mounted above floor level



QTF320-42 Complete Unit

QLR500 Locking Rod
Keeps bins from tilting open

TIP OUT BIN



QTF320 Portable Frame
(Bins sold separately)

MODEL NO.	DESCRIPTION	CTN QTY	CTN WGT
QTF320	24"W x 15"H Portable Frame Only	1	3 lbs
QDS300*	2 Disks and 2 Screws	1 Set	1 lb
QLR500	Locking Rod	1	1 lb
QTF320-42	Complete Frame Unit with Bins	1	20 lbs

* In order to attach a Tip Out Bin unit to a rail, frame or floor stand, 1 set of disks and screws are required per Tip Out Bin unit.



Available in: ● Ivory ● Gray ○ White

MODEL NO.	NO. OF BINS	NO. OF BIN CUPS
QS-304-28	28 QTB304	112
QS-305-36	36 QTB305	180
QS-306-56	56 QTB306	336
QS-309-80	80 QTB309	720
QS-305306-52	9 QTB305, 43 QTB306	303
QS-569-56	8 QTB305, 36 QTB306, 12 QTB309	364
QS-BIG-101	3 QTB302, 8 QTB303, 14 QTB304, 3 QTB305	101
QS-000	Free Stand Slider Only - NO BINS	

*All necessary hardware included with all units

TIP OUT BIN

Free Standing Slider Systems - Complete Packages

This system features four individual panels filled with tip out bins. Two are fixed to the back side of the system and two slide easily from left to right allowing free access to all four panels. Manufactured of tough 14 gauge steel with a baked enamel finish, the overall unit measures 18"D x 48"W x 77"H. (96" widths and 26" depths are available via special order). Bins are available in 3 colors.



QS-305306-52
18"D x 48"W x 77"H



QS-569-56
18"D x 48"W x 77"H



QS-BIG-101
26"D x 51-1/4"W x 77"H

Gondola Slider Systems - Complete Packages

The Gondola system provides the same versatility for orderly and efficient storage solutions in merchandising, inventory control and storing of small to medium sized parts. Slider system affixes to most standard gondolas.

Units available for purchase in the following three ways:

- Slider Frame Only (designed for fast installation on your existing 72"H Gondola). QS-725
- Slider Frame with Gondola (no Tip Out Bins) Overall Dimensions 19"D x 48"W x 75"H. G-725
- Slider Frame filled with Tip Out Bins with Gondola (five available combinations, see chart below).

Bins are available in Ivory, Gray and White.

Available in: ● Ivory ● Gray ○ White

MODEL NO.	NO. OF BINS	NO. OF BIN CUPS
QS-725	Slider Frame Only	
G-725	Slider Frame With Gondola	
G-725304-28	28 QTB304	112
G-725305-36	36 QTB305	180
G-725306-56	56 QTB306	336
G-725309-80	80 QTB309	720
G-725569-56	8 QTB305, 36 QTB306, 12 QTB309	364

*All necessary hardware included with all units

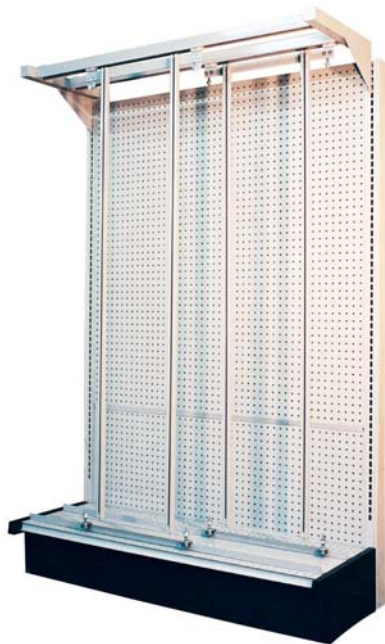

G-725
19"D x 48"W x 75"H

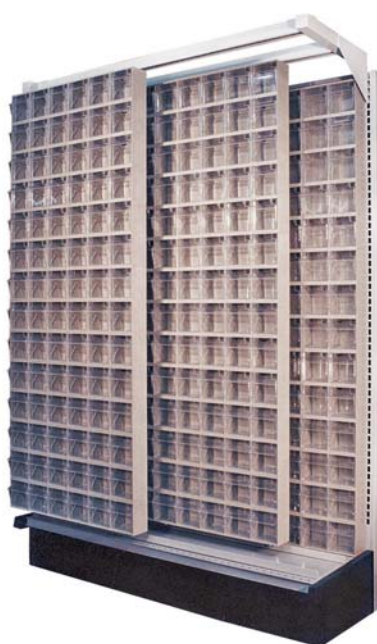

G-725306-56
19"D x 48"W x 75"H



Interlocking Storage Cabinets



Organize and store your small parts with these modular storage cabinets. Interlocking cabinets have the unique ability to interlock horizontally and vertically allowing you to customize your storage needs. Pre-drilled holes on the backside of cabinet allow for wall mounting. Cabinets are made from high impact polystyrene. Drawers are removable and will not rust or corrode. Drawers have a recessed handle and come with a slotted label holder. Drawers have seven divider slots molded in so that it may be divided into multiple compartments. Clear window allows easy identification of parts. Nine pre-configured cabinets come complete with drawers, clear windows and two dividers per drawer. Additional dividers may be purchased separately. Exterior Cabinets are available in Gray only. Drawers are available in Blue, Red, Ivory and Gray.

Cabinets have the unique ability to interlock horizontally and vertically allowing you to customize your storage needs.



Available in: ● Blue ● Red ● Ivory ● Gray

MODEL NO.	DRAWERS PER CABINET	CTN QTY	CTN WGT
QIC-161	16 IDR201	1	10 lbs
QIC-122	12 IDR202	1	10 lbs
QIC-83	8 IDR203	1	9 lbs
QIC-64	6 IDR204	1	9 lbs
QIC-8143	8 IDR201, 4 IDR203	1	10 lbs
QIC-12123	12 IDR201, 2 IDR203	1	10 lbs
QIC-4163	4 IDR201, 6 IDR203	1	10 lbs
QIC-8224	8 IDR202, 2 IDR204	1	10 lbs
QIC-4244	4 IDR202, 4 IDR204	1	10 lbs

HIGH DENSITY storage!



QIC-161

Overall Dimensions 11-3/8"D x 11-3/4"W x 11"H
Unit comes with 16 IDR201.
Available with Gray Cabinet and your choice of Gray, Blue, Red and Ivory for drawers.



QIC-122



QIC-83



QIC-64



QIC-8143



QIC-12123



QIC-4163



QIC-8224



QIC-4244

COLOR CODE your small parts!

Cabinet Drawers



Additional Drawers may be purchased separately. All drawers come complete with a clear window. Optional dividers may be purchased separately. Available in 4 colors. Please specify color.

Available in: ● Blue ● Red ● Ivory ● Gray

MODEL NO.	DIMENSIONS L" x W" x H"	CTN QTY	CTN WGT	DIVIDER	CTN QTY	CTN WGT
IDR201	11" x 2-3/4" x 2-1/2"	24	9 lbs	DIV201	25	1 lb
IDR202	11" x 2-3/4" x 3-5/16"	24	12 lbs	DIV202	25	1 lb
IDR203	11" x 5-5/8" x 2-1/2"	24	14 lbs	DIV203	25	1 lb
IDR204	11" x 5-5/8" x 3-5/16"	24	22 lbs	DIV204	25	2 lbs



PC4026-33

Also available in a 3 shelf design



PFTC4026-33-3

Also available in a 2 shelf design

**CARTS OFFER
550lb
load capacity!**

Polymer Utility Carts



Rugged, heavy-duty carts are ideal for any application. Carts will not rust, dent, chip or peel and are impervious to most chemicals, making them easy to clean. Set of 2 swivel and 2 rigid 5" x 1-1/4" heavy-duty casters allow for 550 lb. load capacity and provide a soft ride, even on rough surfaces. Comfort grip push handle allows for easy handling. Available in two sizes with a 2 or 3 shelf combination. Also available, Flat Top Shelf cart with a 2 or 3 shelf combination. All carts available in Gray.

MODEL NO.	OUTSIDE DIMENSIONS L" x W" x H"	INSIDE SHELF DIMENSIONS L" x W"	NO. OF SHELVES	SHIP WGT
PC3518-33	34-1/4" x 17-1/2" x 32-1/2"	29-1/4" x 15-1/4"	2	38 lbs
PC3518-33-3	34-1/4" x 17-1/2" x 32-1/2"	29-1/4" x 15-1/4"	3	51 lbs
PC4026-33	40" x 26" x 32-1/2"	35" x 23"	2	54 lbs
PC4026-33-3	40" x 26" x 32-1/2"	35" x 23"	3	74 lbs
Polymer Flat Top Shelf Cart				
PFTC4026-33-2	40" x 26" x 32-1/2"	35" x 23"	2	51 lbs
PFTC4026-33-3	40" x 26" x 32-1/2"	35" x 23"	3	71 lbs
Additional Shelves				
PC3518SHELF	34-1/4" x 17-1/2"	29-1/4" x 15-1/4"	1	13 lbs
PC4026SHELF	40" x 26"	35" x 23"	1	20 lbs

Shown with optional Tool Holder Accessory



PC3518-33 + PCTH

Tools not included

Tool Caddy



Industrial strength, hand-held caddy ideal for tools and supplies. This portable, high density polypropylene caddy has extra strength ribs for support. Deep compartments make transporting tools, supplies and loose parts easy. Available in Blue or Gray. 6 per carton.



TC-500

Comfortable grip handle even when carrying heavy load

Deep compartments are ideal for automotive parts, hardware or cleaning supplies



Industrial-strength polypropylene

Perfect for tools, parts and janitorial supplies!

MODEL NO.	OUTSIDE DIMENSIONS L" x W" x H"	CTN QTY	CTN WGT
TC-500	13-7/8" x 18-3/8" x 9"	6	13 lbs

Plastic Cart Tool Holder Attachment



MODEL NO.	DESCRIPTION	SHIP WGT
PCTH	96 Piece Tool Holder	3 lbs

Tool Rack



Space saving tool rack is manufactured from durable polypropylene. Get organized with this tough rack that will not warp or bend even when it is loaded to capacity. Holds up to 96 items. Mounting hardware is not included.



TR-96

MODEL NO.	OUTSIDE DIMENSIONS L" x W" x H"	CTN QTY	CTN WGT
TR-96	6" x 24-1/8" x 2-3/4"	12	12 lbs

36" Wide All-Welded Bin Cabinets



All-Purpose cabinets provide secure storage for your valuable parts and tools. Standard performance features: ships completely assembled, ready to use, 14 gauge all-welded construction, gray baked-enamel finish which ensures years of heavy-duty service, 3 point locking handle supplied with 2 keys. To order a Beige cabinet, add BG right after cabinet prefix (i.e. **QSC-BG-36** or **MESH-BG-240** or **QPR-BG-101**). Bins are available in Blue, Green, Ivory, Red, Yellow, Black and Clear. See pg. 88 for bin dimensions.

COMPLETE PACKAGES
with bins!



QSC-BG-36

36"W x 24"D x 72"H. Total of 132 bins. Deep Door Model. Ship wt. 425 lbs.
48 QUS210, 48 QUS220, 18 QUS230, 12 QUS240 and 6 QUS250.



QSC-BG-36S

36"W x 24"D x 72"H. Total of 102 bins. Deep Door Model. Ship wt. 465 lbs.
48 QUS210, 48 QUS220, 6 QUS250 and 3 adjustable shelves.



QSC-BG-64-2S-6DS

36"W x 24"D x 72"H. Total of 64 bins. Deep Door Model. Ship wt. 427 lbs.
16 QUS240, 48 QUS220, 2 adjustable interior shelves and 6 door shelves.

GRAY OR BEIGE
color!



QSC-BG-36-96-4IS

36"W x 24"D x 72"H. Total of 96 bins. Deep Door Model. Ship wt. 377 lbs.
96 QUS210 and 4 adjustable interior shelves.

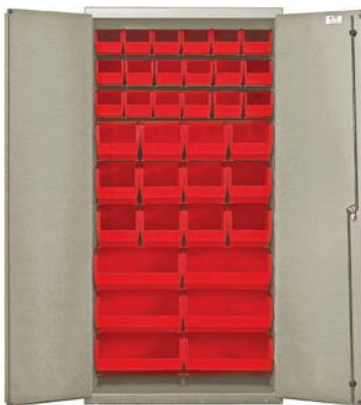

QSC-BG-36-FD

36"W x 18"D x 72"H. Total of 36 bins. Flush Door Model. Ship wt. 359 lbs.
18 QUS230, 12 QUS240 and 6 QUS250.

Perfect for
Janitorial &
Maintenance Storage



QSC-36-4IS-12DS

36"W x 24"D x 72"H. Deep Door Model. Ship wt. 308 lbs.
4 adjustable interior shelves and 12 door shelves.



QPR-101
Sloped Shelf Pick Rack Flow Cabinet
36"W x 18"D x 78"H.
Total of 72 bins. Flush Door Model. Ship wt. 298 lbs. Eight sloped shelves and one flat shelf hold **72 QSB101**. Additional cabinet configurations listed below. Bins available in Blue, Green, Ivory, Red, Yellow, Black and Clear.

MODEL NO.	NO. OF BINS	BIN MODEL	SHIP WGT
QPR-101	72	QSB101	298 lbs
QPR-102	45	QSB102	294 lbs
QPR-107	36	QSB107	289 lbs

See pg. 108 for bin dimensions.

COMPLETE PACKAGES
with bins!

MESH-240
Wire Mesh Safe-View Bin Cabinet
36"W x 18"D x 78"H.
Total of 36 bins. Mesh Door Model. Ship wt. 290 lbs. Louvered back wall fits **36 QUS240**, or additional configurations listed below. Bins available in Blue, Green, Ivory, Red, Yellow, Black and Clear.

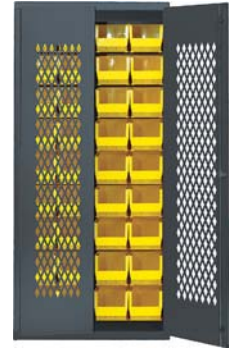

MODEL NO.	NO. OF BINS	BIN MODEL	SHIP WGT
MESH-240	36	QUS240	290 lbs
MESH-240250	20	QUS240	303 lbs
	8	QUS250	
MESH-250	18	QUS250	288 lbs

See pg. 88 for bin dimensions.

QSC-QIC161
Interlocking Drawer Storage Cabinet
48"W x 24"D x 78"H.
Total of 128 bins and 15 Interlocking Drawer Cabinets. Ship wt. 507 lbs. Louvered door fits **128 QUS210** bins (see pg. 88 for bin dimensions). Shelves hold 15 Interlocking Cabinet Units. Interlocking Cabinets have a Gray exterior, Drawers are available in Blue, Red, Ivory and Gray. Door bins available in Blue, Green, Ivory, Red, Yellow, Black and Clear.

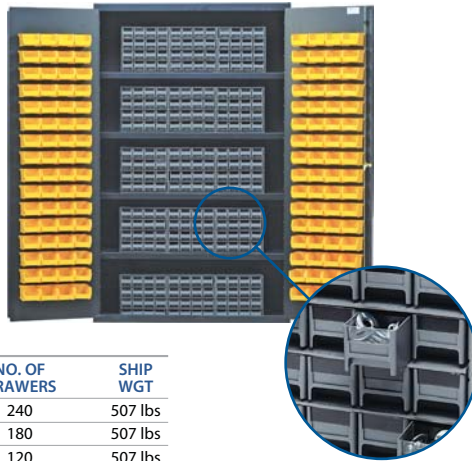

MODEL NO.	CABINET MODEL	NO. OF DRAWERS	SHIP WGT
QSC-QIC161	QIC-161	240	507 lbs
QSC-QIC122	QIC-122	180	507 lbs
QSC-QIC83	QIC-83	120	507 lbs
QSC-QIC64	QIC-64	90	507 lbs

See pg. 130 for cabinet and drawer dimensions.

QSC-C240250
Clear-View Security Bin Cabinet
36"W x 18"D x 78"H.
Total of 28 bins. Clear Door Model. Ship wt. 388 lbs. Louvered back wall fits **20 QUS240** and **8 QUS250**. Additional cabinet configurations listed below. Bins available in Blue, Green, Ivory, Red, Yellow, Black and Clear.



MODEL NO.	NO. OF BINS	BIN MODEL	SHIP WGT
QSC-C240	36	QUS240	390 lbs
QSC-C240250	20	QUS240	388 lbs
	8	QUS250	
QSC-C250	18	QUS250	392 lbs

See pg. 88 for bin dimensions.

Super-Wide Colossal Heavy-Duty Cabinets



Super-wide, colossal cabinets offer 60" widths and 84" heights allowing for maximum and efficient storage while providing superior strength and security. Standard performance features: ships completely assembled, ready to use, 14 gauge all-welded construction, gray or beige baked-enamel finish which ensures years of heavy-duty service, 3 point locking handle with provision for a padlock (not included) and 6" high legs make cabinets fork truck liftable. To order a Beige cabinet, add BG right after cabinet prefix (i.e. **QSC-BG-36** or **MESH-BG-240** or **QPR-BG-101**). Bins are available in Blue, Green, Ivory, Red, Yellow, Black and Clear. See pg. 88 for bin dimensions.

GRAY OR BEIGE
color!



QSC-BG-60
60"W x 24"D x 84"H. Total of 227 bins.
Flush Door Model. Ship wt. 860 lbs.
80 QUS210, 90 QUS220, 30 QUS230, 18 QUS240
and **9 QUS250**.



QSC-BG-60S
60"W x 24"D x 84"H. Total of 185 bins.
Flush Door Model. Ship wt. 878 lbs.
80 QUS210, 90 QUS220, 6 QUS240, 9 QUS250
and **3 adjustable shelves**.

48" Wide All-Welded Bin Cabinets



These 48" wide models offer all of the features of the 36", but with additional storage space. All cabinets are also available in Beige color. To order a Beige cabinet, add BG right after cabinet prefix (i.e. **QSC-BG-36** or **MESH-BG-240** or **QPR-BG-101**). Bins are available in Blue, Green, Ivory, Red, Yellow, Black and Clear. See pg. 88 for bin dimensions.

COMPLETE PACKAGES
with bins!

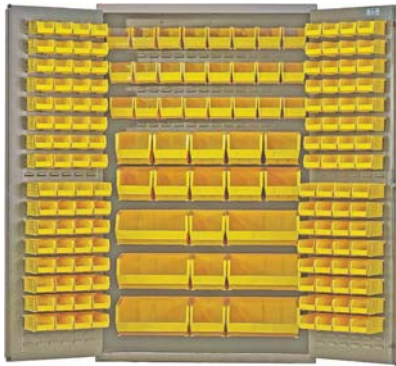

QSC-BG-48

48"W x 24"D x 78"H. Total of 171 bins. Flush Door Model. Ship wt. 522 lbs.
64 QUS210, 64 QUS220, 24 QUS230, 13 QUS240 and 6 QUS250.



QSC-BG-48S

48"W x 24"D x 78"H. Total of 137 bins. Flush Door Model. Ship wt. 534 lbs.
64 QUS210, 64 QUS220, 3 QUS240, 6 QUS250 and 3 adjustable shelves.



QSC-4803

48"W x 24"D x 78"H. Total of 128 bins. Flush Door Model. Ship wt. 505 lbs.
128 QUS210 and 4 adjustable interior shelves.

GRAY OR BEIGE
color!



QSC-4804

48"W x 24"D x 78"H. Total of 84 bins. Flush Door Model. Ship wt. 515 lbs.
20 QUS240, 64 QUS220, 2 adjustable interior shelves and 6 door shelves.



QSC-3IS

48"W x 24"D x 78"H. Flush Door Model. Ship wt. 323 lbs.
3 adjustable shelves. 800 lb. capacity per shelf.

Perfect for
Janitorial &
Maintenance Storage



QSC-4IS-14DS

48"W x 24"D x 84"H. Deep Door Model. Ship wt. 572 lbs.
4 adjustable interior shelves and 14 adjustable door shelves.
800 lb. capacity per interior shelf. 60 lb. capacity per door shelf.

Adjustable Slide Bolt Leg Work Benches

PERFORMANCE FEATURES

- Putting tasks at the correct heights improves worker comfort, and increases productivity
- Steel slide-bolt bench legs enable you to position bench tops from 29" to 37-1/2" high
- Built-in bolts secure legs within a 8" sliding range
- Leg levelers included
- Custom configurations are available, call a product specialist for details

CONSTRUCTION

- Available in Gray



- Leg levelers afford easy adaptation to uneven flooring for stability
- 9" adjustment range

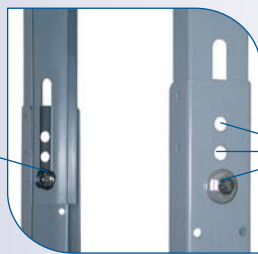

5-1/2" Infinite Adjustment

2-1/2" Fixed Adjustment

Steel Flared Leg Work Benches

PERFORMANCE FEATURES

- Leg Height is 32-1/4" high, add for top thickness
- Heavy channel steel flared legs provide sturdy base for a variety of bench work tasks
- Steel cross members welded between each upright add strength and rigidity
- Base plates punched for floor bolts provide 24 square inch floor bearing surface per leg
- Custom configurations are available, call a product specialist for details

CONSTRUCTION

- Available in Gray



LWB-3460A-HT
Hardwood - 1-3/4" Thick
Work Bench with Stringer,
Drawer & Shelf

OUTSIDE DIMENSIONS D" x W" X H"	STEEL TOP MODEL NO.	SHIP WGT	HARDWOOD TOP MODEL NO.	SHIP WGT	LAMINATE TOP MODEL NO.	SHIP WGT
29" - 37-1/2"H Adjustable Height Slide Bolt Leg Work Bench						
34" x 60" x 29"	-	-	LWB-3460A-HT	193 lbs	LWB-3460A-LT	204 lbs
34" x 72" x 29"	LWB-3472A-ST	191 lbs	LWB-3472A-HT	217 lbs	LWB-3472A-LT	229 lbs

HEAVIEST COUNTER TOP in the industry!



LWB-346032-ST
12 Gauge Steel - 1-3/4" Thick
Work Bench with Stringer,
Drawer & Shelf

OUTSIDE DIMENSIONS D" x W" X H"	STEEL TOP MODEL NO.	SHIP WGT	HARDWOOD TOP MODEL NO.	SHIP WGT	LAMINATE TOP MODEL NO.	SHIP WGT
32"H Steel Flared Leg Work Bench						
34" x 60" x 32"	LWB-346032-ST	160 lbs	LWB-346032-HT	182 lbs	LWB-346032-LT	193 lbs
34" x 72" x 32"	LWB-347232-ST	181 lbs	LWB-347232-HT	207 lbs	LWB-347232-LT	219 lbs

Bulk Storage Racks

Designed for the hand-loading of intermediate weight bulky items, this versatile rack system can be used in hundreds of storage applications. In addition to storing cartoned merchandise in shipping and receiving departments, it can be used for display racking in furniture and department stores, for storage of medical and dietary supplies in hospitals and more. Heavy-duty 14 gauge steel beams included.

OUTSIDE DIMENSIONS D" x W" x H"	STARTER MODEL NO.	SHIP WGT	ADD-ON MODEL NO.	SHIP WGT
60"H 3-Tier Bulk Storage Rack with Wire Deck				
24" x 60" x 60"	BR60-2460-3WD	151 lbs	BRA60-2460-3WD	135 lbs
24" x 72" x 60"	BR60-2472-3WD	176 lbs	BRA60-2472-3WD	161 lbs
30" x 60" x 60"	BR60-3060-3WD	168 lbs	BRA60-3060-3WD	152 lbs
30" x 72" x 60"	BR60-3072-3WD	199 lbs	BRA60-3072-3WD	183 lbs
36" x 60" x 60"	BR60-3660-3WD	189 lbs	BRA60-3660-3WD	171 lbs
36" x 72" x 60"	BR60-3672-3WD	224 lbs	BRA60-3672-3WD	204 lbs
48" x 60" x 60"	BR60-4860-3WD	223 lbs	BRA60-4860-3WD	223 lbs
48" x 72" x 60"	BR60-4872-3WD	267 lbs	BRA60-4872-3WD	249 lbs
72"H 3-Tier Bulk Storage Rack with Wire Deck				
24" x 60" x 72"	BR72-2460-3WD	156 lbs	BRA72-2460-3WD	138 lbs
24" x 72" x 72"	BR72-2472-3WD	182 lbs	BRA72-2472-3WD	164 lbs
30" x 60" x 72"	BR72-3060-3WD	179 lbs	BRA72-3060-3WD	160 lbs
30" x 72" x 72"	BR72-3072-3WD	204 lbs	BRA72-3072-3WD	185 lbs
36" x 60" x 72"	BR72-3660-3WD	191 lbs	BRA72-3660-3WD	173 lbs
36" x 72" x 72"	BR72-3672-3WD	228 lbs	BRA72-3672-3WD	208 lbs
48" x 60" x 72"	BR72-4860-3WD	229 lbs	BRA72-4860-3WD	229 lbs
48" x 72" x 72"	BR72-4872-3WD	273 lbs	BRA72-4872-3WD	252 lbs



BR60-3660-3WD
36"D x 60"W x 60" H
3-Tier Bulk Storage Rack
with Wire Decking

HEAVY-DUTY 14 GAUGE
bulk storage racks!

OUTSIDE DIMENSIONS D" x W" x H"	STARTER MODEL NO.	SHIP WGT	ADD-ON MODEL NO.	SHIP WGT
60"H 3-Tier Bulk Storage Rack with Solid Deck				
24" x 60" x 60"	-	-	-	-
24" x 72" x 60"	BR60-2472-3SD	178 lbs	BRA60-2472-3SD	163 lbs
30" x 60" x 60"	BR60-3060-3SD	167 lbs	BRA60-3060-3SD	151 lbs
30" x 72" x 60"	-	-	-	-
36" x 60" x 60"	BR60-3660-3SD	197 lbs	BRA60-3660-3SD	179 lbs
36" x 72" x 60"	BR60-3672-3SD	232 lbs	BRA60-3672-3SD	214 lbs
48" x 60" x 60"	BR60-4860-3SD	244 lbs	BRA60-4860-3SD	219 lbs
48" x 72" x 60"	BR60-4872-3SD	278 lbs	BRA60-4872-3SD	259 lbs
72"H 3-Tier Bulk Storage Rack with Solid Deck				
24" x 60" x 72"	-	-	-	-
24" x 72" x 72"	BR72-2472-3SD	183 lbs	BRA72-2472-3SD	165 lbs
30" x 60" x 72"	BR72-3060-3SD	172 lbs	BRA72-3060-3SD	154 lbs
30" x 72" x 72"	-	-	-	-
36" x 60" x 72"	BR72-3660-3SD	215 lbs	BRA72-3660-3SD	195 lbs
36" x 72" x 72"	BR72-3672-3SD	236 lbs	BRA72-3672-3SD	216 lbs
48" x 60" x 72"	BR72-4860-3SD	243 lbs	BRA72-4860-3SD	222 lbs
48" x 72" x 72"	BR72-4872-3SD	283 lbs	BRA72-4872-3SD	262 lbs



BR60-3660-3SD
36"D x 60"W x 60" H
3-Tier Bulk Storage Rack
with Solid Steel Decking



MODEL NO.	SHELF D" x W"	SHIP WGT
4 Shelf, 39"H Open Shelving Unit		
39-1236-4	12" x 36"	45 lbs
39-1836-4	18" x 36"	63 lbs
39-1842-4	18" x 42"	71 lbs
5 Shelf, 39"H Open Shelving Unit		
39-1236-5	12" x 36"	53 lbs
39-1836-5	18" x 36"	75 lbs
39-1842-5	18" x 42"	85 lbs
6 Shelf, 39"H Open Shelving Unit		
39-1236-6	12" x 36"	61 lbs
39-1836-6	18" x 36"	87 lbs
39-1842-6	18" x 42"	99 lbs
4 Shelf, 75"H Open Shelving Unit		
75-1236-4	12" x 36"	55 lbs
75-1836-4	18" x 36"	69 lbs
75-1842-4	18" x 42"	85 lbs
5 Shelf, 75"H Open Shelving Unit		
75-1236-5	12" x 36"	66 lbs
75-1836-5	18" x 36"	79 lbs
75-1842-5	18" x 42"	91 lbs
6 Shelf, 75"H Open Shelving Unit		
75-1236-6	12" x 36"	73 lbs
75-1836-6	18" x 36"	89 lbs
75-1842-6	18" x 42"	101 lbs
7 Shelf, 75"H Open Shelving Unit		
75-1236-7	12" x 36"	80 lbs
75-1836-7	18" x 36"	99 lbs
75-1842-7	18" x 42"	113 lbs
8 Shelf, 75"H Open Shelving Unit		
75-1236-8	12" x 36"	87 lbs
75-1836-8	18" x 36"	109 lbs
75-1842-8	18" x 42"	125 lbs



75-1836-6

Open & Closed Steel Shelving

- Heavy-duty, high grade shelving units are easy to clean and will not rust or corrode
- Shelving Units are 39"H or 75"H and are available in three different shelf sizes
- Shelving has a smooth powder coat finish
- 400 lb. shelf capacity



39-1836-4



MODEL NO.	SHELF D" x W"	SHIP WGT
4 Shelf, 39"H Closed Shelving Unit		
CL39-1236-4	12" x 36"	71 lbs
CL39-1836-4	18" x 36"	94 lbs
5 Shelf, 39"H Closed Shelving Unit		
CL39-1236-5	12" x 36"	79 lbs
CL39-1836-5	18" x 36"	106 lbs
6 Shelf, 39"H Closed Shelving Unit		
CL39-1236-6	12" x 36"	87 lbs
CL39-1836-6	18" x 36"	118 lbs
4 Shelf, 75"H Closed Shelving Unit		
CL75-1236-4	12" x 36"	90 lbs
CL75-1836-4	18" x 36"	115 lbs
5 Shelf, 75"H Closed Shelving Unit		
CL75-1236-5	12" x 36"	103 lbs
CL75-1836-5	18" x 36"	126 lbs
6 Shelf, 75"H Closed Shelving Unit		
CL75-1236-6	12" x 36"	110 lbs
CL75-1836-6	18" x 36"	136 lbs
7 Shelf, 75"H Closed Shelving Unit		
CL75-1236-7	12" x 36"	117 lbs
CL75-1836-7	18" x 36"	146 lbs
8 Shelf, 75"H Closed Shelving Unit		
CL75-1236-8	12" x 36"	124 lbs
CL75-1836-8	18" x 36"	156 lbs



CL75-1836-6

CLOSED SHELVING
DUST FREE & SECURE
STORAGE!



CL39-1836-4

Steel Shelving Systems - Complete Packages

These economical high density bin storage steel systems include heavy-duty giant stack bins with open hopper fronts for easy access. Optional clear windows maximize capacity, prevent spillage and convert the bin to a true tote. Optional dividers keep contents organized - available on pg. 88. Heavy-duty, high grade shelving with 400 lb. capacity per shelf. Bins available in Blue, Green, Ivory, Red, Yellow, Black and Clear.

COMPLETE PACKAGES
with bins!

Units on this page are
also available on
Wire Shelving
see pg. 91



12" Deep Systems

18" Deep Systems



QSBU-239
12"D x 36"W x 75"H
8 shelves and 28 QUS239
10-3/4"L x 8-1/4"W x 7"H bins



QSBU-240
12"D x 36"W x 75"H
8 shelves and 28 QUS240
14-3/4"L x 8-1/4"W x 7"H bins



QSBU-255
18"D x 36"W x 75"H
8 shelves and 21 QUS255
16"L x 11"W x 8"H bins
(Windows sold separately)



QSBU-260
18"D x 36"W x 75"H
6 shelves and 15 QUS260
18"L x 11"W x 10"H bins
(Windows and dividers sold separately)



QSBU-245
12"D x 36"W x 75"H
7 shelves and 24 QUS245
10-7/8"L x 16-1/2"W x 5"H bins



QSBU-250
12"D x 36"W x 75"H
8 shelves and 14 QUS250
14-3/4"L x 16-1/2"W x 7"H bins



QSBU-265
18"D x 36"W x 75"H
7 shelves and 24 QUS265
18"L x 8-1/4"W x 9"H bins



QSBU-270
18"D x 36"W x 75"H
6 shelves and 10 QUS270
18"L x 16-1/2"W x 11"H bins

Steel Shelving Systems - Complete Packages

COMPLETE PACKAGES
with bins!

Units on this side of page are also available on Wire Shelving see pg. 105

Units on this side of page are also available on Wire Shelving see pg. 107

18" Deep Systems

18" Deep Systems



QSBU-600
18"D x 36"W x 75"H
6 shelves and 15 QGH600
17-1/2"L x 10-7/8"W x 12-1/2"H bins



QSBU-600800
18"D x 36"W x 75"H
6 shelves, 6 QGH600
17-1/2"L x 10-7/8"W x 12-1/2"H bins
and 6 QGH800
17-1/2"L x 16-1/2"W x 12-1/2"H bins



MSU-16-MIX
18"D x 42"W x 75"H
7 shelves, 4 QMS543 19-3/4"L x 18-3/8"W x 11-7/8"H bins, 3 QMS533 19-3/4"L x 12-3/8"W x 11-7/8"H bins, 6 QMS532 19-3/4"L x 12-3/8"W x 7-7/8"H bins, and 3 QMS531 19-3/4"L x 12-3/8"W x 5-7/8"H bins

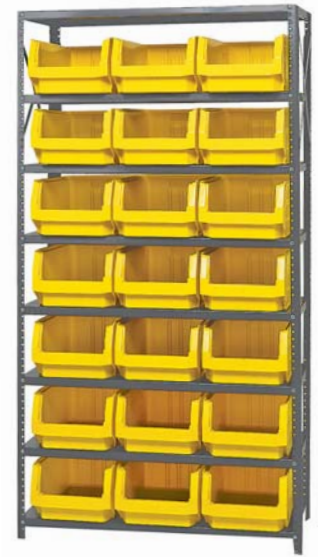

MSU-532
18"D x 42"W x 75"H
8 shelves and 21 QMS532
19-3/4"L x 12-3/8"W x 7-7/8"H bins



QSBU-700
18"D x 42"W x 75"H
6 shelves and 10 QGH700
15-1/4"L x 19-7/8"W x 12-7/16"H bins



QSBU-800
18"D x 36"W x 75"H
6 shelves and 10 QGH800
17-1/2"L x 16-1/2"W x 12-1/2"H bins



MSU-533
18"D x 42"W x 75"H
6 shelves and 15 QMS533
19-3/4"L x 12-3/8"W x 11-7/8"H bins



MSU-543
18"D x 42"W x 75"H
6 shelves and 10 QMS543
19-3/4"L x 18-3/8"W x 11-7/8"H bins



HULK 24" Container Steel Shelving Systems - Complete Packages



2475-950
24"D x 36"W x 75"H
8 shelves and 28 QUS950
23-7/8"L x 8-1/4"W x 7"H bins



2475-951
24"D x 36"W x 75"H
7 shelves and 24 QUS951
23-7/8"L x 8-1/4"W x 9"H bins



2475-952
24"D x 36"W x 75"H
8 shelves and 21 QUS952
23-7/8"L x 11"W x 7"H bins



2475-953
24"D x 36"W x 75"H
6 shelves and 15 QUS953
23-7/8"L x 11"W x 10"H bins

COMPLETE PACKAGES
with containers!

HULK
containers



Units on this page are
also available on
Wire Shelving
see pg. 99



2475-954
24"D x 36"W x 75"H
6 shelves and 10 QUS954
23-7/8"L x 16-1/2"W x 11"H bins



2475-950952
24"D x 36"W x 75"H
8 shelves and 12 QUS950
23-7/8"L x 8-1/4"W x 7"H bins
and 12 QUS952
23-7/8"L x 11"W x 7"H bins



2475-953954
24"D x 36"W x 75"H
6 shelves and 9 QUS953
23-7/8"L x 11"W x 10"H bins
and 4 QUS954
23-7/8"L x 16-1/2"W x 11"H bins



2475-20-MIX
24"D x 36"W x 75"H
7 shelves and 8 QUS950
23-7/8"L x 8-1/4"W x 7"H bins
and 3 QUS952
23-7/8"L x 11"W x 7"H bins
and 4 QUS951
23-7/8"L x 8-1/4"W x 9"H bins
and 3 QUS953
23-7/8"L x 11"W x 10"H bins
and 2 QUS954
23-7/8"L x 16-1/2"W x 11"H bins



Open and Closed Shelving Systems with Super Tuff Drawers
Complete Packages

Save time locating parts using our tough Euro Drawers with our sturdy open or closed steel shelving. 36" wide x 75" or 39" high units offer heavy-duty, high grade shelving with a 400 lb. capacity per shelf. Closed shelving provides a dust free environment for stored parts. Shelving is Gray, drawers are available in Blue, Red, Yellow or Gray.

Dust Free and Secure Storage!



CL1875-624

COMPLETE PACKAGES
with Bins!

Heavy-Density
Heavy-Duty
Storage!



1239-601
(No Side or Back Panels)

Available in: ● Blue ● Red ● Yellow ● Gray

MODEL NO.	NO. OF BINS	BIN SIZE W" x H"	SHIP WGT
Closed 12" x 36" x 75", 13 Shelf Unit			
CL1275-401*	108 QED401	5-9/16" x 2-5/8"	231
CL1275-501	108 QED501	3-3/4" x 4-5/8"	215
CL1275-601	72 QED601	5-9/16" x 4-5/8"	192
CL1275-701	48 QED701	8-3/8" x 4-5/8"	171
CL1275-801	36 QED801	11-1/8" x 4-5/8"	189
CL1275-000	UNIT - NO BINS		129
Closed 18" x 36" x 75", 13 Shelf Unit			
CL1875-602	72 QED602	5-9/16" x 4-5/8"	266
CL1875-604	108 QED604	3-3/4" x 4-5/8"	287
CL1875-624	36 QED602	5-9/16" x 4-5/8"	276
	54 QED604	3-3/4" x 4-5/8"	
CL1875-606	48 QED606	8-3/8" x 4-5/8"	237
CL1875-000	UNIT - NO BINS		167
Closed 24" x 36" x 75", 13 Shelf Unit			
CL2475-603	72 QED603	5-9/16" x 4-5/8"	360
Closed 12" x 36" x 39", 7 Shelf Unit			
CL1239-401**	54 QED401	5-9/16" x 2-5/8"	121
CL1239-601	36 QED601	5-9/16" x 4-5/8"	99
CL1239-000	UNIT - NO BINS		70
Closed 18" x 36" x 39", 7 Shelf Unit			
CL1839-602	36 QED602	5-9/16" x 4-5/8"	139
CL1839-604	54 QED604	3-3/4" x 4-5/8"	155
CL1839-624	18 QED602	5-9/16" x 4-5/8"	147
	27 QED604	3-3/4" x 4-5/8"	
CL1839-000	UNIT - NO BINS		89
Closed 24" x 36" x 39", 7 Shelf Unit			
CL2439-603	36 QED603	5-9/16" x 4-5/8"	198

* Unit includes 19 shelves. ** Unit includes 10 shelves.

MORE
ECONOMICAL
SOLUTION
compared to higher
cost steel drawer
units

HEAVY-DENSITY
HEAVY-DUTY
storage

Available in: ● Blue ● Red ● Yellow ● Gray

MODEL NO.	NO. OF BINS	BIN SIZE W" x H"	SHIP WGT
Open 12" x 36" x 75", 13 Shelf Unit			
1275-401*	108 QED401	5-9/16" x 2-5/8"	190
1275-501	108 QED501	3-3/4" x 4-5/8"	173
1275-601	72 QED601	5-9/16" x 4-5/8"	150
1275-701	48 QED701	8-3/8" x 4-5/8"	149
1275-801	36 QED801	11-1/8" x 4-5/8"	147
1275-000	UNIT - NO BINS		87
Open 18" x 36" x 75", 13 Shelf Unit			
1875-602	72 QED602	5-9/16" x 4-5/8"	213
1875-604	108 QED604	3-3/4" x 4-5/8"	245
1875-624	36 QED602	5-9/16" x 4-5/8"	229
	54 QED604	3-3/4" x 4-5/8"	
1875-606	48 QED606	8-3/8" x 4-5/8"	204
1875-000	UNIT - NO BINS		114
Open 24" x 36" x 75", 13 Shelf Unit			
2475-603	72 QED603	5-9/16" x 4-5/8"	330
Open 12" x 36" x 39", 7 Shelf Unit			
1239-401**	54 QED401	5-9/16" x 2-5/8"	100
1239-601	36 QED601	5-9/16" x 4-5/8"	78
1239-000	UNIT - NO BINS		49
Open 18" x 36" x 39", 7 Shelf Unit			
1839-602	36 QED602	5-9/16" x 4-5/8"	113
1839-604	54 QED604	3-3/4" x 4-5/8"	129
1839-624	18 QED602	5-9/16" x 4-5/8"	121
	27 QED604	3-3/4" x 4-5/8"	
1839-000	UNIT - NO BINS		63
Open 24" x 36" x 39", 7 Shelf Unit			
2439-603	36 QED603	5-9/16" x 4-5/8"	163

* Unit includes 19 shelves. ** Unit includes 10 shelves.



Shelf Bin Steel Shelving Systems
Complete Packages

Economical small parts storage steel systems keep parts easily accessible. Open hopper front bins with label area provide fast access to stored items. This all-in-one unit is easy to clean and will not rust or corrode. Heavy-duty, high grade shelving offers a 400 lb. capacity per shelf. 36" wide shelving has a smooth powder coat finish. Bins are available in Blue, Green, Ivory, Red, Yellow, Black and Clear.



1839-104

Available in: ● Blue ● Green ● Ivory ● Red ● Yellow ● Black
● Clear

MODEL NO.	NO. OF BINS	BIN SIZE L" x W" x H"	SHIP WGT
12" x 36" x 75" Unit, 13 Shelves			
1275-100	144 QSB100	11-5/8" x 2-3/4" x 4"	139 lbs
1275-101	96 QSB101	11-5/8" x 4-1/8" x 4"	117 lbs
1275-102	60 QSB102	11-5/8" x 6-5/8" x 4"	115 lbs
1275-107	48 QSB107	11-5/8" x 8-3/8" x 4"	120 lbs
1275-109	36 QSB109	11-5/8" x 11-1/8" x 4"	119 lbs
1275-000	Shelving Unit - No Bins		87 lbs
12" x 36" x 39" Unit, 7 Shelves			
1239-100	72 QSB100	11-5/8" x 2-3/4" x 4"	75 lbs
1239-101	48 QSB101	11-5/8" x 4-1/8" x 4"	67 lbs
1239-102	30 QSB102	11-5/8" x 6-5/8" x 4"	63 lbs
1239-107	24 QSB107	11-5/8" x 8-3/8" x 4"	64 lbs
1239-109	18 QSB109	11-5/8" x 11-1/8" x 4"	65 lbs
1239-000	Shelving Unit - No Bins		49 lbs
18" x 36" x 75" Unit, 13 Shelves			
1875-103	96 QSB103	17-7/8" x 4-1/8" x 4"	161 lbs
1875-104	60 QSB104	17-7/8" x 6-5/8" x 4"	155 lbs
1875-108	48 QSB108	17-7/8" x 8-3/8" x 4"	161 lbs
1875-110	36 QSB110	17-7/8" x 11-1/8" x 4"	158 lbs
1875-000	Shelving Unit - No Bins		113 lbs
18" x 36" x 39" Unit, 7 Shelves			
1839-103	48 QSB103	17-7/8" x 4-1/8" x 4"	87 lbs
1839-104	30 QSB104	17-7/8" x 6-5/8" x 4"	84 lbs
1839-108	24 QSB108	17-7/8" x 8-3/8" x 4"	87 lbs
1839-110	18 QSB110	17-7/8" x 11-1/8" x 4"	86 lbs
1839-000	Shelving Unit - No Bins		63 lbs



1275-102



REAR 'V' LOCK
enables bins to be hung from shelf above when in use



Economical small parts storage systems
keep parts easily accessible!

Color code products
to simplify order picking and inventory control!

COMPLETE PACKAGES
with bins!

Units on this page are also available on Wire Shelving
see pg. 109





Available in: ● Blue ● Green ● Ivory ● Red ● Yellow ● Black
● Clear

MODEL NO.	NO. OF BINS	BIN SIZE L" x W" x H"	SHIP WGT
BENCH RACKS 12" x 36" x 23" Unit, 3 Shelves			
QPRHA-100	36 QSB100	11-5/8" x 2-3/4" x 4"	41 lbs
QPRHA-101	24 QSB101	11-5/8" x 4-1/8" x 4"	38 lbs
QPRHA-102	15 QSB102	11-5/8" x 6-5/8" x 4"	36 lbs
QPRHA-107	12 QSB107	11-5/8" x 8-3/8" x 4"	36 lbs
QPRHA-109	9 QSB109	11-5/8" x 11-1/8" x 4"	37 lbs
QPRHA-000	BENCH RACK ONLY - NO BINS		
SINGLE SIDED RACKS 12" x 36" x 60" Unit, 8 Shelves			
QPRS-100	96 QSB100	11-5/8" x 2-3/4" x 4"	99 lbs
QPRS-101	64 QSB101	11-5/8" x 4-1/8" x 4"	85 lbs
QPRS-102	40 QSB102	11-5/8" x 6-5/8" x 4"	80 lbs
QPRS-107	32 QSB107	11-5/8" x 8-3/8" x 4"	81 lbs
QPRS-109	24 QSB109	11-5/8" x 11-1/8" x 4"	83 lbs
QPRS-000	RACK ONLY - NO BINS		
DOUBLE SIDED RACK 24" x 36" x 60" Unit, 16 Shelves			
QPRD-100	192 QSB100	11-5/8" x 2-3/4" x 4"	195 lbs
QPRD-101	128 QSB101	11-5/8" x 4-1/8" x 4"	169 lbs
QPRD-102	80 QSB102	11-5/8" x 6-5/8" x 4"	158 lbs
QPRD-107	64 QSB107	11-5/8" x 8-3/8" x 4"	160 lbs
QPRD-109	48 QSB109	11-5/8" x 11-1/8" x 4"	163 lbs
QPRD-000	RACK ONLY - NO BINS		
QDU-00	MOBILE KIT - Mobilizes all double sided units		

*All Double Sided Units available as Mobile Units with addition of Mobile Kit. Twelve QSB100, eight QSB101, five QSB102, four QSB107, three QSB109, six QUS230, three QUS235, and two QUS245 fit across a standard 36" wide pick rack shelf.

Economy Shelf Bin Sloped Shelving Systems
Complete Packages



Pick Racks provide a convenient high density, easy access, sloped shelving system, available as bench units, single and double sided free standing and mobile units. Unit comes complete with Economical Shelf Bins. Sloped shelving unit keeps small and medium sized parts easily accessible. Open hopper front bins with label area, provide fast access to stored items. This all-in-one unit is easy to clean and will not rust or corrode. See chart for configurations. Bins are available in Blue, Green, Ivory, Red, Yellow, Black and Clear. One bin color per unit.



QPRHA-102
Bench Pick Rack
250 lb. capacity.

SLOPED SHELVES! EASY ACCESS!
Most Popular & Versatile Storage Systems Sold!



QPRD-102 + QDU-00
Mobile, Double Sided Pick Rack
1,000 lb. capacity.



QPRD-107
Double Sided Pick Rack
800 lb. capacity.



QPRS-101
Single Sided Pick Rack
400 lb. capacity.



Single & Double Sided Rail Units
Complete Packages

Single Sided Unit: 36"L x 15"W x 53"H. 250 lb. capacity. Available in 4 different configurations.

Double Sided Unit: 36"L x 20"W x 53"H. 500 lb. capacity. Available in 4 different configurations. Mobilize double sided unit with the addition of **QRU-MOB**. Bins are available in Blue, Green, Ivory, Red, Yellow, Black and Clear.

QRU-16S-220230240



Bench Racks - Complete Packages

Bench Racks: 36"L x 8"W x 19"H and 27"L x 8"W x 21"H. Both bench racks are available in 3 pre-configured choices. Bench racks can be joined together to form continuous systems. Bins are available in Blue, Green, Ivory, Red, Yellow, Black and Clear.

QBR-3619-210-32



Louvered Panel - Complete Packages

Louvered Panels: 18"L x 19"H, 36"L x 19"H, 36"L x 61"H and 48"L x 61"H. Each available in 3 configurations. Louvered Panels are available in Gray or Oyster White color. To order a Oyster White Louvered Panel add HC to the model number (i.e. **QLP-1819HC-210-18**). Bins are available in Blue, Green, Ivory, Red, Yellow, Black and Clear.

QLP-1819-220-16



Mobile Double Sided Louvered Rack Unit
Complete Packages

Louvered Rack Unit: 36"L x 25"W x 72"H Mobile unit 1,200 lb. capacity. Bins available in Blue, Green, Ivory, Red, Yellow, Black and Clear.

QMD-36H-230240



MODEL NO.	NO. OF BINS	BIN DIMENSION L" x W" x H"	SHIP WGT
Single Sided Rail System 36"L x 15"W x 53"H With Bins			
QRU-12S-220-96	96	7-3/8" x 4-1/8" x 3"	82 lbs
QRU-16S-230-48	48	10-7/8" x 5-1/2" x 5"	108 lbs
QRU-12S-240-24	24	14-3/4" x 8-1/4" x 7"	102 lbs
	16	7-3/8" x 4-1/8" x 3"	
QRU-16S-220230240	18	10-7/8" x 5-1/2" x 5"	108 lbs
	12	14-3/4" x 8-1/4" x 7"	
Double Sided Rail System 36"L x 20"W x 53"H With Bins			
QRU-12D-220-192	192	7-3/8" x 4-1/8" x 3"	113 lbs
QRU-16D-230-96	96	10-7/8" x 5-1/2" x 5"	155 lbs
QRU-12D-240-48	48	14-3/4" x 8-1/4" x 7"	153 lbs
QRU-MOB		Mobilizes double sided units	25 lbs

MODEL NO.	NO. OF BINS	BIN DIMENSIONS L" x W" x H"	SHIP WGT
Bench Rack 27"L x 8"W x 21"H With Bins			
QBR-2721-210-24	24	5-3/8" x 4-1/8" x 3"	23 lbs
QBR-2721-220-24	24	7-3/8" x 4-1/8" x 3"	25 lbs
QBR-2721-230-12	12	10-7/8" x 5-1/2" x 5"	28 lbs
Bench Rack 36"L x 8"W x 19"H With Bins			
QBR-3619-210-32	32	5-3/8" x 4-1/8" x 3"	29 lbs
QBR-3619-220-32	32	7-3/8" x 4-1/8" x 3"	31 lbs
QBR-3619-230-18	18	10-7/8" x 5-1/2" x 5"	37 lbs

MODEL NO.	NO. OF BINS	BIN DIMENSIONS L" x W" x H"	SHIP WGT
Louvered Panel 18"L x 19"H With Bins			
QLP-1819-210-16	16	5-3/8" x 4-1/8" x 3"	11 lbs
QLP-1819-220-16	16	7-3/8" x 4-1/8" x 3"	12 lbs
QLP-1819-230-9	9	10-7/8" x 5-1/2" x 5"	16 lbs
Louvered Panel 36"L x 19"H With Bins			
QLP-3619-210-32	32	5-3/8" x 4-1/8" x 3"	22 lbs
QLP-3619-220-32	32	7-3/8" x 4-1/8" x 3"	24 lbs
QLP-3619-230-18	18	10-7/8" x 5-1/2" x 5"	30 lbs
Louvered Panel 36"L x 61"H With Bins			
QLP-3661-220-120	120	7-3/8" x 4-1/8" x 3"	80 lbs
QLP-3661-230-60	60	10-7/8" x 5-1/2" x 5"	90 lbs
QLP-3661-240-28	28	14-3/4" x 8-1/4" x 7"	96 lbs
Louvered Panel 48"L x 61"H With Bins			
QLP-4861-220-165	165	7-3/8" x 4-1/8" x 3"	115 lbs
QLP-4861-230-80	80	10-7/8" x 5-1/2" x 5"	127 lbs
QLP-4861-240-35	35	14-3/4" x 8-1/4" x 7"	130 lbs

MODEL NO.	NO. OF BINS	BIN DIMENSIONS L" x W" x H"	SHIP WGT
QMD-36H-220	240	7-3/8" x 4-1/8" x 3"	174 lbs
QMD-36H-230	120	10-7/8" x 5-1/2" x 5"	212 lbs
QMD-36H-240	56	14-3/4" x 8-1/4" x 7"	208 lbs
	72	10-7/8" x 5-1/2" x 5"	
QMD-36H-230240	24	14-3/4" x 8-1/4" x 7"	217 lbs

COMPLETE PACKAGES
with bins!



MODEL NO	PG.	3036P - 3072P.....	38	BL36 - BL72.....	77	DSB201 - DSB216.....	110	M1836C47RE-5 - M2460C47RE-5...	55
1 1006DHB - 1606DHB.....	9	3036S - 3072S.....	38	BL36S - BL72S.....	77	DSB801 - DSB816.....	112	M1836CG46 - M2460CG46.....	52
1017HBC - 1035HBC.....	7	362412DPP - 963612DPP.....	73, 118	BLH3C - BLH32C.....	48	DSS401 - DSS405.....	96	M1836CG46-5 - M2460CG46-5.....	53
1224C - 1272C.....	38	362412DPS - 963612DPS.....	73, 118	BR60-2460-3WD.....		DUS200 - DUS270.....	88	M1836CG46RE - M2460CG46RE....	56
1236P - 1272P.....	38	3636C - 3672C.....	36BR72-4872-3WD	136	DUS950 - DUS955.....	98	M1836CG46RE-5.....	
1236S - 1272S.....	38	3636P - 3672P.....	36	BR60-2472-3SD.....		DUS970 - DUS976.....	100M2460CG46RE-5	57
1239-000 - 1239-109.....	142	3636S - 3672S.....	36BR72-4872-3SD	136	DUS993 - DUS997.....	100	M1836CG47 - M2460CG47.....	52
1239-401 - 1239-601.....	141	36BH - 60BH.....	75	BRA60-2460-3WD.....		DWB14 - DWB24.....	14	M1836CG47-5 - M2460CG47-5.....	53
1275-000 - 1275-109.....	142	39-1236-4 - 39-1842-6.....	137BRA72-4872-3WD	136	E EL-12406.....	73	M1836CG47RE - M2460CG47RE....	56
1275-401 - 1275-801.....	141	5 52RT - 84RT.....	56-57	BRA60-2472-3SD.....		ELH410 - ELH445.....	108, 110	M1836CG47RE-5.....	
149DC - 2012DC.....	15, 48	7 75-1236-4 - 75-1842-8.....	137BRA72-4872-3SD	136	EP126 - EP228.....	76M2460CG47RE-5	57
1424C - 1472C.....	38	A AD54-1236C - AD54-3672C.....	40	BSK1824C - BSK2460C.....	50	EP126S - EP228S.....	76	M1836SG46 - M2460SG46.....	52
1430S - 1472S.....	38	AD54-1236C-5 - AD54-3672C-5.....	40	C CAN-34-36BH-230.....	15	ESD-DC - ESD-SS.....	78	M1836SG46-5 - M2460SG46-5.....	53
1436BC - 204812BC.....	48	AD54-1236P - AD54-3672P.....	40	CAN-34-48BH-230.....	15	F FG - FP.....	78	M1836SG47 - M2460SG47.....	52
1436P - 1472P.....	38	AD54-1236P-5 - AD54-3672P-5.....	40	CAN-34-60BH-230.....	15	G G-725.....	129	M1836SG47-5 - M2460SG47-5.....	53
1436SG - 1472SG.....	39	AD54-1236S - AD54-3672S.....	40	CAN-34-1436BC-PWB.....	15	G-725304-28.....	129	M1836SL34C-M2448SL34C.....	62
1436SS - 1472SS.....	39	AD54-1236S-5 - AD54-3672S-5.....	40	CAN-34-1448BC-PWB.....	15	G-725305-36.....	129	M1836SL6C - M2448SL6C.....	62
1617HBC - 1635HBC.....	7	AD54-1436SG - AD54-2472SG.....	46	CAN-34-203612BC-PWB.....	15	G-725306-56.....	129	M2036BD - M2048BD.....	48
1824C - 1872C.....	38	AD54-1436SG-5 - AD54-2472SG-5.....	47	CAN-34-2036BC-PWB.....	15	G-725309-80.....	129	M2430CLAN.....	123
1824S - 1872S.....	38	AD63-1236C - AD63-3672C.....	41	CAN-34-204812BC-PWB.....	15	G-725569-56.....	129	M2436-69SEC - M2460-69SEC.....	60
1824SG - 1872SG.....	39	AD63-1236C-5 - AD63-3672C-5.....	41	CAN-34-2048BC-PWB.....	15	GR24 - GR60.....	78	M2436C46E - M2460C46E.....	54
1824SS - 1872SS.....	39	AD63-1236P - AD63-3672P.....	41	CB14 - CB24.....	14	GSP-2448 - GSP-2472.....	13	M2436C46E-5 - M2460C46E-5.....	55
1826TR.....	72	AD63-1236P-5 - AD63-3672P-5.....	41	CC183663 - CC247263.....	61	GSP-5HOOK-16.....	13	MD1836C46RE - MD2460C46RE....	54
1830P - 1872P.....	38	AD63-1236S - AD63-3672S.....	41	CC183663CV - CC247263CV.....	61	GSP-B12128.....	13	MD1836C46RE-5.....	
183614DE - 246014DE.....	74	AD63-1236S-5 - AD63-3672S-5.....	41	CC183674 - CC247274.....	61	GSP-HOOK6.....	13MD2460C46RE-5	55
183614PC - 246014PC.....	74	AD63-1436SG - AD63-2472SG.....	46	CC183674CV - CC247274CV.....	61	GSP-HOOK10.....	13	MD1836CG46RE.....	
183634DE - 246034DE.....	74	AD63-1436SG-5 - AD63-2472SG-5.....	47	CD965 - CD1887.....	114	GSP-SB12128.....	13MD2460CG46RE	56
183654DE - 246054DE.....	74	AD74-1236C - AD74-3672C.....	42	CL1239-000 - CL1239-601.....	141	GSP-SS2215.....	13	MD1836CG46RE-5.....	
1836BC6C - 2448BC6C.....	49	AD74-1236C-5 - AD74-3672C-5.....	42	CL1275-000 - CL1275-801.....	141	GSP-WMHD.....	13MD2460CG46RE-5	57
1836DS - 2460DS.....	75	AD74-1236P - AD74-3672P.....	42	CL1839-000 - CL1839-624.....	141	H HANDLE-DLY.....	106, 120	MD1836C47RE - MD2460C47RE....	54
1836FC - 2460FC.....	75	AD74-1236P-5 - AD74-3672P-5.....	42	CL1875-000 - CL1875-624.....	141	HB18C - HB60C.....	76	MD1836C47RE-5.....	
1836FE - 2460FE.....	75	AD74-1236S - AD74-3672S.....	42	CL2439-603 - CL2475-603.....	141	HB18S - HB60S.....	76MD2460C47RE-5	55
1836FS - 2460FS.....	75	AD74-1236S-5 - AD74-3672S-5.....	42	CL39-1236-4 - CL39-1836-6.....	137	HBL3C - HBL32C.....	9	MD1836CG47RE.....	
1836SL - 2448SL.....	75	AD74-1436SG - AD74-2472SG.....	46	CL75-1236-4 - CL75-1836-8.....	137	HD18 - HD36.....	68MD2460CG47RE	56
1836SL6C - 2448SL6C.....	60	AD74-1436SG-5 - AD74-2472SG-5.....	47	COV210 - COV240.....	88	HD18-2 - HD36-3.....	69	MD1836CG47RE-5.....	
1836SM - 2472SM.....	77	AD86-1236C - AD86-3672C.....	43	COV91000 - COV93000CL.....	117	HNS006.....	95MD2460CG47RE-5	57
1839-000 - 1839-110.....	142	AD86-1236C-5 - AD86-3672C-5.....	43	D DB.....	79	HNS200 - HNS230.....	95	MD2436-70SEC - MD2460-70SEC.....	60
1839-602 - 1839-624.....	141	AD86-1236P - AD86-3672P.....	43	DB1836C - DB2460C.....	76	I IDR201 - IDR204.....	130	MESH-240 - MESH-250.....	133
1875-000 - 1875-110.....	142	AD86-1236P-5 - AD86-3672P-5.....	43	DB1836S - DB2460S.....	76	K KEYBD.....	78	MSU-16-MIX.....	139
1875-602 - 1875-624.....	141	AD86-1236S - AD86-3672S.....	43	DCB14 - DCB24.....	14	L LBL2X8 - LBL5X8.....	117	MSU-532 - MSU-543.....	139
18-M-HAMP.....	34	AD86-1236S-5 - AD86-3672S-5.....	43	DCC91000CL - DDC93000CL.....	117	LD965 - LD1887.....	114	MWR4-2419-9.....	119
18TB - 36TB.....	77	AD86-1436SG - AD86-2472SG.....	46	DDS-24.....	76	LGH700.....	104	MWR5-1711-12.....	119
2 2026TRGY - 2026TRWT.....	72	AD86-1436SG-5 - AD86-2472SG-5.....	47	DG91035 - DG93120.....	117	LH3B.....	76	MWR7-1711-8.....	119
2124C - 2172C.....	38	A-MC-AA34-33369.....	25	DG91035CL - DG93120CL.....	82	LH3C - LH69C.....	76	MWRS-5-92035 - MWRS-5-92080....	62
2124S - 2172S.....	38	A-MC-AA39-33369.....	27	DH8.....	77	LHA3C.....	76	MWRS-7-103 - MWRS-7-110.....	62
2124SG - 2172SG.....	39	A-MC-CB.....	27	DIV12 - DIV36.....	77	LID1711 - LID2516-8.....	120	MWRS-7-602 MWRS-7-606.....	62
2124SS - 2172SS.....	39	A-MC-IV.....	27	DIV12S - DIV36S.....	77	LID181 - LID301.....	118	P P6C - P96C.....	39
2130P - 2172P.....	38	A-MC-OTH.....	27	DIV18SL - DIV24SL.....	75	LTR-0813.....	87	P6P - P86P.....	39
2424C - 2472C.....	38	A-MC-PR.....	25	DIV201 - DIV204.....	130	LTR-1253 - LTR-2400.....	87	P6S - P86S.....	39
2424S - 2472S.....	38	A-MC-SUH.....	27	DIV303 - DIV304.....	124	LWB-3460A-HT - LWB-3472A-ST.....	135	PC3518-33 - PC3518-33-3.....	33, 131
2424SG - 2472SG.....	39	B BC212434M1 - BC212434M1CL.....	66	DIV400.....	125	LWB-34603-HT - LWB-347232-ST.....	135	PC3518SHELF.....	33, 131
2424SS - 2472SS.....	39	BC212439M2 - BC212439M2CL.....	66	DIV401 - DIV801.....	116	M M18366DE - M24606DE.....	74	PC4026-33 - PC4026-33-3.....	33, 131
2430P - 2472P.....	38	BC212469M1 - BC212469M1CL.....	66	DL91035 - DL93120.....	117	M1836BC6C - M2448BC6C.....	49	PC4026SHELF.....	33, 131
243660EPC - 246060EPC.....	60	BC212469M2 - BC212469M2CL.....	66	DLT-6.....	87	M1836C46 - M2460C46.....	52	PCL1 - PCL2.....	77
2436-63SEC.....	60	BC212469M - BC212469M1.....	66	DLY-2415.....	122	M1836C46-5 - M2460C46-5.....	53	PC18366DE - M24606DE.....	74
2439-603 - 2475-603.....	141	BC212439M4 - BC212439M7.....	66	DLY-3018.....	106, 120	M1836C46RE - M2460C46RE.....	54	PFTC4026-33-2 - PFTC4026-33-3... 33, 131	
2448-63SEC.....	60	BC214045M1D - BC214045M14D.....	67	DMS531 - DMS543.....	106	M1836C46RE-5 - M2460C46RE-5.....	55	PH18 - PH36.....	77
2460-63SEC.....	60	BC214069M1D - BC214069M22D.....	67	DS18-24.....	76	M1836C47 - M2460C47.....	52	PH18S - PH36S.....	77
2475-20-MIX - 2475-954.....	140	BC216045M1T - BC216045M21T.....	67	DS91035 - DS93120.....	117	M1836C47-5 - M2460C47-5.....	53	PS-A2475-7S.....	17
3 3036C - 3072C.....	38	BC216069M1T - BC216069M33T.....	67	DSB101 - DSB116.....	108	M1836C47RE - M2460C47RE.....	54	PS-A2475-8PT.....	17

PS-A2475-8WB.....	17	QFS124 - QFS270.....	127	QMS533.....	106	QSC-QIC122.....	133	QUS955.....	98
PS-DBC-14PT.....	19	QFS124-31.....	126	QMS543.....	106	QSC-QIC161.....	133	QUS955CL.....	81
PS-DBC-7WB7S.....	19	QFS148-38.....	126	QMS743.....	106	QSC-QIC64.....	133	QUS964MOB.....	98
PS-DC2214.....	20	QFS170-36.....	126	QMS843MOB.....	106	QSC-QIC83.....	133	QUS964MOBCL.....	81
PS-P1874-1A7.....	22	QFS224-24+QFS400.....	127	QP965 - QP1887.....	114	QSMC.....	44-47	QUS965MOB.....	98
PS-P2674-1A9.....	22	QFS224-24.....	126	QPR-101 - QPR-107.....	133	QTB301 - QTB309.....	124	QUS965MOBCL.....	81
PS-PA1874-1A7.....	22	QFS248-76+QFS400.....	127	QPRD-000 - QPRD-109.....	143	QTB405 - QTB412.....	125	QUS970.....	100
PS-PA674-1A9.....	22	QFS248-76.....	126	QPRHA-000 - QPRHA-109.....	143	QTB-LP-BKT.....	124	QUS973.....	100
PS-PD2674-2A8T6S.....	23	QFS270-72+QFS400.....	127	QPRS-000 - QPRS-109.....	143	QTF24 - QTF70.....	128	QUS974.....	100
PS-PDBC-18.....	21	QFS270-72.....	126	QRB166 - QRB256MOB.....	103	QTF320.....	128	QUS975.....	100
PS-PDH.....	20	QFS400.....	127	QRU-12D.....	95	QTF320-42.....	128	QUS976.....	100
PS-PDL.....	20	QGH600.....	104	QRU-12D-220-192.....	144	QTR24 - QTR70.....	128	QUS984MOB.....	100
PS-PLD2 - PS-PLD8.....	20	QGH600CL.....	83	QRU-12D-240-28.....	144	QUS200.....	88	QUS985MOB.....	100
PS-PLH.....	20	QGH700.....	104	QRU-12S.....	95	QUS200CL.....	80	QUS986MOB.....	100
PS-PMT16244 - PS-PMT16248.....	20,23	QGH700CL.....	83	QRU-12S-220-96.....	144	QUS210.....	88	QUS993.....	100
PS-PSBC-9.....	21	QGH705MOB.....	104	QRU-12S-240-24.....	144	QUS210CL.....	80	QUS994MOB.....	100
PS-PSD2 - PS-PSD8.....	20	QGH705MOBCL.....	83	QRU-16D.....	95	QUS220.....	88	QUS995.....	100
PS-PT16242 - PS-PT16244.....	20,23	QGH800.....	104	QRU-16D-230-96.....	144	QUS220CL.....	80	QUS996MOB.....	100
PS-PT2674-2A18T5S.....	23	QGH800CL.....	83	QRU-16S.....	95	QUS221.....	88	QUS997.....	100
PS-PTS.....	20	QGH805MOB.....	104	QRU-16S-220230240.....	144	QUS221CL.....	80	QUS998MOB.....	100
PS-S2475-7S.....	17	QGH805MOBCL.....	83	QRU-16S-230-48.....	144	QUS224.....	88	QVTRK.....	68
PS-S2475-8PT.....	17	QIC-12123.....	130	QRU-1W.....	95	QUS224CL.....	80	QVTRK-2-72EST.....	
PS-S2475-8WB.....	17	QIC-122.....	130	QRU-MOB.....	95,144	QUS230.....	88QVTRK-3-240EST	69
PS-SBC58-6PT.....	18	QIC-161.....	130	QS-000.....	129	QUS230CL.....	80	S SCH1 - SCH1-5.....	49,76
PS-SBC58-6S.....	18	QIC-4163.....	130	QS-304-28.....	129	QUS234.....	88	SD36C - SD60C.....	60
PS-SBC58-6WB.....	18	QIC-4244.....	130	QS-305306-56.....	129	QUS234CL.....	80	S-HOOK.....	78
PS-SE - PS-SSE.....	20	QIC-64.....	130	QS-305-36.....	129	QUS235.....	88	SL12 - SL30.....	77
PS-TS22184C.....	20	QIC-8143.....	130	QS-306-56.....	129	QUS235CL.....	80	SL12S - SL30S.....	77
PS-TS22184WT.....	20	QIC-8224.....	130	QS-309-80.....	129	QUS239.....	88	S-MC-A36-6666.....	27
PS-WB22143 - PSWB22148.....	20	QIC-83.....	130	QS-569-56.....	129	QUS239CL.....	80	S-MC-A4080G-20.....	29
PS-WBLD-3 - PS-WBLD-8.....	20	QLP-1819 - QLP-1819HC.....	12,94	QS-725.....	129	QUS240.....	88	S-MC-A42G-9.....	28
PS-WBSD-3 - PS-WBSD-8.....	20	QLP-1819-210-16.....		QSB100 - QSB116.....	108	QUS240CL.....	80	S-MC-A5780G-12.....	29
PS-WS2414.....	20QLP-1819-230-9	144	QSB100CL - QSB116CL.....	84	QUS241.....	88	S-MC-A60-CSC10.....	30
PT-NR.....	79	QLP-1861 - QLP-1861HC.....	12,94	QSB201 - QSB216.....	110	QUS241CL.....	80	S-MC-A60-SC16.....	30
PT-NS.....	79	QLP-2721.....	12,94	QSB201CL - QSB216CL.....	85	QUS242.....	88	S-MC-A60G-15.....	29
PT-PR.....	79	QLP-3612.....	12,94	QSB801 - QSB816.....	112	QUS242CL.....	80	S-MC-A70GL-9.....	28
PT-PR6.....	79	QLP-3619 - QLP-3619HC.....	12,94	QSB801CL - QSB816CL.....	86	QUS245.....	88	S-MC-A70GR-9.....	28
PT-PS.....	79	QLP-3619-210-32.....		QS-BIG-101.....	129	QUS245CL.....	80	S-MC-A7480G-12.....	29
PT-PS6.....	79QLP-3619-230-18	144	QSBU-239 - QSBU-270.....	138	QUS250.....	88	S-MC-CAP.....	27
PT-PSB.....	79	QLP-3661 - QLP-3661HC.....	12,94	QSBU-600.....	139	QUS250CL.....	80	S-MC-S1GBH.....	29
PT-PSB6.....	79	QLP-3661-220-120.....		QSBU-600800.....	139	QUS255.....	88	S-MC-SCH.....	28,29
PWB.....	14QLP-3661-240-28	144	QSBU-700.....	139	QUS255CL.....	80	S-MC-SESR.....	29
Q QB900.....	123	QLP-4819.....	12,94	QSBU-800.....	139	QUS260.....	88	S-MC-SFWS.....	29
QBC111 - QBC112.....	108,110	QLP-4861 - QLP-4861HC.....	12,94	QSC-36-4IS-12DS.....	132	QUS260CL.....	80	S-MC-SSC.....	29
QBR-2721-210-24.....		QLP-4861-220-165.....		QSC-3IS.....	133	QUS265.....	88	S-MC-SWB.....	29
.....QBR-3619-230-18	144QLP-4861-240-35	144	QSC-4803.....	133	QUS265CL.....	80	snh010.....	118,120
QDC2012-7.....	122	QLR500.....	124,128	QSC-4804.....	133	QUS270.....	88	snt180 - snt300.....	118
QDC2115-12.....	122	QMB510C.....	10,92	QSC-4IS-14DS.....	133	QUS270CL.....	80	SSB423 - SSB485.....	96
QDC2115-17.....	122	QMB520C.....	10,92	QSC-BG-36.....	132	QUS275MOB.....	88	S-SC-182448B-5.....	30
QDC2115-9.....	122	QMB530C.....	10,92	QSC-BG-36-96-4IS.....	132	QUS275MOBCL.....	80	S-SC-182460B-5.....	30
QDC2213-12.....	122	QMB535C.....	10,92	QSC-BG-36-FD.....	132	QUS950.....	98	S-SC-182492E-10.....	30
QDC2420-12.....	122	QMB539C.....	10,92	QSC-BG-36S.....	132	QUS950CL.....	81	S-SC-182492E-5.....	30
QDC2515-14.....	122	QMB540C.....	10,92	QSC-BG-48.....	133	QUS951.....	98	S-SC-1836-1S5D7CM.....	31
QDC2717-12.....	122	QMB550C.....	10,92	QSC-BG-48S.....	133	QUS951CL.....	81	S-SC-1836-1S5DBC.....	31
QDC2820-15.....	122	QMB560C.....	10,92	QSC-BG-60.....	133	QUS952.....	98	S-SC-1836-1S7CM.....	31
QDL-2115.....	122	QMB570C.....	10,92	QSC-BG-60S.....	133	QUS952CL.....	81	S-SC-1836-6S4CM.....	31
QDS300.....	127,128	QMD-36H-220.....		QSC-BG-64-2S-6DS.....	132	QUS953.....	98	S-SC-183692E-16.....	30
QDU-00.....	143QMD-36H-240	144	QSC-C240.....	133	QUS953CL.....	81	S-SC-183692E-8.....	30
QED401 - QED801.....	116	QMS531.....	106	QSC-C240250.....	133	QUS954.....	98	S-SC-1842-1S7CM.....	31
QESTP.....	68	QMS532.....	106	QSC-C250.....	133	QUS954CL.....	81		

S-SC-1842-1S7D9CM.....	31	WR12-101 - WR12-116.....	109	WR6-974.....	101	WR86-1436SG - WR86-2472SG..	46	WRCSL5-63-1836-104.....	
S-SC-1842-1S7DBC.....	31	WR12-101CL - WR12-116CL.....	84	WR7-20-MIX.....	99	WR86-1436SG-5.....	WRCSL5-63-2448-106	63
S-SC-1842-5S25D.....	31	WR12-93030.....	119	WR7-20-MIXCL.....	81WR86-2472SG-5	47WRCSL5-63-1836EP-104.....	
S-SC-1842-6S4CM.....	31	WR12-93030CL.....	82	WR7-245CL.....	80	WR8-801 - WR8-816.....	113WRCSL5-63-2448EP-106	63
S-SC-184292E-18.....	30	WR-3.....	79	WR74-1236C - WR74-3672C.....	42	WR8-801CL - WR8-816CL.....	86	WRCSL5-74-1836-104220.....	63
S-SC-184292E-9.....	30	WR4-12225.....	119	WR74-1236C-5 - WR74-3672C-5..	42	WR8-950 - WR8-952.....	99	WRCSL5-74-1836-104230.....	63
S-SC-2436-1S5D7CM.....	31	WR4-39-1236-801.....		WR74-1236P - WR74-3672P.....	42	WR8-950CL - WR8-952CL.....	81	WRCSL5-74-1848-104220.....	63
S-SC-2436-1S7CM.....	31WR4-39-1236-809	113	WR74-1236P-5 - WR74-3672P-5..	42	WR8-970.....	101	WRC-SW2448.....	34
S-SC-2436-2S4D22.....	31WR4-39-1236-801CL		WR74-1236S - WR74-3672S.....	42	WR9-201 - WR9-216.....	111	WR-D24W.....	67
S-SC-2436-5S25D.....	31WR4-39-1236-809CL	86	WR74-1236S-5 - WR74-3672S-5..	42	WR9-201CL - WR9-216CL.....	85	WRDBS4-63-2436EP.....	
S-SC-HFVU.....	30	WR5-270.....	91	WR74-1248-101102.....	64	WR9-36180.....	119WRDBS4-74-2460EP	58
SST-2436U - SST-2472U.....	35	WR5-270CL.....	80	WR74-1248-110101.....	64	WR9-531.....	107WRDBS4-63-2436EP-5.....	
SST-MOB.....	35	WR5-36MSBA.....	48	WR74-1248-66102.....	64	WR9-92060 - WR9-93060.....	119WRDBS4-74-2460EP-5	59
T TBC-32WT.....	124	WR5-36MSBA-MOB.....	48	WR74-1260-101102.....	64	WR9-92060CL - WR9-93060CL..	82	WRGR-63-2436 - WRGR-63-2460..	51
TC-19 - TC-39.....	72	WR5-39-1236-201.....		WR74-1260-143101.....	64	WRA86-2136C-166.....		WR-PS.....	79
TC-500.....	123,131WR5-39-1236-209	111	WR74-1260-88102.....	64WRA86-2172C-246	103	WR-RG.....	79
TR1-2516-8 - TR6-2516-8.....	121	WR5-39-1236-201CL.....		WR74-1272-101102.....	64	WRC-1836-2 - WRC-1836-2G....	32	WR-S24W.....	66-67
TR-96.....	131WR5-39-1236-209CL	85	WR74-1272-110102.....	64	WRC-1836-3 - WRC-1836-3G....	32	WRS4-54-1436SS.....	
TS32C - TS62C.....	72	WR54-1236C - WR54-3672C.....	40	WR74-1272-176101.....	64	WRC-1842-2 - WRC-1842-2G....	32WRS4-86-2472SS	44
TTK-8 - TTK-21.....	71	WR54-1236C-5 - WR54-3672C-5..	40	WR74-1436SG - WR74-2472SG..	46	WRC-1842-3 - WRC-1842-3G....	32	WRS5-54-1436SS.....	
TTK-C18 - TTK-C24.....	71	WR54-1236P - WR54-3672P.....	40WR74-2472SG-5	47	WRC-1848-2 - WRC-1848-2G....	32WRS5-86-2472SS	45
TTK-E18 - TTK-E24.....	71	WR54-1236P-5 - WR54-3672P-5..	40	WR74-1848-103104.....	64	WRC-1848-3 - WRC-1848-3G....	32	WRS-5-92035 - WRS-5-92080.....	62
TTK-M18 - TTK-M24.....	71	WR54-1236S - WR54-3672S.....	40	WR74-1848-110103.....	64	WRC2-1836-1265.....		WRS-7-103 - WRS-7-110.....	62
TUB1711-12.....	120	WR54-1236S-5 - WR54-3672S-5..	40	WR74-1848-66104.....	64WRC2-1836-1887	115	WRS-7-602 - WRS-7-606.....	62
TUB1711-8.....	120	WR54-1436SG - WR54-2472SG..	46	WR74-1860-103104.....	64	WRC2-36-3036-976.....	36	WRSAD4-54-1436SS.....	
TUB2417-12.....	120	WR54-1436SG-5.....		WR74-1860-103104.....	64	WRC-2436-2 - WRC-2436-2G....	32WRADS4-86-2472SS	44
TUB2417-8.....	120WR54-2472SG-5-47		WR74-1860-143103.....	64	WRC-2436-3 - WRC-2436-3G....	32	WRSAD5-54-1436SS-5.....	
TUB2419-9.....	120	WR5-533.....	107	WR74-1860-88104.....	64	WRC-2442-2 - WRC-2442-2G....	32WRADSS-86-2472SS-5	45
TUB2516-8.....	120	WR5-543.....	107	WR74-1872-103104.....	64	WRC-2442-3 - WRC-2442-3G....	32	WRSC3-42-2436FS.....	35
U UB10.....	78	WR5-600 - WR5-800.....	105	WR74-1872-110104.....	64	WRC-2448-2 - WRC-2448-2G....	32	WRSC3-42-2448FS.....	35
UH18 - UH24.....	77	WR5-800CL - WR5-800CL.....	83	WR74-1872-176103.....	64	WRC-2448-3 - WRC-2448-3G....	32	WRSC3-42-2460FS.....	35
UH18S - UH24S.....	77	WR5-955.....	99	WR74-2448-105106.....	64	WRC2-63-3036-974976.....	36	WRSC4-54-2436FS.....	35
W W7-12-24 - W7-18-30.....	115	WR5-955CL.....	81	WR74-2448-110105.....	64	WRC3-1836-1265.....		WRSC4-54-2448FS.....	35
WGH600 - WGH800.....	83,104	WR5-975.....	101	WR74-2448-66106.....	64WRC3-1836-1887	115	WRSC4-54-2460FS.....	35
WK.....	68	WR5-993 - WR5-997.....	102	WR74-2460-105106.....	64	WRC5-63-2436-93060.....	66	WR-SP.....	77
WLP-1836C.....	11,93	WR6-13-MIX.....	107	WR74-2460-143105.....	64	WRC5-63-2436-93060CL.....	66	WR-SS - WR-SSCO.....	77
WLP-3036C.....	11,93	WR6-24185.....	119	WR74-2460-88106.....	64	WRC5-63-2448-93060.....	66	WR-WMB.....	77
WLP-3048C.....	11,93	WR6-260.....	91	WR74-2472-105106.....	64	WRC5-63-2448-93060CL.....	66	WS-1218DSHC - WS-1248DSHC..	9
WLP-DMC - WLP-OSC.....	11,93	WR6-260CL.....	80	WR74-2472-110106.....	64	WRC5-63-2460-93060.....	66	WS-1818DSHC - WS-1848DSHC..	9
W-MC-232436-5.....	24	WR6-265CL.....	80	WR74-2472-176105.....	64	WRC5-63-2460-93060CL.....	66	WS-DR10C.....	9
W-MC-AB42-33669.....	26	WR63-1236C - WR63-3672C.....	41	WR7-532.....	107	WRC74-1824CSG-5BSK.....		WS-DS18ADHC - WS-DS18HC.....	7
W-MC-AC45-333669.....	24	WR63-1236C-5 - WR63-3672C-5..	41	WR7-92080.....	119WRC74-2460CSG-5BSK	50	WS-DS36ADHC - WS-DS36HC.....	7
W-MC-CBB.....	24	WR63-1236P - WR63-3672P.....	41	WR7-92080CL.....	82	WRC9-63-2448-105.....	65	WS-DS48ADHC - WS-DS48HC.....	7
W-MC-CR.....	25	WR63-1236P-5 - WR63-3672P-5..	41	WR7-951.....	99	WRC-BC2448.....	65	WS-HB36HC - WS-HB48HC.....	9
W-MC-GBH.....	25	WR63-1236S - WR63-3672S.....	41	WR7-951CL.....	81	WRCGR-63-2436.....	51	WS-HBB - WS-HBBA.....	9
W-MC-IV.....	24	WR63-1236S-5 - WR63-3672S-5..	41	WR8-239.....	91	WRCGR-63-2448.....	51	WS-HDS6 - WS-HDS12.....	9
W-MC-OTB.....	24	WR63-1436SG - WR63-2472SG..	46	WR8-239CL.....	80	WRCGR-63-2460.....	51	WS-HTH.....	9
W-MC-SH.....	25	WR63-1436SG-5.....		WR8-240.....	91	WR-CH.....	65	WS-PM18HC - WS-PM48HC.....	7
W-MC-SI43-4699.....	25WR63-2472SG-5	47	WR8-240CL.....	80	WRC-IT1824.....	32	WS-SR9C.....	9
W-MC-SR1.....	24	WR6-36-1236-101.....		WR8-250.....	91	WRC-LPSW1863.....	34	WS-SS18-4S3L - WS-SS18-7S.....	8
W-MC-SP43-43669.....	26WR6-36-1236-109	109	WR8-250CL.....	80	WRCPL-63-2460.....	51	WS-SS18ADHC - WS-SS18HC.....	7
WMS531 - WMS543.....	106WR6-36-1236-101CL		WR8-255.....	91	WRCPL-63-2460-955.....	36	WS-SS36-4S3L - WS-SS36-7S.....	8
W-PC-STUD.....	39WR6-36-1236-109CL	84	WR8-255CL.....	80	WRCS4-63-2436EP.....		WS-SS36ADHC - WS-SS36HC.....	7
W-PLB.....	39	WR6-953.....	99	WR8-423 - WR8-485.....	97WRCS4-74-2460EP	58	WS-SS48ADHC - WS-SS48HC.....	7
W-PLI.....	39	WR6-953CL.....	81	WR86-1236C - WR86-3672C.....	43WRCS4-63-2436EP-5.....		WS-VTH.....	9
WR-00CO.....	79	WR6-953954CL.....	81	WR86-1236C-5 - WR86-3672C-5..	43WRCS4-74-2460EP-5	59	WUS221 - WUS270.....	88
WR-00H.....	79	WR6-954.....	99	WR86-1236P - WR86-3672P.....	43	WRCSL5-63-1836.....		WUS950 - WUS955.....	98
WR-00HS.....	79	WR6-954CL.....	81	WR86-1236P-5 - WR86-3672P-5..	43WRCSL5-63-1836	63	WUS970 - WUS976.....	100
WR10-230240.....	91	WR6-973.....	101	WR86-1236S - WR86-3672S.....	43	WRCSL5-63-1836EP.....			
WR10-230240CL.....	80	WR6-973974.....	101	WR86-1236S-5 - WR86-3672S-5..	43WRCSL5-63-2448EP	63		

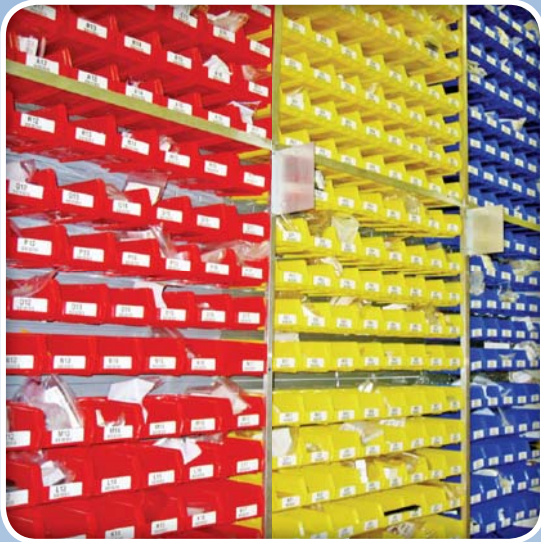

CORPORATE HEADQUARTERS

15800 NW 15th Avenue
Miami, Florida 33169

HEALTHCARE CORPORATE HEADQUARTERS / SHOWROOM

508 Autumn Springs Court
Suite 1D
Franklin, TN 37067

Toll-Free
1-877-742-2467
Fax
1-877-742-2497



sales@quantummedical.com
www.quantummedical.com

HEALTHCARE STORAGE SOLUTIONS

- *New Construction & Expansion*
- *Materials Management & Supply Chain*
- *Sterile Processing & Supply*
- *Surgical Services*
- *Cath Lab, Endoscopy, IR and more*
- *Design Assistance & Installation Services*