



# ENGINEERED HIGH DENSITY STORAGE SYSTEMS





# TABLE OF CONTENTS

## WHY CHOOSE MONTEL?

WHY CHOOSE MONTEL?	PAGE 5
OUR MISSION	PAGE 6
INTERNATIONAL PRESENCE	PAGE 7
STORAGE SYSTEMS COMPARISON CHART	PAGE 8
THE CONCEPT	PAGE 9
RETURN ON INVESTMENT	PAGE 10
MOBILE STORAGE SYSTEM BENEFITS	PAGE 14
LEADERSHIP IN ENERGY AND ENVIRONMENT DESIGN (LEED)	PAGE 15

## APPLICATIONS

INDUSTRIES	PAGE 16
COLD STORAGE	PAGE 18

## STORAGE SOLUTIONS

STORAGE SOLUTIONS	PAGE 21
MOBILE STORAGE SYSTEMS	PAGE 22
QUADRAL MODULAR SLIDING LATERAL STORAGE - 750 LB PER LINEAR FOOT	
SMARTSPACE 2M, 2M PLUS MANUAL MOBILE STORAGE - 2,000 LB PER BAY	
SMARTSPACE 2MA, 2MA PLUS MECHANICAL-ASSIST MOBILE STORAGE - 2,000 LB PER BAY	
SMARTSPACE 2P, 2P PLUS POWERED MOBILE STORAGE - 2,000 LB PER BAY	
MOBILEX® MECHANICAL-ASSIST MOBILE STORAGE - 1,000 LB PER LINEAR FOOT	
SAFEAISLE® POWERED MOBILE STORAGE - 1,000 LB PER LINEAR FOOT	
RACK&ROLL 16MA MECHANICAL-ASSIST MOBILE STORAGE - 16,000 LB PER DOUBLE BAY	
RACK&ROLL 16P POWERED MOBILE STORAGE - 16,000 LB PER DOUBLE BAY	
SAFERAK® 32P POWERED MOBILE STORAGE - 32,000 LB PER DOUBLE BAY	
SAFERAK® 60P POWERED MOBILE STORAGE - 60,000 LB PER DOUBLE BAY	
SHELVING SYSTEMS	PAGE 24
SMARTSHELF® 4-POST HYBRID SHELVING	
CABINET-STYLE CAS E-TYPE SHELVING	
4D WIDE SPAN RACKING - 500 LB, 1,000 LB, 1,500 LB PER TIER	
HI-BAY HIGH-BAY WAREHOUSE SHELVING - 800 LB PER SHELF	
SHELVING WITH DRAWERS	PAGE 26

## STORAGE SOLUTIONS (CONTINUING)

CABINETS	PAGE 28
LIGHT-DUTY CABINETS - HINGED DOORS	
HEAVY-DUTY CABINETS - HINGED SINGLE DOOR	
HEAVY-DUTY CABINETS - HINGED DOUBLE DOORS	
LIGHT-DUTY DRAWER CABINETS	
HEAVY-DUTY DRAWER CABINETS	
HEAVY-DUTY MOBILE DRAWER CABINETS	
WORKBENCHES	PAGE 30
HANGING STORAGE SCREENS	PAGE 32
PULL-OUT HANGING STORAGE SYSTEMS	
MOBILE HANGING STORAGE SCREEN SYSTEMS	
HANGING STORAGE PANELS	PAGE 34

## SAFETIES

MANUAL SAFETY SMARTSPACE 2M	PAGE 36
MECHANICAL-ASSIST SAFETIES SMARTSPACE 2MA, MOBILEX®, RACK&ROLL 16MA	PAGE 36
POWERED SAFETIES SMARTSPACE 2P, SAFEAISLE®, RACK&ROLL 16P	PAGE 37
POWERED SAFETIES SAFERAK® 32P, SAFERAK® 60P	PAGE 38
aisle LED GUARD™ ADVANCED SAFETY SAFERAK® 32P, SAFERAK® 60P	PAGE 39

## PRODUCTIVITY & TECHNOLOGY

EPULSE™ REMOTE MONITORING SOFTWARE	PAGE 40
EPULSE™ REMOTE MONITORING PACKAGES	PAGE 42
PROGRAMMABLE AISLE AUTOMATED FEATURES	PAGE 44

## CASE STUDIES

AIRBUS	PAGE 48
IMMUNOTEC	PAGE 50
ACURA DEALERSHIP	PAGE 52
HONDA	PAGE 54
THE GROVE	PAGE 56
WILLIAMS SELYEM WINERY	PAGE 58
HYATT	PAGE 60
US ARMY	PAGE 62



# WHY CHOOSE MONTEL INDUSTRIAL STORAGE SOLUTIONS?



## GET RESULTS FROM YOUR SQUARE FOOTAGE: FAST ROI

Save up to 50% of your value generating space.



## WORK WITH STORAGE-SAVVY EXPERTS

We manufacture the one and only solution. The best one.



## TOTAL OFFER CUSTOMIZED TO YOUR NEEDS

We will go to any length, depth, width or height.



## BETTER ORGANIZE YOUR SKUs

Gain productivity while inventory management & security are improved.



## MEET YOUR ENVIRONMENTAL OBJECTIVES

Minimize your environmental impact by reducing and optimizing your footprint.

# OUR MISSION

## THE EMPLOYEES OF MONTEL SET OUT A VERY PERSONAL OBJECTIVE: BUILD THE BEST STORAGE SYSTEMS IN THE WORLD.

Their talent, commitment and dedication have been put to the test numerous times.

At Montel, client satisfaction is an ongoing priority. Our highly competent Authorized Montel Distributors are specialists in providing turnkey project solutions including space planning, design and floor loading consulting services, and factory certified system installations. They are also committed to providing a high level of professionalism and an outstanding customer service before and after the sale.

From the first contact to the completion of a project, we spare no effort to meet the requirements of our clients.

Today, the name of Montel is synonymous of excellence around the world in high density storage systems. For more information about our products and services, or to receive information about your local Authorized Montel Distributor, please visit us at [www.montel.com](http://www.montel.com).

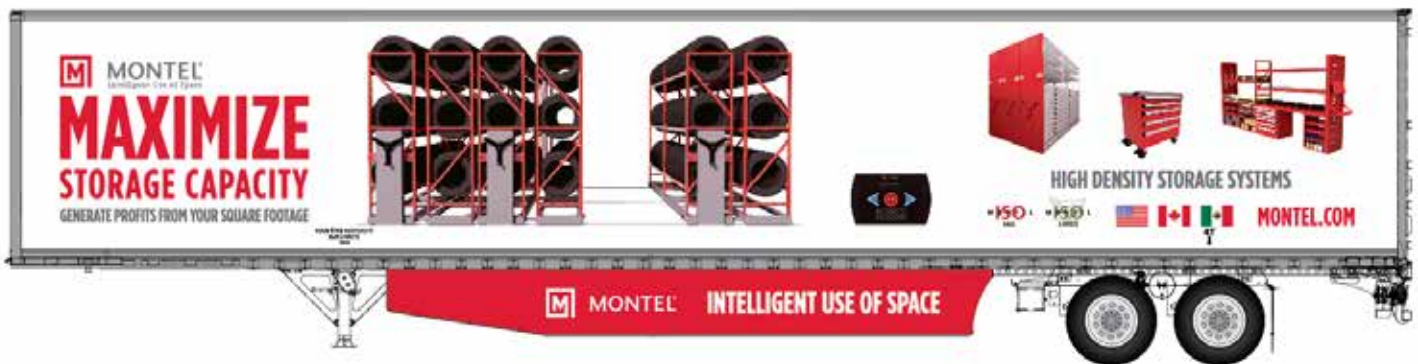

# MONTEL INTERNATIONAL PRESENCE



\* Montel achieved numerous realizations in more than 68 countries.

Established in 1924, Montel pioneered high density mobile storage systems providing cost-efficient storage solutions using less space, and established a global network of certified Montel distributors. Montel's achievements include realizations in more than 68 countries through its network of distribution, and even in areas without a local authorized Montel distributor.

**68**  
**COUNTRIES**

MONTEL ACHIEVED  
PRESTIGIOUS  
REALIZATIONS  
IN MORE THAN  
68 COUNTRIES

**65**  
**DISTRIBUTORS**

65 AUTHORIZED  
MONTEL  
DISTRIBUTORS  
AROUND  
THE WORLD

**SINCE**  
**1924**

MORE  
THAN  
9 DECADES  
OF KNOW-HOW

# PALLET RACKING STORAGE SYSTEMS

## CHART FOR 5,000 PALLETS

PALLET RACKING STORAGE SYSTEMS	 <b>UNRIVALED OPTIMUM SOLUTION</b> MONTEL MOBILE RACKING	STATIONARY RACKING	NARROW AISLE RACKING	DRIVE-IN RACKING	DRIVE-IN RACKING	PUSH BACK RACKING
	 FLOOR SPACE REQUIRED IN SQUARE FEET	22K MINIMAL FLOOR SPACE REQUIRED	41K	32K	31K	37K
 VOLUME REQUIRED IN CUBIC FEET	795K MOST INTELLIGENT USE OF VOLUME	1.483M	1.139M	1.082M	1.395M	1.196M
 INVESTMENT	\$\$\$ BEST ROI	\$	\$	\$\$	\$\$\$\$\$\$	\$\$\$\$\$\$
 FLOW TYPE & ACCESSIBILITY	FIFO FULL ACCESS	FIFO FULL ACCESS	FIFO FULL ACCESS	FILO LIMITED ACCESS	FILO LIMITED ACCESS	FILO/FIFO FULL ACCESS
 INVENTORY ROTATION ADAPTABILITY	ADAPTABLE	ADAPTABLE	ADAPTABLE	ADAPTABLE	NOT ADAPTABLE	NOT ADAPTABLE
 PALLET HANDLING & STOCK PROTECTION	★★★★★ LEAST DAMAGES TO SUPPLIES	★★★★★	★★★★★	★	★	★★
	<b>UNRIVALED OPTIMUM SOLUTION</b>					





# THE CONCEPT

## OPTIMIZE YOUR STORAGE SPACE

MONTEL HIGH DENSITY STORAGE SYSTEMS MAXIMIZE THE USE OF AVAILABLE SPACE, WHETHER TO INCREASE STORAGE CAPACITY, FREE UP ROOM FOR PRODUCTION OR OTHER USES, OR GET RID OF SPACE YOU DO NOT NEED TO PAY FOR.

### ELIMINATE THE NEED FOR MULTIPLE SPACE-WASTING STATIC AISLES. HERE IS HOW:

1. Static units are mounted on mobile carriages.
2. Mobile carriages travel on tracks.
3. Use the handle to move the manual systems or turn the 3-spoke SafeCrank handle for mechanical-assist systems or push a button on the powered system control to open the desired aisle.



**WASTED SPACE CONVENTIONAL FIXED RACKING LAYOUT.**

Conventional storage systems require space-wasting fixed aisles.

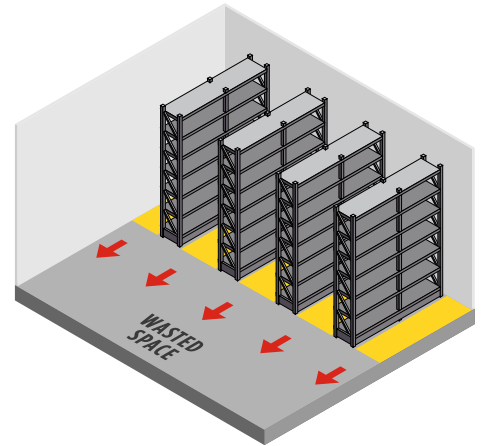

### MODES OF OPERATION



Manual mobile storage systems handle.



3-spoke ergonomically designed rotating SafeCrank handle with soft-touch knobs for mechanical-assist mobile storage systems. Aisle safety push-button located at the core of the 3-spoke SafeCrank handle.



Powered mobile storage systems control.



Powered mobile storage systems control with PIN for restricted access.



LCD touchscreen tablet control with or without PIN. Limitless customized displays.

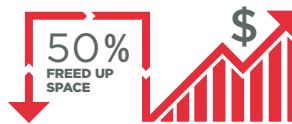

**SPACE SAVED & INCREASED PROFITS MOBILE STORAGE LAYOUT.**

Montel's high-density storage systems save up to 50% of your floor space in most cases, and accommodate growth for other uses while increasing revenue.

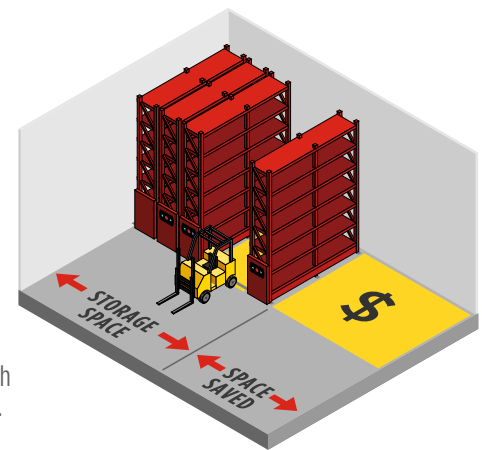

**DOUBLED STORAGE CAPACITY. MAXIMIZED SPACE & INCREASED PROFITS MOBILE LAYOUT.**

100% greater storage capacity within the original floor space, eliminating the need for a costly expansion or the construction of a new facility.

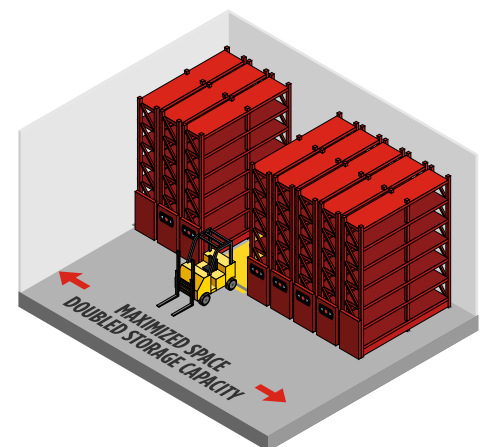

# ROI IS FAST

NO SHREWD INVESTOR DROPS THEIR HARD-EARNED MONEY ON BREAKTHROUGH TECHNOLOGY WITHOUT CONSIDERING ITS VIABILITY. WILL SPENDING ON AN INNOVATION LIKE HIGH DENSITY MOBILE RACKING TODAY BE A LUCRATIVE BUSINESS VENTURE TOMORROW?

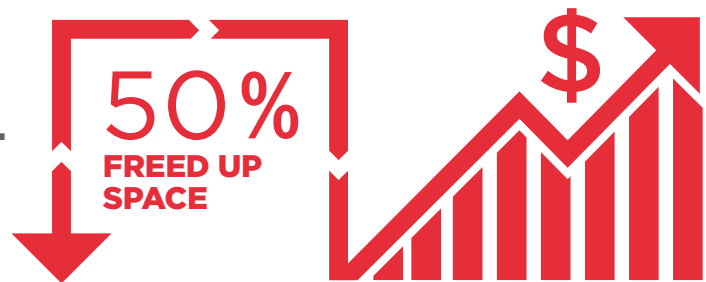

## 1. WHEN A BUSINESS CAN HOLD MORE, IT CAN DO MORE

Businesses know space can be a valuable commodity, regardless of industry. For retailers and manufacturers, a diverse product line requires places for all the additional SKUs they're charged with managing. For warehouses, extra room means extra opportunities to bring in new business and reap the benefits of demand-based vacancy rates.

«High density mobile racking systems imbue businesses with a greater sense of spatial economics». High density mobile shelving and industrial racking technology reclaims space otherwise occupied by aisles that more often than not go unused.

That means as much as 50 percent of an industrial storage area equipped with static shelving is literally squandered on space that's hardly used. Mobile racking installations can either shrink the overall storage footprint to allow for greater on-site operational freedom or effectively double a company's storage capacity without physically expanding. In either case, high density mobile racking systems imbue businesses with a greater sense of spatial economics that provides financial benefits year over year.



# 2.

## BUSINESSES STAY QUICK WITH HIGH DENSITY MOBILE RACKING

Can mobile racking systems really keep pace with the speed of modern business? Competitive markets call for investments that accelerate operations, streamline processes and eliminate waste. Outfitting an industrial facility with high density mobile racking installations not only improves logistical throughput but can push companies to make more intelligent, data-minded decisions about how they conduct business.

Mobile shelving coupled with optional e-Pulse remote monitoring technology works with logistics teams to isolate increased traffic areas and restructure their legacy organizational strategies around adopting more comprehensive zoning and picking methods supported by the mobile racking technology. With ePulse software, managers and supervisors can track facility movement, examine which products receive the most attention and make small adjustments accordingly.

### WHAT CAN YOUR BUSINESS DO WITH THE NEW FREED UP SPACE?

# 3.

## INNOVATING INSTEAD OF RENOVATING

Building on more room to a facility may improve gross production capabilities, but when one takes into account increases to energy footprint, construction costs and labor mandates – not to mention property rental costs, insurance, taxes and maintenance – who knows when that addition will actually return real value to the company?

When a warehouse or other storage facility has seemingly run out of space, expansion seems like the only solution. Thanks to mobile storage, it isn't even a contender.

On the other hand, research conducted by Montel distributor revealed mobile storage modules installed throughout 18,000 square feet of reclaimed warehouse space would pay for itself in under two years and return more than \$1.1 million in avoided costs after a decade of use.

Instead of increasing their size or spending money on fleeting managerial fads, businesses should simply strive to utilize the space they have more efficiently. To that end, investment in high density mobile racking systems is an investment in how well a company operates and keeps costs to a minimum.



# COST OF MONTEL MOBILE STORAGE SYSTEM VS. ANNUAL COST OF WAREHOUSE RENT

## ESTIMATED WAREHOUSE LEASE – ILLINOIS PRODUCT: SAFERAK® 32P MOBILE RACKING



MONTEL SAFERAK® 32P  
MOBILE RACKING

<b>ANNUAL WAREHOUSE RENT</b>	
Lease per sq ft	<b>\$7.00</b>
HVAC Cost per sq ft	<b>\$1.50</b>
Warehouse Taxes & Maintenance	<b>\$0.75</b>
<b>Total Annual Lease Per sq ft</b>	<b>\$9.25/sq ft</b>

	<b>ROI IN 22 MONTHS</b>
Montel Mobile Storage System Investment*	<b>\$240,000</b>
Recovered Warehouse Space	<b>14,000 sq ft</b>
Yearly Rent on Freed Up Space (14,000 sq ft x \$7.00 annual rent per sq ft)	\$98,000
HVAC & Utilities (14,000 x \$1.50 annual cost per sq ft)	\$21,000
Insurance, Maintenance, Taxes (14,000 sq ft x \$0.75 annual cost per sq ft)	\$10,500
<b>Total Savings in Leasing per Year</b>	<b>\$129,500</b>
<b>ROI</b>	<b>22 Months</b>
<b>ROI AFTER 10 YEAR = (\$129,500 x 10 Years) - \$240,000</b>	<b>\$1,295,000</b>

Warehouse costs were too expensive compared to a Montel mobilized racking solution.

\* Pricing includes mobile system and installation cost.

# COST OF MONTEL MOBILE STORAGE SYSTEM VS. ANNUAL COST OF STOCKROOM RENT

**ESTIMATED COMMERCIAL LEASE – TOMBALL, TX  
PRODUCT: MOBILEX® WITH 4D WIDE SPAN**



MONTEL MOBILEX®  
WITH 4D WIDE SPAN RACKING

<b>ANNUAL STOCKROOM RENT</b>	
Lease per sq ft	<b>\$17.00</b>
HVAC Cost per sq ft	<b>\$1.50</b>
Stockroom Taxes & Maintenance	<b>\$0.50</b>
<b>Total Annual Lease Per sq ft</b>	<b>\$19.00/sq ft</b>

Source: LoopNet - <http://www.loopnet.com/Listing/19079406/27400-State-Highway-249-Tomball-TX/>

	<b>ROI IN 28 MONTHS</b>
Montel Mobile Storage System Investment*	<b>\$16,800</b>
Recovered Warehouse Space	<b>382 sq ft</b>
Yearly Rent on Freed Up Space (382 sq ft. x \$17 annual rent per sq ft)	\$6,494
HVAC & Utilities (382 x \$1.50 annual cost per sq ft)	\$573
Insurance, Maintenance, Taxes (382 sq ft x \$0.50 annual cost per sq ft)	\$191
<b>Total Savings in Leasing per Year</b>	<b>\$7,258</b>
<b>ROI</b>	<b>28 Months</b>
<b>ROI AFTER 10 YEARS = (\$7,258 x 10 Years) - \$16,800</b>	<b>\$55,780</b>

Warehouse costs were too expensive compared to a Montel mobilized racking solution.

\* Pricing includes mobile system and installation cost.

# YOUR CURRENT WAREHOUSE FEES ARE TOO EXPENSIVE WHEN COMPARED TO A MOBILIZED RACKING SOLUTION.

## HIGH-DENSITY MOBILE STORAGE SYSTEM BENEFITS

- Freed up valuable floor space for receiving area without increasing stockroom footprint
- Improved circulation paths for personnel and material handling equipment
- Added stockroom organization, security and cleanliness of working environment
- Enhanced overall efficiency and productivity as materials are more organized – easier for brand inventory control
- Eliminated the need for costly outside storage containers

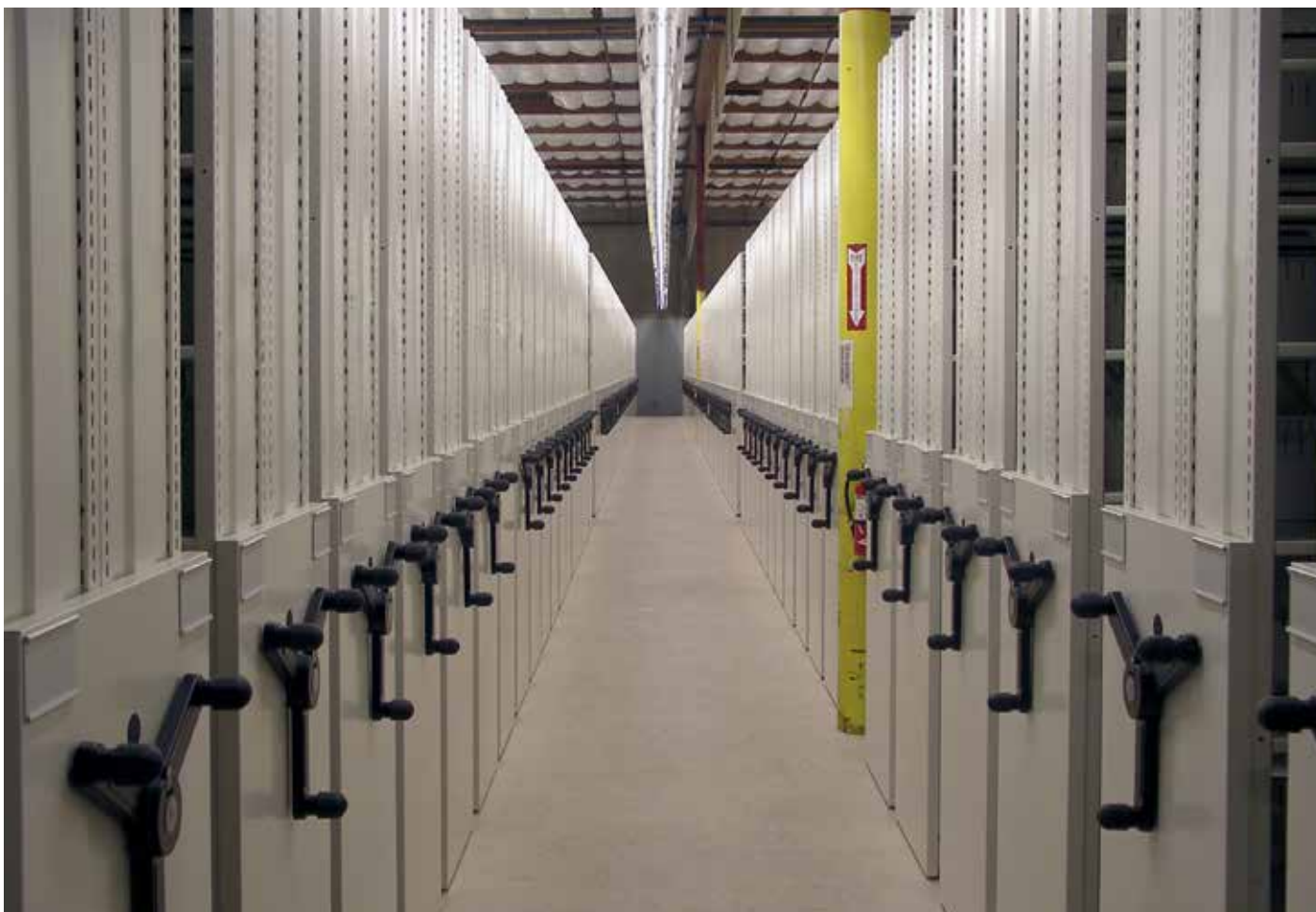

# LEADERSHIP IN ENERGY AND ENVIRONMENTAL DESIGN (LEED®) GREEN BUILDING RATING SYSTEMS IN NORTH AMERICA.

This document explores the potential contribution for the use of MONTEL HIGH DENSITY STORAGE SYSTEMS for a LEED® (New Construction and Major Renovations) project. The LEED® Rating System has 110 points divided in seventeen topics for certifying the design and construction of commercial or institutional buildings and high-rise residential buildings of all sizes, both public and private. Montel’s storage products can assist in earning points towards the various LEED rating system certification levels. In some cases, Montel’s high-density mobile storage systems contribute directly to individual LEED points, but in other cases can only help meet the overall intent.

<b>LEED® SUMMARY TABLE</b>					<b>MONTEL PRODUCT POTENTIAL CONTRIBUTION</b>
<b>CATEGORY</b>		<b>PREREQUISITES</b>	<b>CREDITS</b>	<b>POINTS</b>	<b>LEED®</b>
<b>SS</b>	Sustainable Sites	1	8	26	<b>0 points</b>
<b>WE</b>	Water Efficiency	1	3	10	<b>0 points</b>
<b>EA</b>	Energy and Atmosphere	3	6	35	<b>0 points</b>
<b>MR</b>	Materials and Resources	1	8	14	<b>6 points</b>
<b>IEQ</b>	Indoor Environmental Quality	2	8	15	<b>3 points</b>
<b>ID</b>	Innovation in Design	0	2	6	<b>3 points</b>
<b>RP</b>	Regional Priority	0	1	4	<b>4 points</b>
<b>TOTAL</b>		<b>8</b>	<b>36</b>	<b>110</b>	<b>Up to 16 possible points</b>

# CUSTOM-BUILT FOR YOUR INDUSTRY

## ENGINEERED HIGH-DENSITY STORAGE SYSTEMS

We have developed a comprehensive line-up of best-in-class high-density storage solutions that are precision-engineered to deliver lasting high-capacity storage. Their versatility makes them the movable and powered storage of choice for any industry: aerospace, automotive, defense, distribution centers, food, beverages, manufacturing and pharmaceutical plants, third-party logistics, etc.







## AGRICULTURE

Maximize storage capacity with minimal wattage of power us. It is all about your grams per watt. Cultivate and optimize your agriculture's racking & shelving storage needs with Montel's multi-functional, high-density shelving solutions.



## ALCOHOL & BEVERAGES

So that your stocks management of alcohol, liquors and beverages flows abundantly, Montel industrial storage proposes a series of solutions adapted to your storage demands.



## AUTOMOTIVE

Montel's industrial storage products which are customized for the automotive industry will allow you to maximize your space while increasing your storage capacity.



## MANUFACTURING PLANTS

Establish a customized storage solution in your production plant with Montel's industrial storage solutions.



## PHARMACEUTICAL

Prescribe Montel's industrial storage solutions to meet your pharmaceutical products plant's requirements in terms of storage.



## DISTRIBUTION CENTERS

An efficient distribution center! That is what Montel industrial storage proposes with its space saving solutions adapted for your industry.



## FOOD PLANTS

The perfect recipe for your food plant: Montel's industrial storage systems.



## 3RD-PARTY LOGISTICS

Make storage a dependable link in the supply chain for your third-party logistics provider with Montel's durable, high-density industrial racking and shelving systems.



## AEROSPACE

Get more space with Montel's industrial storage shelving and storage systems specially designed for the aerospace industry.



## MILITARY & DEFENSE

Security! The only word that will come to mind with Montel's industrial storage systems intended for the defense and military sectors.

# COLD STORAGE



## BEAT THE HEAT WITH MOBILE RACKING SOLUTIONS FOR COLD STORAGE

Cold storage is nothing to shake a popsicle at. Keeping an entire inventory at a consistent temperature is an energy – and resource – intensive endeavor, but businesses that can successfully manage or even overcome these obstacles avoid financial freezer burn.

There’s always room to grow, even in the smallest storage facilities. Powered mobile racking for industrial cold storage environments takes into consideration every aspect that goes into effective temperature controlled settings, preventing operations – as well as stored materials – from thawing out.



MOBILE STORAGE SYSTEM	SMARTSPACE 2M, 2MA	SMARTSPACE 2P	MOBILEX®	SAFEAISLE®	RACK&ROLL 16MA	RACK&ROLL 16P	SAFERAK® 32P, 60P
<b>Mode of Operation</b>	Manual or Mechanical-Assist	Powered	Mechanical-Assist	Powered	Mechanical-Assist	Powered	Powered
<b>Optional Rail</b>	Galvanized (Standard)	Galvanized (Standard)	Stainless Steel (Optional)	Stainless Steel (Optional)	Shock Resistant Powder Paint (Standard) or Stainless Steel (Optional)	Shock Resistant Powder Paint (Standard) or Stainless Steel (Optional)	Shock Resistant Powder Paint (Standard) or Stainless Steel (Optional)
<b>Temperature Criteria</b>							
Above 32°F (0°C)	Yes	Yes	Yes	Yes	Yes	Yes	Yes
Below 32°F (0°C) to 14°F (-10°C)	Yes	No	Yes	No	Yes	No	Yes
Below 14°F (-10°C) to -4°F (-20°C)	Yes	No	Yes	No	Yes	No	No



## MEAT

Montel's cold storage solutions are built to adapt to all meat products.



## DAIRY PRODUCTS

Dairy products storage is always a challenge since stock rolling management requires fast access and an accurate way to document product locations. Montel's cold storage solutions offer state-of-the-art inventory management features.



## FROZEN

Montel's cold storage solutions are built to adapt to all frozen products and storage conditions.



## FROZEN FRUITS, JUICES & VEGETABLES

Preserve the flavor of fruits & vegetables and optimize your storage space with Montel's cold storage solutions.



## FOOD SPECIALITIES

Get more control and flexibility on your storage setup with Montel's cold storage solutions.



## GRAIN MILL PRODUCTS

Since grain mill product storage require flexibility and strong structures, Montel offers a wide range of specialized solutions for cold storage.



## BAKERY PRODUCTS

Most food can't sit around in a warehouse for months on end. On the contrary, as new items are produced, they must vacate the plant as soon as possible to ensure freshness. Montel's cold storage solutions offer multiple configuration options for bakery products.



## SUGAR AND CONFECTIONERY PRODUCTS

Leave room for dessert. Unlike other warehouses, food plants devote a significant portion of its floor space to production. Montel's cold storage solutions offer a 50-percent reduction of inventory space, in other words it doubles your storage space.



## BEVERAGES

Montel's cold storage solutions are built to maximize and optimize storage space for beverage storage.

# STORAGE SOLUTIONS

## GROW FROM THE INSIDE, OPTIMIZE AND GET RESULTS

Growing industries often face the need to expand their warehouse shelving surface for greater industrial storage space. The acquisition of a new warehouse or the expansion of an existing one are often evaluated. With Montel mobile storage solutions, discover new floor space so you may not have to expand, relocate or lease additional space since you could grow from the inside of your existing four walls.

Montel understands the importance of offering cost-effective innovative storage solutions. For your unique storage needs, our mobile storage systems offer the performance solution required for greater evolving storage capacity in less floor space.





## MOBILE STORAGE SYSTEMS

Recover up to 50% of your floor space or double your storage capacity with the Quadral, SmartSpace, Mobilex®, SafeAisle®, RACK&ROLL and SAFERAK® storage systems.



## SHELVING SYSTEMS

Montel's shelving storage systems are the most versatile in the industry since the shelves, drawers, and accessories are interchangeable between each product line.



## INDUSTRIAL MODULAR DRAWERS

Industrial drawers designed for Montel industrial systems. 400 lb load capacity industrial-grade drawers and 200 lb load capacity commercial-grade drawers available.



## CABINETS

Montel offers a complete range of storage cabinets for all types of material. The system includes accessories for various possible configurations, sure to satisfy your most particular needs.



## WORKBENCHES

The workbenches offered by Montel permit total flexibility to perform a wide array of tasks. Drawers, cabinets, adjustable shelves, steel bins, storage containers, rear perforated panels can be combined to offer an optimum working environment.



## HANGING STORAGE SCREENS

Screens storage systems optimize your storage space while using minimal footprint. These space-efficient pull-out racks and mobile racks increase the productivity of any warehouse or factory environment.

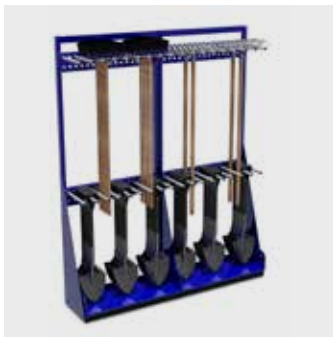

## HANGING STORAGE PANELS

Montel industrial hanging panels offer a flexible and reliable way to store long tools and parts.



## STORAGE SOLUTIONS

# MOBILE STORAGE SYSTEMS

RECOVER HALF OF YOUR VALUABLE FLOOR AND VOLUME SPACE OR DOUBLE YOUR STORAGE CAPACITY WITH MONTEL'S MOBILE STORAGE SYSTEMS. THE USE OF AVAILABLE SPACE, WHETHER TO INCREASE STORAGE CAPACITY, FREE UP VALUABLE ROOM FOR PRODUCTION OR OTHER USES, OR GET RID OF SPACE YOU DO NOT NEED TO PAY FOR.



**CREATE MORE ROOM. NO NEED TO EXPAND. NO NEED TO RELOCATE. NO NEED TO LEASE ADDITIONAL SPACE.**

Discover new floor space by simply adding your existing industrial racking on top of the heavy duty industrial mobile carriages and rails.

### **IMMEDIATE PAYBACK**

The mobile storage system generates a rapid return on your investment. In addition to making better use of your existing space, you can lower your production costs by improving the organization of your materials, either raw, work-in-process, or finished products.

**FREE UP VALUABLE SPACE  
STREAMLINE YOUR WORKFLOW  
LOWER YOUR PRODUCTION COSTS**

## **MOBILE STORAGE SYSTEMS**



### **QUADRAL MODULAR SLIDING LATERAL STORAGE**

Quadral is a compact, high-density movable shelving system that leverages your available space to make your industrial storage as efficient as possible.



### **SMARTSPACE 2M, 2MA, 2P, MANUAL, MECHANICAL-ASSIST, POWERED**

The SmartSpace is operated either manually by hand, mechanically operated with the 3-spoke mechanical-assist SafeCrank, or electrically-powered with a simple push on a touchpad control.



### **MOBILEX® MECHANICAL-ASSIST STORAGE SYSTEM**

Optimize and customize your storage space with Montel's flexible high-density movable shelving system. Choose the best optional mechanical safety brake in the industry (Patent # 7,645,000). The load capacity is 1,000 lb (454 kg) per linear foot.



### **SAFEAISLE® POWERED MOBILE STORAGE SYSTEM**

Prioritize safety and productivity while boosting your storage capacity with Montel's high-density powered mobile systems featuring the patented LED Guard™. The load capacity is 1,000 lb (454 kg) per linear foot.



### **RACK&ROLL 16MA, 16P MOBILE STORAGE SYSTEMS**

Maximize the efficiency and minimize the costs of your warehouse storage space with Montel's mechanical-assist and powered mobile storage systems designed for industrial environments. The load capacity is 16,000 lb (7,258 kg) per double rack sections.



### **SAFERAK® 32P INDUSTRIAL POWERED MOBILE RACKING**

Maximize the efficiency and minimize the costs of your warehouse storage space with Montel's powered mobile racking designed for industrial environments. The load capacity of the SAFERAK® 32P is 32,000 lb (14,514 kg) per double rack sections.



### **SAFERAK® 60P INDUSTRIAL POWERED MOBILE RACKING**

Maximize the efficiency and minimize the costs of your warehouse storage space with Montel's powered mobile racking designed for industrial environments. The load capacity of the SAFERAK® 60P is 60,000 lb (27,215 kg) per double rack sections.

**STORAGE SOLUTIONS**

# **SHELVING SYSTEMS**

**MONTEL SHELVING SYSTEMS OFFER A WIDE RANGE OF ACCESSORIES AND PRACTICAL FEATURES WHICH CAN BE ADAPTED TO YOUR SPECIFIC STORAGE NEEDS.**





Montel's shelving storage systems are the most versatile in the industry since the shelves, drawers, and accessories are interchangeable between each product line. Furthermore, the shelves are designed to be configured and reconfigured easily and efficiently without any tools. The shelving systems are designed to offer more storage per shelf and drawer. Please inquire about the many unique features and benefits of Montel shelving systems.



### **SMARTSHELF® 4-POST HYBRID SHELVING**

Make your shelving a perfect fit for a broad array of items with Montel's one-shelf-fits-all four-post patented hybrid system (Patent # 6,814,245).

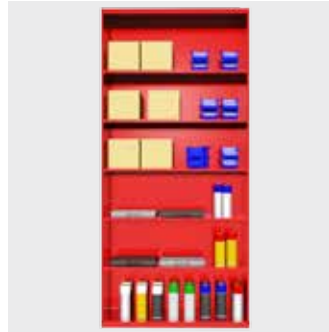

### **CABINET STYLE CASE-TYPE SHELVING**

Refine filing and cabinet storage in your office, business or medical practice with Montel's case-type shelving compatible with mobile storage systems.



### **4D-500, 4D-1000, 4D-1500 WIDE SPAN RACKING**

Improve heavy-duty storage of irregular industrial items with Montel's long-span, four-post shelving system. The load capacity is either 500 lb (227 kg), 1,000 lb (454 kg), 1,500 lb (680 kg) per tier or 6,000 lb (2,722 kg) per bay.



### **HIGH-BAY WAREHOUSE SHELVING**

Use warehouses storage with HI-BAY high-density storage solutions and use on-site space for more valuable and profitable functions. The load capacity is 800 lb (363 kg) per shelf.



## STORAGE SOLUTIONS

# SHELVING

# WITH DRAWERS

WORKS WITH  
SmartShelf®

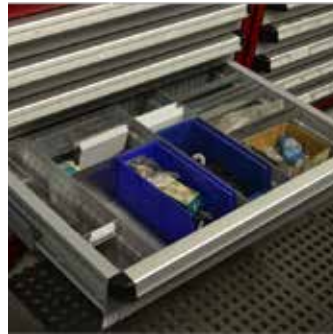
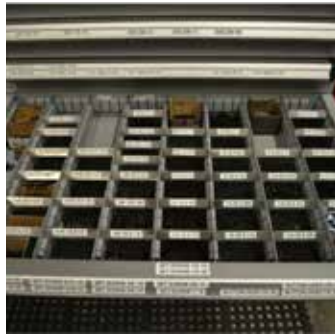
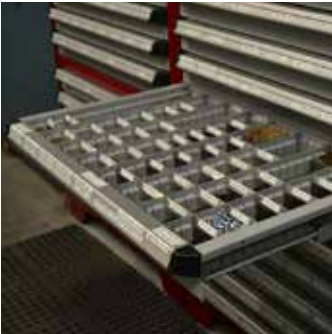

## 36 SIZES AVAILABLE

WIDTH	NOMINAL	USABLE SPACE	DEPTH	NOMINAL	USABLE SPACE	HEIGHT	NOMINAL	USABLE SPACE
	36"	32"		18"	15"		4"	3"
42"	38"	24"	21"	5"	4"			
48"	44"	30"	27"	6"	5"			
				8"	7"			

**INDUSTRIAL MODULAR DRAWERS DESIGNED FOR SMARTSHELF® 4-POST HYBRID SHELVING**

**MODULAR DRAWERS LOAD CAPACITY:**

200 lb load capacity commercial-grade drawers

400 lb load capacity industrial-grade drawers

**CONSIDERATIONS**

Drawer handles overhang by about 2 inches.  
Consider wider bumpers when on mobile carriages.

Minimum of 2 anti-tip rails if used on mobile carriages

Maximum height for drawers-in-shelving: 48 inches

Static units anchored to floor

**LOCK-IN MECHANISM WITH HANDLE**

The ergonomic aluminium handle and lock-in device procure a user-friendly experience in a sturdy unit.

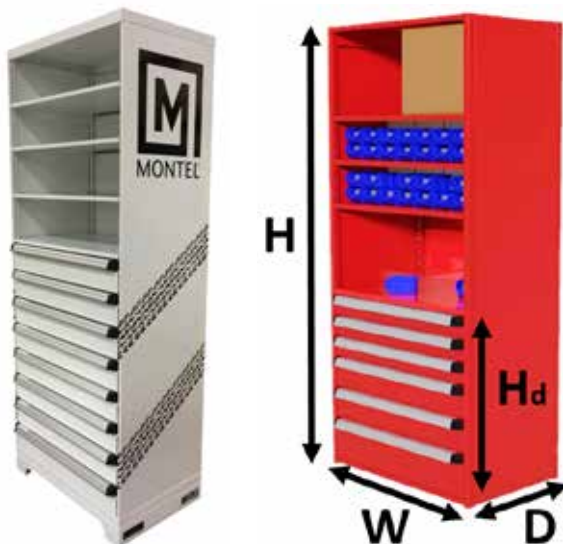

\*SmartShelf 4-Post shelving shown with industrial drawers and a transpallet base.

**3 TO 8 COMPARTMENTS**

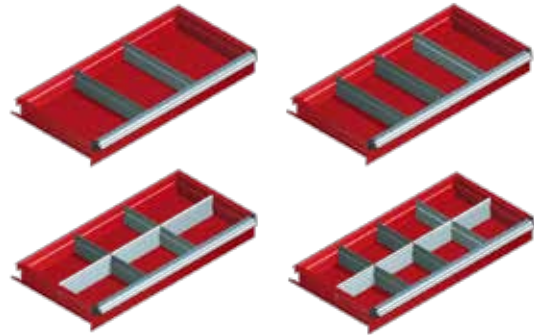

**12 TO 24 COMPARTMENTS**

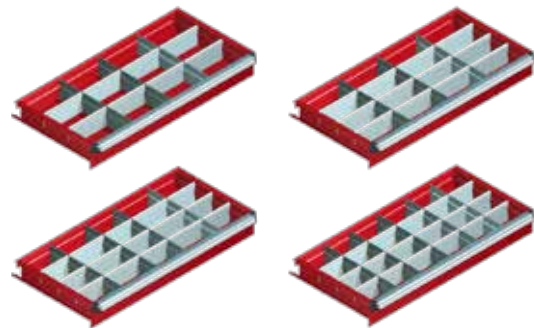

**32 TO 44 COMPARTMENTS**



**SMARTSHELF® 4-POST HYBRID SHELVING WITH DRAWERS**

<b>WIDTH (W)</b>	<b>36"</b>	<b>42"</b>	<b>48"</b>
<b>DEPTH (D)</b>	<b>18"</b>	<b>24"</b>	<b>30"</b>
<b>OVERALL HEIGHT* (H)</b>	<b>75"</b>	<b>87"</b>	
<b>BANK OF DRAWERS HEIGHT (Hd)</b>	<b>24"</b>	<b>36"</b>	<b>48"</b>

\* Other height dimensions available upon request.

**STORAGE SOLUTIONS**

# CABINETS

**MONTEL OFFERS A COMPLETE RANGE OF STORAGE CABINETS FOR ALL TYPES OF MATERIALS.**



Montel offers a complete range of storage cabinets for all types of materials. The system includes accessories for various possible configurations, sure to satisfy your most particular needs.

The inner compartments and dividers of each modular drawer are customizable so your gear is organized to maximize your storage space.

### LIGHT DUTY & HEAVY DUTY STORAGE CABINETS - HINGED DOORS\*

<b>WIDTHS (W)</b>	<b>24"</b>	<b>30"</b>	<b>36"</b>	<b>39 3/8"</b>	<b>42"</b>		
<b>DEPTHS (D)</b>	<b>10"</b>	<b>12"</b>	<b>13"</b>	<b>15"</b>	<b>16"</b>	<b>18"</b>	
<b>HEIGHTS* (Hd)</b>	<b>34 1/2"</b>	<b>43 1/2"</b>	<b>45"</b>	<b>57"</b>	<b>78"</b>	<b>87"</b>	<b>90"</b>

### DRAWER CABINETS & MOBILE DRAWER CABINETS\*

<b>WIDTHS (W)</b>	<b>30"</b>	<b>36"</b>	<b>42"</b>	<b>48"</b>
<b>DEPTHS (D)</b>	<b>18"</b>	<b>24"</b>	<b>30"</b>	
<b>BANK OF DRAWERS HEIGHT* (Hd)</b>	<b>26"</b>	<b>48"</b>		

#### COUNTERTOP OPTIONS

- Steel
- Stainless Steel
- Wood

#### DRAWER CONFIGURATIONS FOR LIGHT-DUTY DRAWER CABINETS

- 5 po (13 cm)
- 6 po (15 cm)
- 10 po (25 cm)



\* Add 7" in height for casters or add 4" in height for a transpallet base for heavy duty storage cabinets. Overall height of cabinet may slightly vary if provided with or without a countertop and depending on countertop material and thickness.



### LIGHT-DUTY STORAGE CABINETS - HINGED DOORS

Montel light storage cabinets are built to provide the most flexible storage solution.



### HEAVY-DUTY STORAGE CABINETS - HINGED SINGLE DOOR

Montel highly resistant single door storage cabinets are perfect to secure and store your industrial components.



### HEAVY-DUTY STORAGE CABINETS - HINGED DOUBLE DOORS

Montel highly resistant double door storage cabinets are perfect to secure and store your industrial components.



### LIGHT-DUTY DRAWER CABINETS

Montel light-duty drawer cabinets can accommodate 100 lb or 200 lb load capacity commercial-grade drawers.



### HEAVY-DUTY DRAWER CABINETS

Montel heavy-duty drawer cabinets are the ideal solution to store your equipment. Heavy-duty drawer cabinets can accommodate 400 lb load capacity industrial-grade drawers.



### HEAVY-DUTY MOBILE DRAWER CABINETS

Montel heavy-duty mobile drawer cabinets store your equipment while keeping a mobile option to easily move it anywhere you want.

## STORAGE SOLUTIONS

# WORKBENCHES

**THE WORKBENCHES OFFERED BY MONTEL INDUSTRIAL ALLOW FOR FLEXIBILITY AND ADAPTATION IN ORDER TO PERFORM A WIDE ARRAY OF TASKS.**

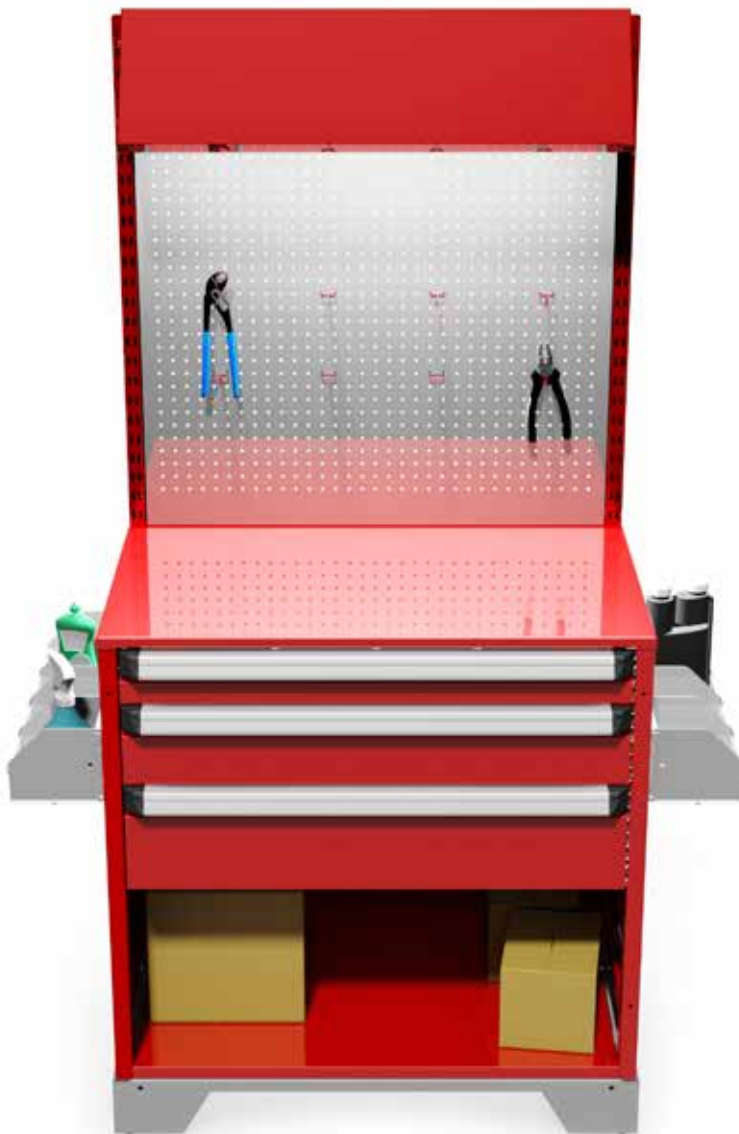

The workbenches offered by Montel permit total flexibility to perform a wide array of tasks. The complimentary Montel products such as drawers, cabinets, adjustable shelves, steel bins, storage containers, rear perforated panels can be combined to offer the optimum working environment while increasing productivity.

### **REAR PANELS**

Montel perforated rear panels can be installed on top of workbenches to hang tool holders, hooks, and storage containers. They keyhole hooks keep your workbenches organized.

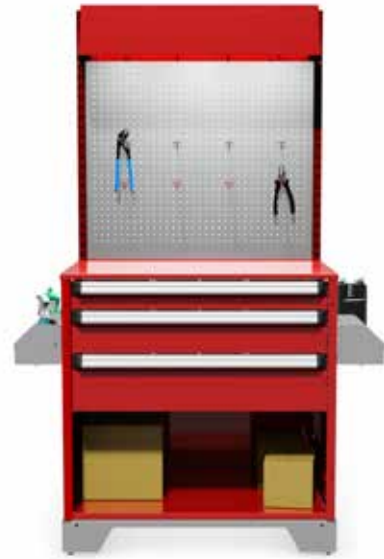

### **ADJUSTABLE SHELVES, DIVIDERS, AND BINS**

Adjustable shelves, dividers, steel bins, and storage containers can be hung under, above or on either side of the workbenches.

### **PRE-DRILLED WORKBENCH TOP**

The workbenches are pre-drilled with pilot holes to accommodate a large variety of tops or simply choose the hard laminate tops offered by Montel if you do not want the standard steel tops.

### **LIGHTING**

Overhead fluorescent tubes light directly downward your working area.

### **POWER SUPPLY**

Power supplies can be attached to the support pillars of the rear perforated panels without the need of any tools.



### **DRAWER CABINETS & MOBILE DRAWER CABINETS**

The Montel drawer cabinets nicely complement your functional workbench, and add mobility with casters.



## STORAGE SOLUTIONS

# HANGING STORAGE SCREENS

**SCREENS STORAGE SYSTEMS OPTIMIZE YOUR STORAGE SPACE WHILE USING MINIMAL FOOTPRINT. THESE SPACE-EFFICIENT MOBILE RACKS INCREASE THE PRODUCTIVITY OF ANY WAREHOUSE OR FACTORY ENVIRONMENT.**





**SCREENS STORAGE SYSTEMS OPTIMIZE YOUR STORAGE SPACE WHILE USING MINIMAL FOOTPRINT. THESE SPACE-EFFICIENT MOBILE STORAGE SYSTEMS INCREASE THE PRODUCTIVITY OF ANY WAREHOUSE OR FACTORY ENVIRONMENT.**

Vertical pull-outs and mobile mesh screens or perforated steel panels orderly store and manage your items. Space-efficient storage units are therefore perfectly equipped to handle your items for which suspended storage is preferable, such as tools or supplies.

Storage screens or panels effectively leverage your available storage square footage by using vertical double-sided screens or panels mounted on a rolling carriage. The items can be easily accessed from either side. The mobile screens or panels storage units can accommodate many objects of varying sizes and weights within a relatively compact area, allowing you to maximize the use of your available space.



**PULL-OUT HANGING STORAGE SYSTEMS**

With a modular, expandable and double-mesh design, Montel's pull-out screens are the most flexible industrial panel storage solutions in the industry.



**MOBILE HANGING STORAGE SCREEN SYSTEMS**

Move your items effortlessly with Montel's mobile hanging screen systems. With a doublemesh design, Montel's mobile screens are the most reliable screen storage solutions.

**STORAGE SOLUTIONS**

# HANGING STORAGE PANELS

**MONTEL INDUSTRIAL HANGING PANELS OFFER A FLEXIBLE  
AND RELIABLE WAY TO STORE LONG TOOLS AND PARTS.**

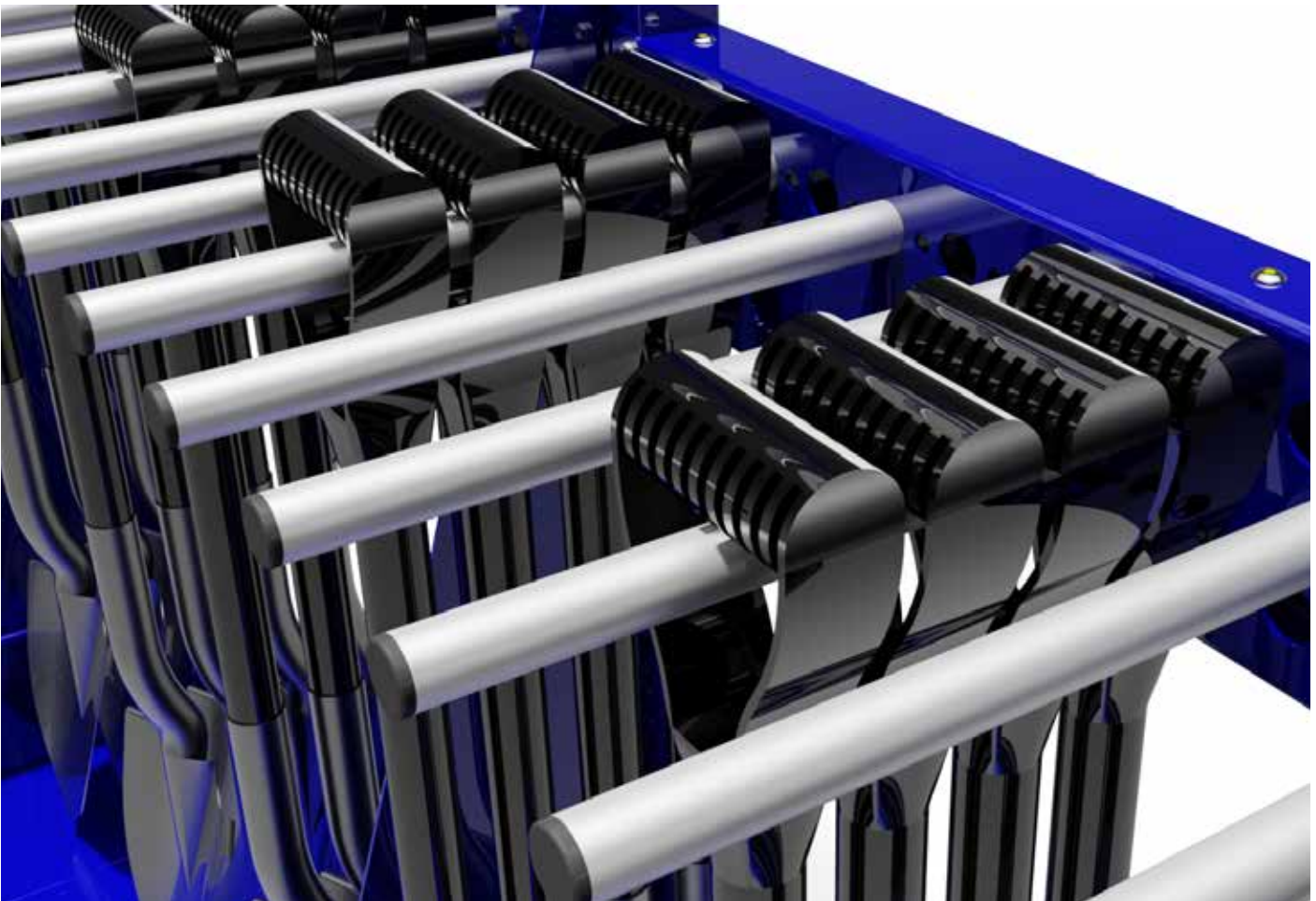

**OPTIMIZE YOUR STORAGE SPACE FOR LONG AND UNUSUAL DIMENSION ITEMS WITH MONTEL'S HANGING PANELS. PERFORATED UNIVERSAL CROSSBARS OFFER UNLIMITED CONFIGURATION POSSIBILITIES.**

The various mounting positions of the crossbars and rods make this cantilever shelving unit a perfect storage solution to hang any long items.

**HANGING PANELS CAN BE ADAPTED TO ALMOST ALL ITEMS AND DIMENSIONS LIKE:**

- Tools
- Cables
- Wiring and straps
- Tubes and pipes
- Shovels and scratchers
- Brooms and other cleaning tools
- And much more...



## SAFETY

# MANUAL MOBILE STORAGE SYSTEMS SMARTSPACE 2M

### OPTIONAL SAFETY

#### FOOT LATCH SAFETY

Montel's foot-latch safety for manual SmartSpace mobile storage systems is the ideal option to prevent the mobile storage system from moving. Engaging the foot-latch safety before entering an aisle prevents other users from operating a system already in use.

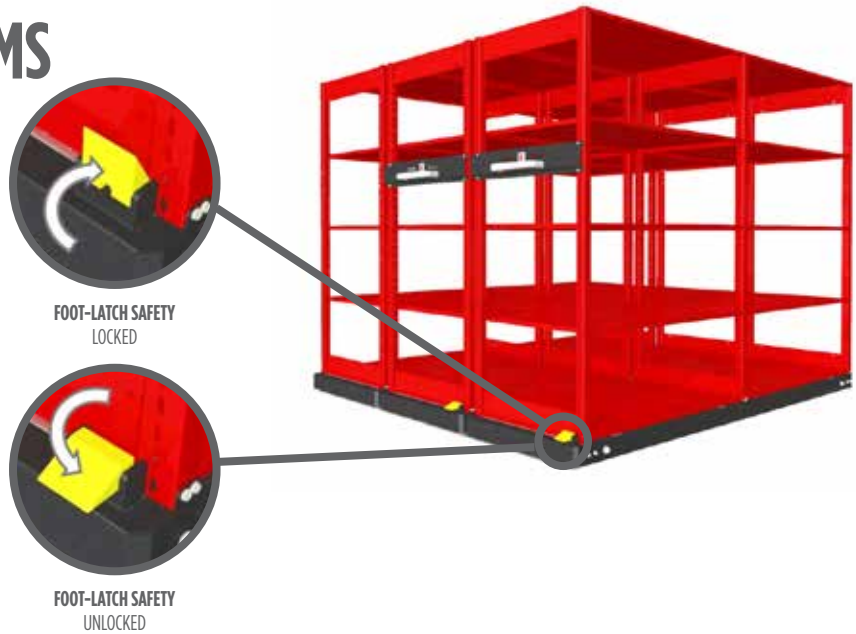

## SAFETIES

# MECHANICAL-ASSIST MOBILE STORAGE SYSTEMS

## SMARTSPACE 2MA | MOBILEX® | RACK&ROLL 16MA



### STANDARD SAFETY

#### SAFECRANK AISLE SAFETY PUSH-BUTTON



UNLOCKED



PUSH TO LOCK OR UNLOCK



LOCKED

To operate the system, rotate the SafeCrank handle clockwise or counterclockwise. To lock or unlock the SafeCrank handle, simply press the aisle safety push-button located at the center of the handle. A locked handle prevents the corresponding mobile unit from moving. Mobile units on both sides of an aisle in use must be locked to ensure user safety.

### OPTIONAL SAFETY | MOBILEX®

#### GRAVITY-FED MECHANICAL SAFETY BRAKE



(US PATENT # 7,645,000 / CANADA PATENT # 2,545,090)

Montel's patented mechanical safety brake ensures complete protection for users and objects. The toe-level bar, when pressed, will automatically stop the carriage. Only a light pressure is needed for the bar to activate the mechanism.

# SAFETIES

# POWERED MOBILE STORAGE SYSTEMS

## SMARTSPACE 2P | SAFEAISLE® | RACK&ROLL 16P



RACK&ROLL 16P SHOWN  
WITH PATENTED Aisle LED Guard™  
COMPLETE AISLE-DETECTION PASSIVE SAFETY

### STANDARD SAFETIES

#### AISLE-ENTRY PEOPLE COUNTER

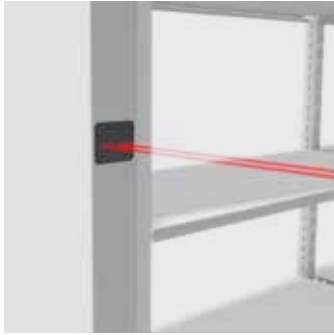

Carriage movement instantly stop when the system detects any beam disruption in front of the storage system when a user is entering an aisle.

#### INFRARED FOOT-LEVEL SAFETY BEAM ONE SIDE OF MOBILE CARRIAGE

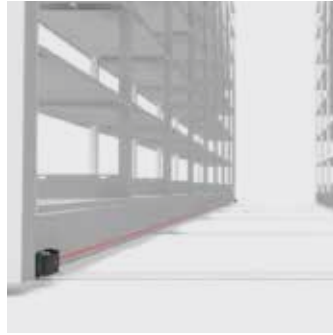

Photoelectric beam projecting on one side of each aisle is mounted low on the carriage side member.

**NOTE:** SUITABLE ONLY FOR VERY LOW TRAFFIC RESTRICTED AREAS, AND SHORT MOBILE CARRIAGES BUT NOT RECOMMENDED FOR PUBLIC ACCESS SPACES.

### OPTIONAL SAFETIES

#### INFRARED FOOT-LEVEL SAFETY BEAMS BOTH SIDES OF MOBILE CARRIAGE

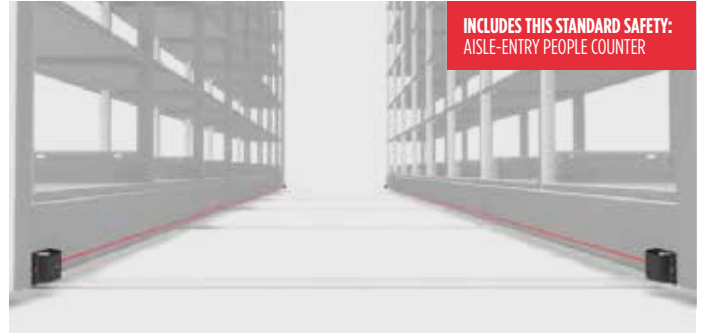

Photoelectric beams projecting on both sides of each aisle are mounted low on the carriage side members.

**NOTE:** SUITABLE ONLY FOR LOW TO MEDIUM TRAFFIC RESTRICTED AREAS BUT NOT RECOMMENDED FOR PUBLIC ACCESS SPACES.

### ADVANCED OPTIONAL SAFETY

#### AISLE LED GUARD™ COMPLETE AISLE-DETECTION PASSIVE SAFETY



**NOTE 1:** AISLE LED GUARD™ IS REQUIRED FOR PUBLIC ACCESS AREAS.

**NOTE 2:** FLOOR LEVEL-SAFETY BEAM(S) ARE NOT REQUIRED WITH AISLE LED GUARD™.

AISLE LED GUARD™ IS PATENTED.

#### MONTEL REVOLUTIONIZES MOBILE STORAGE WITH AISLE LED GUARD™ FOR SMARTSPACE 2P, SAFEAISLE® AND RACK&ROLL 16P

Montel's powered mobile systems supplied with the advanced optional safety Aisle LED GUARD™ passive safety adds a new dimension by continuously detecting the whole floor surface footprint of an aisle.

LED sensors detect people and objects in open aisles. While aisles are in use or occupied, racking modules are locked in place, thereby protecting users from injury and stored materials from damage. Regardless of what you and your organizations stores Aisle LED Guard™ ensures no avoidable harm comes to any of it should it fall from your shelves.

#### COMPLETELY PASSIVE

Aisle LED Guard™ is 100% passive. Users do not have to remember to locate and activate any safety devices when interacting with the mobile shelving or racking system. Even with fully loaded racking, Aisle LED Guard™ will protect users and objects left in the aisle without human intervention.

#### FULL COVERAGE

Where users stand in an open aisle will not impact the effectiveness of Aisle LED Guard™. No matter where a user are located in the aisle, no matter where in the aisle a product falls, no matter if a pallet is left in the aisle, the units will not close without complete clearance.

#### FOOLPROOF DESIGN

Aisle LED Guard™ used in Montel products cannot be deactivated, overwritten or bypassed. No sequence of button mashing or reconfiguration will shut it down. Aisle LED Guard™ places mobile shelving installations in a constant state of vigilance.

#### IMPROVE PRODUCTIVITY

SmartSpace 2P, SafeAisle and RACK&ROLL 16P systems provided with Aisle LED Guard™ automatically reset as soon as a user or object is cleared from an aisle. Users waste no time manually resetting an aisle after each use.

# SAFETIES

## POWERED MOBILE STORAGE SYSTEMS SAFERAK® 32P | SAFERAK® 60P



### RATED MACHINE SAFETY STANDARDS

IN ORDER TO BE COMPLIANT WITH “RATED MACHINE SAFETY STANDARDS”, MONTEL HIRED AN OUTSIDE FIRM SPECIALIZED IN ANALYZING SAFETY IN INDUSTRIAL ENVIRONMENTS. FOLLOWING THIS ANALYSIS, MONTEL DECIDED TO COMPLY BY OFFERING NUMEROUS STANDARD SAFETIES.



#### SYSTEM ENTRY INFRARED BEAM CURTAIN



Carriage movement instantly stop when the system detects any beam disruption in front of the storage system.

#### INFRARED FLOOR-LEVEL SAFETY BEAMS BOTH SIDES OF EACH MOBILE CARRIAGE



Photoelectric beams projecting on both sides of each aisle are mounted low on the carriage side members.

#### READILY ACCESSIBLE EMERGENCY STOP BUTTON



Face panels emergency stop buttons are arguably the most identifiable element on a SAFERAK®.

#### SAFEGUARDS FOR ALL MECHANICAL MOVING PARTS



All mechanical moving components are concealed and protected by a steel safety guard to prevent inadvertent access.

#### MECHANICAL RATCHET BACKUP OVERRIDE



The mechanical ratchet ensures complete accessibility even in the event of a power failure (no operational downtime).

#### STROBE LIGHT AND BUZZER



A safety alert buzzer, a visual signal and flashing notifications are provided prior to and during carriage movement.

### OPTIONAL SAFETIES

**IN-AISLE EMERGENCY STOPS**  
ALTERNATING AND OFFSET ON EACH SIDE OF AN AISLE. EN95 4-1 CATEGORY 1 COMPLIANT

**INDUSTRIAL PLC ON EVERY MOBILE**

**LADDER SECURITY**

**KEYSWITCH**

**SECURITY PERIMETER**  
ISO 13857 COMPLIANT

# AISLE LED GUARD™ ADVANCED OPTIONAL SAFETY

## POWERED MOBILE STORAGE SYSTEMS SAFERAK® 32P | SAFERAK® 60P

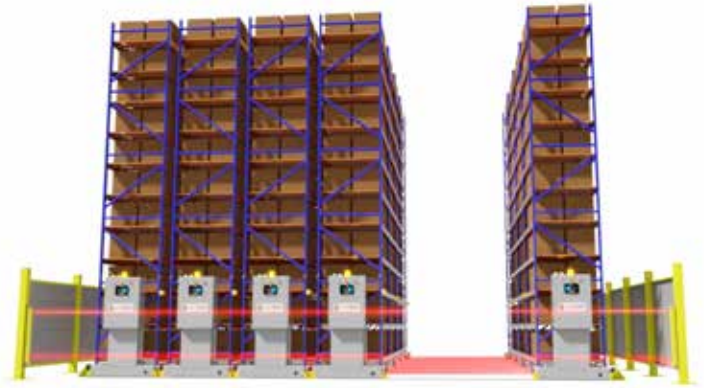

### ADVANCED OPTIONAL SAFETY

#### AISLE LED GUARD™

COMPLETE AISLE-DETECTION PASSIVE SAFETY



NOTE: RECOMMENDED FOR PUBLIC ACCESS OR HIGH TRAFFIC AREAS.

AISLE LED GUARD™ IS PATENTED.

#### MONTEL REVOLUTIONIZES MOBILE STORAGE WITH AISLE LED GUARD™ FOR SAFERAK® 32P AND SAFERAK® 60P

Montel's powered mobile systems supplied with the advanced optional safety Aisle LED Guard™ passive safety adds a new dimension by continuously detecting the whole floor surface footprint of an aisle.

#### THE WORLD OF HIGH-DENSITY STORAGE WILL NEVER BE THE SAME

Aisle LED Guard™ represents a major watershed moment in employee safety and shrinkage prevention for industrial storage used in day-to-day operations.

With nearly a century of mobile storage experience under its belt, Montel developed Aisle LED Guard™ to keep industries everywhere perpetually productive, cost-effective and employee-friendly. So, how does Montel's patented Aisle LED Guard™ work and why do those features matter to modern businesses?

#### AISLE LED GUARD™ IN A NUTSHELL

Mobile shelving and racking reduces storage footprints thanks to its collapsible architecture. However, in industries like manufacturing and logistics where processes move at lightning speed, thoughtlessly closing a mobile storage unit could pose a risk to both goods and workers.

LED sensors detect people and objects in open aisles. While aisles are in use or occupied, racking modules are locked in place, thereby protecting users from injury and stored materials from damage. Regardless of what you and your organizations stores Aisle LED Guard™ ensures no avoidable harm comes to any of it should it fall from your racking.

#### SEEMS PRETTY STRAIGHTFORWARD, RIGHT? LET'S DIG A BIT DEEPER INTO AISLE LED GUARD™ TO FULLY UNDERSTAND HOW MONTEL DESIGNED THE PERFECT SAFETY PRECAUTION:

##### COMPLETELY PASSIVE

Aisle LED Guard™ is 100% passive. Users do not have to remember to locate and activate any safety devices when interacting with the mobile shelving or racking system. Even with fully loaded racking, Aisle LED Guard™ will protect users and objects left in the aisle without human intervention.

##### FULL COVERAGE

Where users stand in an open aisle will not impact the effectiveness of Aisle LED Guard™. When Montel customers invest in powered mobile shelving or racking systems supported by Aisle LED Guard™, they're putting their money into complete aisle coverage for consummate protection. No matter where a user are located in the aisle, no matter where in the aisle a product falls, no matter if a pallet is left in the aisle, the units will not close without complete clearance. With full coverage from LED sensors, Aisle LED Guard™ protects users and objects every step of the way.

##### FOOLPROOF DESIGN

Aisle LED Guard™ used in Montel products cannot be deactivated, overwritten or bypassed. No sequence of button mashing or reconfiguration will shut it down. Aisle LED Guard™ places mobile shelving installations in a constant state of vigilance.

##### IMPROVE PRODUCTIVITY

Operators can easily reset SAFERAK® remotely with the industrial rugged Wi-Fi remote control. Users won't have to step out of their forklifts to reset the system.

PRODUCTIVITY & TECHNOLOGY

# ePulse™ REMOTE MONITORING SOFTWARE



INCREASE PRODUCTIVITY  
WIRELESSLY

PAIRS WITH  
SMARTSPACE 2P  
SAFEAISLE®  
RACK&ROLL 16P  
SAFERAK® 32P  
SAFERAK® 60P







## INCREASE PRODUCTIVITY WIRELESSLY

Created to provide additional certainty and safety monitoring once Montel's high-density powered mobile storage systems are installed, Montel now offers ePulse™. This remote monitoring & configuration software has the functionality of providing the capability to manage settings remotely and monitor your high-density powered mobile system's performance and operations with assurance. If remote network connectivity access to Montel is granted, certified technicians could monitor and configure your system remotely from their own location.

For maximum reliability and peace of mind, ePulse™ proactively identifies any potential issues with your system, provides quick diagnostics of the system to maximize your uptime, sends automatic email notifications of system errors. You could even decide to monitor and configure your own Montel powered mobile system 24 hours a day, every day of the year.

To increase productivity & efficiency, ePulse™ allows to collect aisle entry data for any preset period of time from your Montel powered mobile system. Once this data is analyzed for each aisle, ePulse™ permits to reconfigure your powered mobile system to your preferred settings and parameters including:

- Priority Aisle
- Auto-Closing/Security Park
- Auto-Spacing/Ventilation Park
- Auto-Cycling
- Programmable Speeds (start-up/cruising/braking)
- Sequential Move, Block Move

For additional security, with the collected & analyzed aisle entry data from your powered mobile system, ePulse™ allows to reconfigure the security settings of your system at anytime. Whether it be adjusting the programmable speeds, or remotely configuring your system to close all aisles and lock at a specific time after business hours, or open and unlock before business hours, ePulse™ offers security with peace of mind.

Montel powered systems can be operated remotely from the fingertips on your computer with the ePulse™. The TCP/IP protocol facilitates the network connectivity from a computer to the Montel powered system. This provides reliable high-speed communication, and permits remote reconfiguring of your system using the ePulse™ remote monitoring & configuration software.

Montel's ePulse™ remote monitoring & configuration software is available with SmartSpace 2P, SafeAisle®, RACK&ROLL 16P, SAFERAK® 32P, SAFERAK® 60P.



PRODUCTIVITY & TECHNOLOGY

# ePulse™ REMOTE MONITORING PACKAGES

**PAIRS WITH**  
 SMARTSPACE 2P  
 SAFEAISLE®  
 RACK&ROLL 16P  
 SAFERAK® 32P  
 SAFERAK® 60P

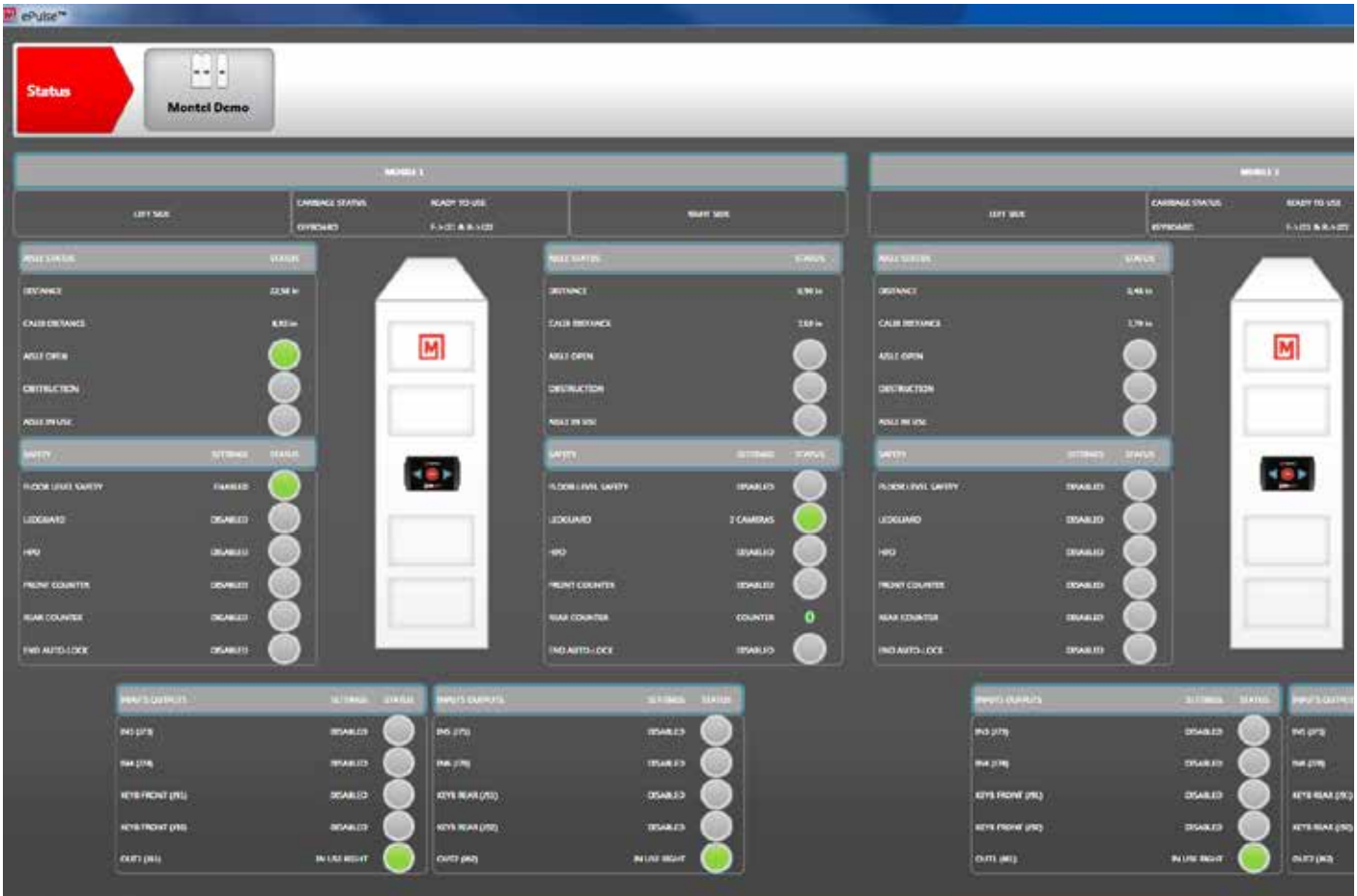

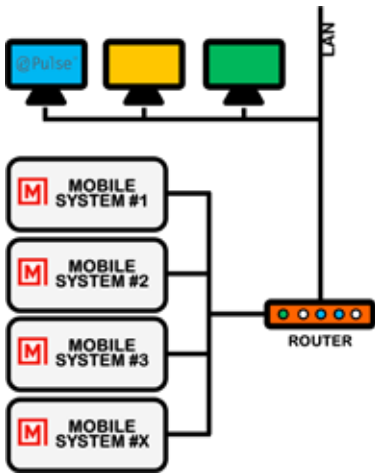

## BRONZE - LOCAL REMOTE MONITORING WITHOUT EXTERNAL CONNECTIVITY

### OBJECTIVE:

- Local remote monitoring for customers wanting to manage on their own the Montel powered mobile storage systems.
- No external internet access connectivity is authorized by the client to Montel's certified technicians.

**APPLICATIONS:** Highly secure facilities.

**CLIENTELE:** Large businesses, public services, governmental services, academic institutions, military bases

**PROPOSED BRONZE PACKAGE:** «ePulse™ Remote Monitoring Software» installed on a dedicated local computer.

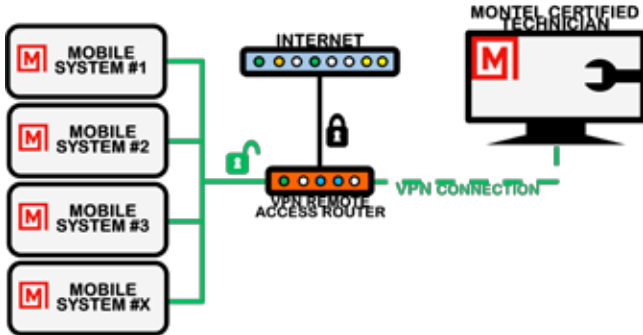

## SILVER - LOCAL REMOTE MONITORING WITH POSSIBILITY OF À LA CARTE EXTERNAL CONNECTIVITY

### OBJECTIVE:

- Local remote monitoring for customers wanting to manage the Montel powered storage systems with the possibility of granting access externally to Montel's certified technicians.
- Upon receipt of a phone call or email from the customer, Montel certified technicians would have the capability to connect, monitor and configure the Montel powered mobile storage systems.

**CLIENTELE:** Small and medium size businesses. customers located in remote or restricted areas, or distant from their authorized montel distributor or Montel Inc.

**PROPOSED SILVER PACKAGE:** «ePulse™ Remote Monitoring Software» installed on a dedicated local computer and a vpn remote access router.

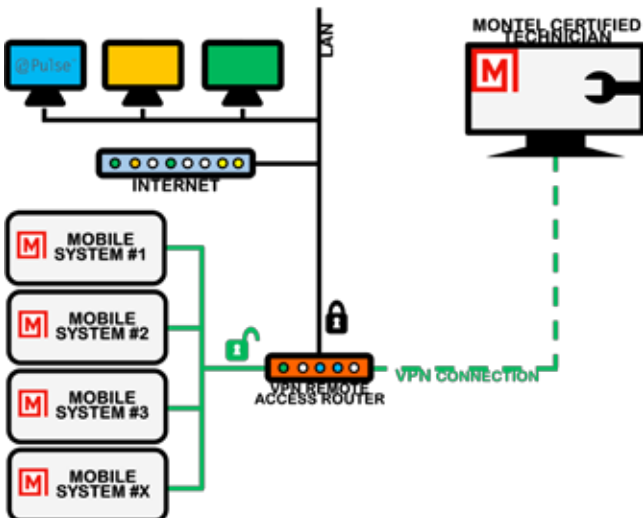

## GOLD - À LA CARTE REMOTE MONITORING EXTERNAL CONNECTIVITY

### OBJECTIVE:

- External remote monitoring for customers wanting Montel's certified technicians to connect, monitor and configure their Montel powered storage systems.

**CLIENTELE:** Small and medium size businesses. customers located in remote or restricted areas, or distant from their authorized montel distributor or Montel Inc.

**PROPOSED GOLD PACKAGE:** VPN remote access router and external à la carte remote monitoring services provided by Montel certified technicians.

**PRODUCTIVITY & TECHNOLOGY**

# PROGRAMMABLE AISLE **AUTOMATED** **FEATURES**

**MORE EFFICIENT THAN A MECHANICAL OR MANUAL MOBILE STORAGE SYSTEM,  
SAFERAK® IS A TIME-SAVER AS WELL AS A COST-SAVER.**

**WORKS WITH**  
SMARTSPACE 2P  
SAFEAISLE®  
RACK&ROLL 16P  
SAFERAK® 32P  
SAFERAK® 60P

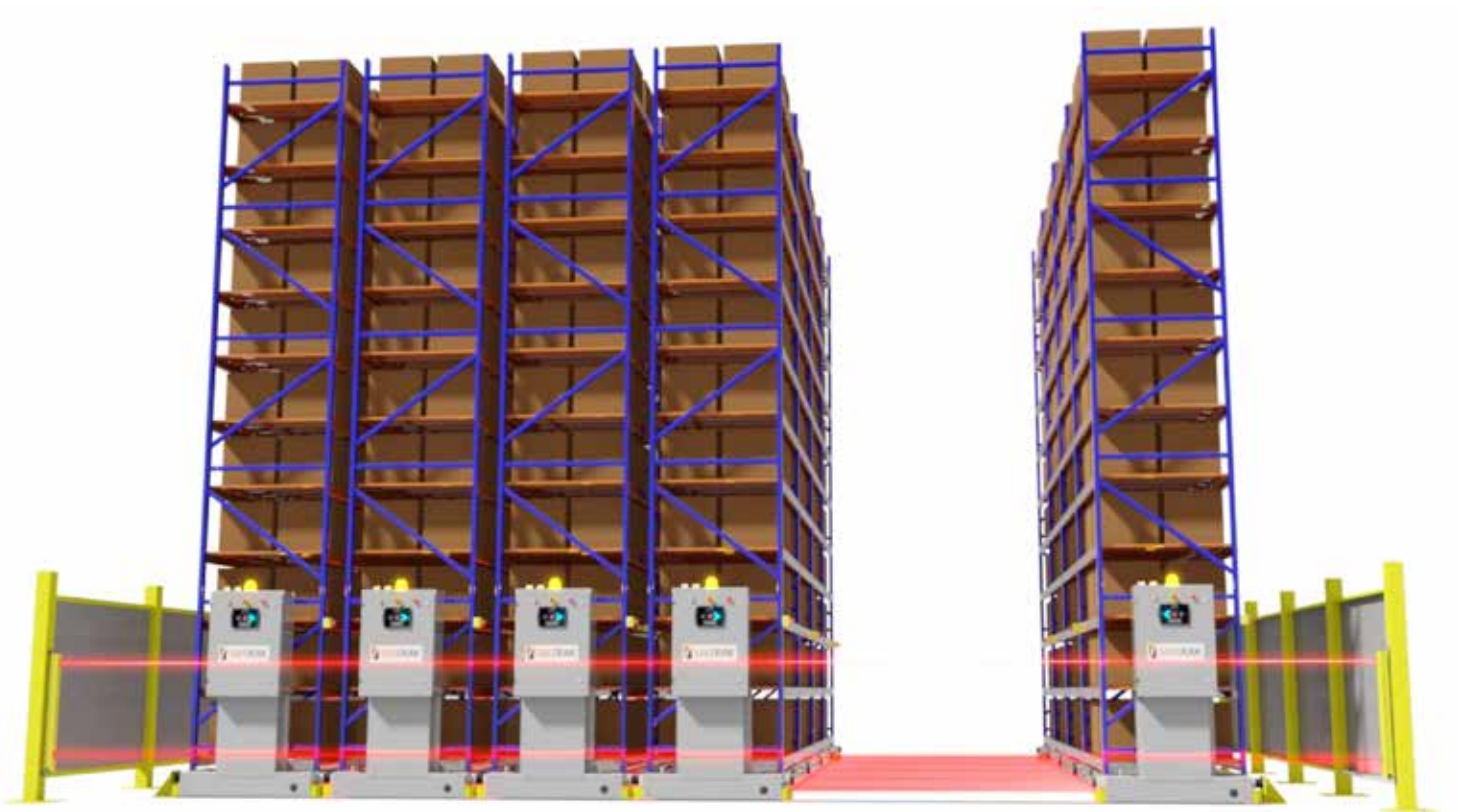



## PRIORITIZING AISLES

Users can increase their efficiency by configuring a specific priority aisle(s). While accessing an infrequently used aisle, SmartSpace 2P, SafeAisle®, RACK&ROLL 16P, SAFERAK® 32P and SAFERAK® 60P mobile racking automatically repositions the system to your desired predetermined aisle(s). The most frequently utilized aisle(s) will be preset to reopen automatically for the next user. You can eventually reconfigure your SmartSpace 2P, SafeAisle®, RACK&ROLL 16P, SAFERAK® 32P and SAFERAK® 60P powered mobile racking mobile system by programming aisles according to picking rates or pulls. This ensures quick access to your commonly stored materials. Program the Priority Aisle automatic feature with the PIN-Code Control or the optional ePulse™ Remote Monitoring Software.



## CLOSING ALL AISLES

Program your system to automatically close all aisles and lock once a user exits an aisle, or after a preconfigured period of inactivity. Configure your system to close all aisles and lock at a specific time after business hours, or open and unlock before business hours.



## OPERATING AISLES REMOTELY

Forklift operators can operate SmartSpace 2P, SafeAisle®, RACK&ROLL 16P, SAFERAK® 32P and SAFERAK® 60P powered mobile racking using a Wi-Fi remote control mini tablet. SmartSpace 2P, SafeAisle®, RACK&ROLL 16P, SAFERAK® 32P and SAFERAK® 60P mobile racking can also be operated from your computer with the optional ePulse™ Remote Monitoring Software.

### OPERATE THE MOBILE STORAGE SYSTEM REMOTELY WITH AN INDUSTRIAL RUGGED WI-FI REMOTE CONTROL

Forklift operators can operate the mobile storage system remotely with a commercial or industrial rugged remote control mini tablet. The mobile storage system can also be operated remotely from your computer with the optional ePulse™ remote monitoring software.

### ePulse™ REMOTE MONITORING SOFTWARE

ePulse™ provides many avenues to monitor potential issues with your system, provides quick diagnostics of the system to maximize your uptime, sends automatic email notifications of system errors, and ensures constant monitoring 24 hours a day, every day of the year.

The TCP/IP protocol facilitates the network connectivity from a computer to the Montel powered mobile storage system.

ePulse™ Remote Monitoring and Configuration Software allows onsite, and offsite monitoring if remote network connectivity access is granted, of any installed mobile storage system providing peace of mind to our customers. If authorized to access remotely the client's network, Montel certified technicians could be notified instantly by email in the unlikely event there is an issue with a powered storage system, and could provide statistics of the ins and outs of each aisle thereby providing data such as which SKUs are moving faster or slower, allowing to program automated priority aisles, adjustable speed settings (soft start, cruising speed, slow stop), adjustable aisle clearance between the mobile storage system, PIN codes management, etc.

At any time, the ePulse™ allows you to reconfigure your powered mobile racking to your preferred settings and parameters, and ensures performance and operations with assurance. ePulse™ allows numerous configurable operations to improve productivity and security remotely.

# CASE STUDIES

**PIONEER OF HIGH-DENSITY MOBILE SHELVING STORAGE SYSTEM SOLUTIONS IN NORTH AMERICA, MONTEL HAS INSTALLED THOUSANDS SYSTEMS IN OVER 68 COUNTRIES AROUND THE WORLD. MONTEL IS REPRESENTED BY A WORLDWIDE NETWORK OF DISTRIBUTORS. WHETHER LARGE OR SMALL INSTALLATIONS, MONTEL DELIVERS MORE THAN A STANDARDIZED PRODUCT.**



## **BUILT FOR DECADES**

Leverage engineered storage solutions that are built to last and optimize your operations with Montel's Industrial mobile storage systems.

Power. Performance. Strength. Durability. Whatever industrial applications you are involved in, those are words to live by. You need powerful, high-performance production and assembly systems and equipment that have the strength and durability to handle big loads and high volumes in pressure-packed environments.

At Montel, we believe industrial storage systems should meet the same rigorous, tough standards for handling supplies, tools, fixtures, service parts, packaging, samples and beyond.



## **WE BUILD SATISFACTION**

We have developed a comprehensive line-up of best-in-class mobile high-density racking and shelving solutions that are precision-engineered to deliver lasting high-capacity storage. Their versatility makes them the movable and powered storage of choice for any industry: aerospace, automotive, defense, distribution centers, food, manufacturing and pharmaceutical plants, third-party logistics, etc.

# OUR CASE STUDIES



## AIRBUS

Airbus turns to smart aerospace storage systems for greater capacity, risk prevention.

📍 ASHBURN, VIRGINIA, USA



## THE GROVE

With mobile vertical growing system, The Grove effectively doubled its on-site yield. Montel has the answer for all legalized cannabis growers worldwide.

📍 LAS VEGAS, NEVADA, USA



## IMMUNOTEC INC.

Montel's Saferak® 32P industrial powered mobile storage system instantly helped employees become more efficient.



## WILLIAMS SELYEM WINERY

The wine library storage system helps Williams Selyem Winery to increase its storage footprint without a costly expansion. Williams Selyem effectively quadrupled its storage potential to 2,000 wine cases with Montel storage solutions.



## ACURA DEALERSHIP

SmartSpace mobile racking effectively doubled this Acura dealership's tire storage capacity. After installing its brand-new storage system for its inventory of tires, this dealer can now store an average of 2,000 tires on site.



## HYATT REGENCY

Mobile shelving helps the Hyatt store more bags and materials with half the storage footprint. Even the fanciest establishments know about the value of spatial economy. That's why outfitting the luggage room with a 4D wide-span Mobilex® mobile shelving installation makes the most sense.



## HONDA DEALERSHIP

Honda dealership enhances its storage space.



## UNITED STATES ARMY

Montel provides united states army with a compact storage solution.

📍 UNITED STATES ARMY, CA, USA

## CASE STUDIES

# AIRBUS TURNS TO SMART AEROSPACE STORAGE SYSTEMS FOR GREATER CAPACITY, RISK PREVENTION

WITH HELP FROM MONTEL'S INDUSTRY-LEADING TECHNOLOGY AND SERVICE, AIRBUS WAS ABLE TO OPTIMIZE ITS OPERATIONS IN A HOST OF UNIQUE WAYS, ALL FROM SIMPLY MAKING THEIR AEROSPACE STORAGE SYSTEM SMARTER.







SAFERAK® 32P INDUSTRIAL  
POWERED MOBILE RACKING

AEROSPACE INDUSTRY

 ASHBURN, VIRGINIA, USA

“ The system was completed on time and on budget without any interruption to customer order flow. ”

## CHALLENGES

Sometimes, problems seem so glaring, we have no choice but to deal with the «elephant in the room». But for many companies, there simply isn't one large issue to address, but rather a host of small inconsistencies, a bunch of frayed ends in need of tying. It's very rare to find a solution that can straighten out these complications at once, but for the sake of a budget and time, it may be a business's only recourse.

Likewise, aerospace manufacturer Airbus and its materials center in Ashburn, Virginia, hoped to improve upon several different key elements at once. Like any other warehouse, the Ashburn facility was hampered by issues with plant cost-effectiveness, lack of vacancy and a logistics division that could be faster and more responsive if given the proper tools.

## SOLUTIONS

Airbus state-of-the-art aerospace storage system met and exceeded its expectations by addressing the company's concerns headlong. All in all, the structure combined both static and powered mobile racking for a total of 90,000 feet of space capable of storing nearly 3 million pounds of material. While the benefits of on-site storage in a warehouse speak for themselves, perhaps more important would be how this storage affects daily worker operations. After all, it's one thing to simply store a lot more and another thing entirely to store efficiently and in a manner conducive to a productive work environment that needs to meet its deadlines.

## PRODUCT FEATURES

A smart aerospace storage system powered by motorized carriages gives plant managers the opportunity to add an extra level of protection to what they store. Moreover, the closed, accordion-like design of electric mobile racking gives space otherwise reserved for aisles back to the facility's floor plan. This means workers manning lifting equipment have more room to move about, even when the warehouse reaches capacity.

This technology also helps battle a warehouse's greatest enemy: downtime. Businesses hemorrhage money every minute their facilities are shut down, be it through missed sales, undelivered goods or complications with customer service. Montel integrated a surge protector into the manufacturer's electrical mobile racking units to help safeguard against disruptions. In the event of total power loss, with the help of a handy ratchet, Airbus can still open and close the units with little effort and no electricity whatsoever.

Best of all, this smart storage installation didn't result in any extra construction or additions to the Ashburn facility and integrated smoothly into day-to-day functions. The implementation of Montel's powered mobile racking combines 60,000 square feet of traditional storage space into 30,000 feet of smart space without moving any walls or consuming more land. The system has the capacity to move more than 2.8 million pounds at any one time. For Airbus, that means greater volumes, higher efficiency and more ways to service its valued customers.

## CASE STUDIES

# IMMUNOTEC GOES MOBILE WITH SAFERAK® 32P

**GROWTH REQUIRED MORE ROOM IN A VERY LIMITED SPACE AND WITHIN THE SAME FOUR WALLS. OFF-SITE INVENTORY STORAGE WAS INCONVENIENT IN TERMS OF TRANSIT, CONTROL, COSTS, SECURITY, ACCESSIBILITY AND STORAGE CONDITIONS.**





Immunotec

“ The Montel SAFERAK® 32P mobile racking has significantly increased our storage capacity, stimulated the reorganization and rezoning of our warehouse, reduced our picking routes thus increased our overall effectiveness.

The system instantly helped our employees become more efficient. ”

## CHALLENGES

- Immunotec’s continual upward growth required additional inventory space
- Additional SKUs introduced to the marketplace required additional storage

## OBJECTIVES

- Increase storage capacity by 60%
- Increase productivity by relocating fast moving SKUs to another section of the warehouse thus reducing picking routes

## SOLUTIONS

Montel SAFERAK® 32P industrial powered mobile storage systems mounted on pallet rack for heavy-duty storage.

- Length: 58’ mobile carriages
- Aisle width: 8.75’
- System height: 20’
- Load capacity: 30,000 lb per section



SAFERAK® 32P INDUSTRIAL  
POWERED MOBILE RACKING

PHARMACEUTICAL INDUSTRY

With the assistance of its local Authorized Montel Distributor, Prisma Storage Solutions, Montel provided the following mobile racking systems:

## PRODUCT FEATURES

- Impact-resistant (against lift-trucks) infrared floor-level safety sweep on both sides of the aisles protecting users and materials.
- PIN-controlled access for added security
- Infrared adjustable proximity sensor to adjust the distance between each carriage.
- Impact-resistant zinc housing face panel controls
- Sealed membrane controls preventing dust infiltration, minimizing future maintenance.

## BENEFITS

- Significant short-term and long-term saving.
- 60% space saving.
- Provided room more inventory due to a significant sales growth.
- Condensed inventory storage.
- Storage space for more skus introduced to the marketplace.
- Overall improved efficiency and productivity (materials are more organized, less handling, easy to inventory control, accessibility, etc.).
- Added security.

## CASE STUDIES

# WHAT MOBILE TIRE STORAGE DID FOR ONE MONTEL CLIENT

RECENTLY, AN AUTHORIZED MONTEL DISTRIBUTOR PARTNERED WITH A LOCAL ACURA DEALERSHIP TO SOLVE ITS TIRE STORAGE TROUBLES. INSTALLING THIS STORAGE SYSTEM IN PARTICULAR DREW OUR ATTENTION TO TIRE STORAGE ISSUES IMPACTING MANY DIFFERENT BUSINESSES, APART FROM TIRE RETAILERS.





SMARTSPACE  
MOBILE RACKING

AUTOMOTIVE INDUSTRY

“ The audience looking for effective tire storage has grown significantly. ”

## CHALLENGES

We can all understand the tangible benefits of expanding storage capabilities for any business, but how will this storage change-up affect revenue related to tire sales? Before installing mobile racking, the dealership kept its limited excesses off-site, including off-season tires.

## SOLUTIONS

SmartSpace mobile racking effectively doubled the dealership's storage capacity. After installing its brand-new storage system for its inventory of tires, this dealer can now store between 1,900 to 2,200 tires on site, depending on the sizes it has in stock.

Additionally, customers pay roughly \$30 per tire for six months of seasonal storage at the dealership, \$60 for annual storage fees. For dealerships, more tire storage doesn't only mean more space for inventory, but also another potential revenue stream. Doubling a dealership's tire storage capacity doubles its selling power. With the space-efficient design of mobile racking, the dealership can service more customers looking for a place to keep their summer or winter tires off season. After all, not every homeowner has room in their garage for an extra set of tires, let alone multiple sets if they own more than one vehicle.

## BENEFITS

All things considered, the dealership's new SmartSpace mobile racking system will pay for itself in under two years. More importantly, snow tire sales can take off now that the dealership has the capability to house and sell a more diverse product line, as well as serve customers buying multiple sets of tires with their eventual storage needs.



## CASE STUDIES

# HONDA DEALERSHIP DEALERSHIP ENHANCES ITS STORAGE SPACE

**WHEN HONDA DEGIRO PROCEEDED WITH EXPANDING ITS COMMERCIAL FACILITY TO ACCOMMODATE BUSINESS GROWTH, SPACE OPTIMIZATION AND STORAGE UTILIZATION WERE KEY CONCERNS THAT NEEDED TO BE TAKEN IN CONSIDERATION.**





SMARTSHELF®  
SHELVING SYSTEM  
AUTOMOTIVE INDUSTRY

“ SmartShelf® flexibility and adaptability characteristics will help Honda Degiro reduce product storage costs. ”

## CHALLENGES

Challenged with these space concerns, the objective of Honda Degiro’s management team was to consolidate the storage of automobile supplies, parts and equipment in a user-friendly client environment for a quick and efficient customer service. After identifying and analyzing Honda Degiro’s storage needs and space availability, Montel’s storage professionals proposed its new flexible and innovative hybrid 4-Post shelving system, SmartShelf®.

## SOLUTIONS

Designed to be easily configured and reconfigured corresponding to the dimensions and weights of Honda Degiro’s current and future product storing needs, SmartShelf® allowed the service department technicians to store more, while considering a more efficient storage approach.



**CASE STUDIES**

# **CANNABIS VERTICAL GROWING SYSTEM BY MONTEL**

**MONTEL MOBILE VERTICAL GROWING SYSTEMS  
MET THIS CANNABIS DISPENSARY'S HIGH STANDARDS**







THE GROVE™



LAS VEGAS, NEVADA, USA



CANNABIS MOBILE VERTICAL GROWING SYSTEM BY MONTEL

AGRICULTURE INDUSTRY

“ With mobile vertical growing system, The Grove effectively doubled its on-site yield. ”

## CHALLENGES

The legal cannabis industry has taken root across the U.S. as this once black-market drug has gained national recognition for its medicinal and recreational uses.

Business has been booming for The Grove, a medical marijuana dispensary just outside the Las Vegas strip. While many of its successes can be attributed to its attention to growing plants naturally and sustainably, The Grove sought to enhance its use of space to deliver even greater efficiency.

## SOLUTIONS

Montel stepped in to help The Grove managers designed the ideal grow operation based on their industry's unique needs. After everything was said and done, Montel installed 29 42-foot long carriages spread across four rooms, increasing The Grove's storage capacity to over 6,380 square feet with Montel's powered mobile racking.

## PRODUCT FEATURES

For its 16,000-square-foot cannabis storage facility, The Grove chose powered mobile vertical growing system installations to optimize space in its three flower rooms (1,392 plants each for a total of 4,176) and a vegetation room, with plans to expand operations by another three flower rooms. By installing powered mobile vertical growing system throughout its facility, The Grove will reach a capacity of more than 8,352 plants!

## BENEFITS

The Grove's powered mobile system installations carry more than plants, but also water reservoirs, fuse boxes, fans, hoses and other equipment. Traditionally, prefabricated shelving might not have withstood the weight of all these different components. However, Montel's mobile vertical growing systems provide literal tons of holding power, and its highly customizable frame makes it simple for owners to organize their grow rooms as they please.



## CASE STUDIES

# WILLIAMS SELYEM WINERY LEARNED WORLD-CLASS WINES PAIR WELL WITH **SMARTER SHELVING**

THE WINE LIBRARY STORAGE SYSTEM HELPS WILLIAMS SELYEM WINERY DO MUCH MORE THAN SHELVE ITS GOODS: SOON AFTER, THE COMPANY REALIZED A STORAGE CAPACITY OF 500 CASES SIMPLY WOULDN'T DO. IT WOULD NEED TO INCREASE ITS STORAGE FOOTPRINT WITHOUT A COSTLY EXPANSION.





MOBILEX® MOBILE  
SHELVING MODULES

ALCOHOL & BEVERAGES INDUSTRY

“ We’d like to personally thank SF Space Solutions for a job well done. ”

## CHALLENGES

Wine libraries must be kept at an even temperature using heating, ventilation and air conditioning systems specifically designed to create an ideal environment. While these HVAC systems preserve the wine well, they do increase energy costs for the user as they must run constantly. Expanding the square footage of the library to make room for more storage would have not only cost a bundle in construction, but also raised the recurring energy costs for the winery.

## SOLUTIONS

After partnering with SF Space Solutions and installing six 16-foot Mobilex® mobile shelving modules across the wine library’s two rooms – along with freestanding racks along that back walls – Williams Selyem effectively quadrupled its storage potential to 2,000 cases, give or take a few dozen boxes of Magnum bottles. Instead, Williams Selyem trusted mobile shelving to grow its storage capabilities without increasing its energy consumption.

## BENEFITS

Like traditional libraries, Williams Selyem Winery wine library serves a purpose beyond simple storage. Batches stored therein require frequent testing to determine whether they are mature enough for sale. Williams Selyem wine specialists need room to pull designated batches from the shelves and taste them. With that in mind, the space cannot be cramped or completely devoted to storage. Luckily, because of the collapsible Mobilex® mobile shelving units, Williams Selyem staff can open and close aisles to give themselves enough space to freely move about the wine library at their leisure.



## CASE STUDIES

# HYATT REGENCY INDULGES ITS GUESTS WITH A NEW **LUGGAGE ROOM** FURNISHED WITH **MOBILE SHELVING**

HOTELS LIKE THE HYATT REGENCY IN DOWNTOWN SAN FRANCISCO, CALIFORNIA, WANT NOTHING MORE THAN FOR THEIR GUESTS TO LIVE IN THE LAP OF LUXURY. SO, WHEN TRAVELERS FROM FAR-OFF PLACES ARRIVE AT THE HYATT BEFORE CHECK-IN, HOTEL STAFF DOESN'T WANT THEM STUCK DRAGGING THEIR BAGS AROUND WHEN THERE'S SO MUCH OF THE BAY AREA TO EXPLORE.





4D WIDE SPAN MOBILEX®  
MOBILE SHELVING

DISTRIBUTION CENTERS INDUSTRY

## CHALLENGES

Hyatt Regency partnered with SF Space Solutions, a local Authorized Montel Distributor in San Francisco, to redesign its luggage storage room so its team of bellhops could more adequately provide for Hyatt guests.

## SOLUTIONS

Even the fanciest establishments know a thing or two about the value of spatial economy. That's why outfitting the luggage room with a 4D wide span Mobilex® mobile shelving installation makes the most sense. Thanks to its collapsible design, mobile shelving helps the Hyatt store more bags and other materials with half the storage footprint.

For Hyatt regency bellhops, the difference was night and day. The mobile shelving installation expanded the Hyatt's luggage storage capacity by 250 percent, up to as many as 500 bags and suitcases! Hyatt Regency Bell Captains also told Montel and SF Space Solutions their bellhops are now able to retrieve luggage 75 percent faster thanks to the organization achieved by their new mechanical-assist mobile shelving modules.

## PRODUCT FEATURES

Mobilex® mobile shelving systems offer hotels the flexibility to reshape their luggage storage themselves without the need for tools or maintenance professionals. Heavy-duty wide span shelving can be adjusted in 1-inch increments to accommodate large suitcases or any unusually shaped objects visitors might have in tow.

Better still, Mobilex® shelving can include other kinds of storage features to create multipurpose spaces. A luggage room could also be a coat check if, like the Hyatt Regency, hotels added clothing racks with garment rods to their luggage storage installations. Furthermore, hotels could also tack on a few extra mobile shelving modules and use the additional space for general storage.

Even shelving has the power to knock guests off their feet if it makes a statement or blends well with the decor. The Hyatt chose a breathtaking shade of deep red for its luggage room storage, but other hotels can choose from an array of color options that suit their tastes.



## CASE STUDIES

# MONTEL PROVIDES UNITED STATES ARMY WITH SAFERAK® 32P

WITH A SIGNIFICANT VOLUME INCREASE FOR ITS STRATEGIC AND CRITICAL MATERIAL STORED TO CAPACITY, UNITED STATES ARMY WAS EXPERIENCING AN OUTAGE OF ITS STORAGE SPACE.





 UNITED STATES ARMY, CA, USA



SAFERAK® 32P INDUSTRIAL  
POWERED MOBILE RACKING

MILITARY & DEFENSE INDUSTRY

“ We grew from the inside thereby  
no need to expand. ”

## CHALLENGES

Rather than proceeding with the building of a new warehouse facility, United States Army wanted to minimize construction costs while optimizing its warehouse storage space.

## SOLUTIONS

A state-of-the-art high-density storage system was proposed to United States Army with 25-foot carriages for a maximized space utilization within its warehouse.

## PRODUCT FEATURES

With the assistance of its local Authorized Montel Distributor, BMH Equipment Inc., Montel provided the following custom designed military storage solution:

- Powered SAFERAK® 32P compact storage system with pallet racks on motorized carriages.
- Mobile storage racks designed for a load capacity performance of 30,000 pounds.
- Integrated built-in control panels to operate the system and display its status.
- Proximity detectors controlled electronically.
- 2 foot-level infrared safeties for each aisle.
- Flashing light and horn safety features that provide visual and audible warnings.

## OUR CLIENTS



## CERTIFICATIONS & STANDARDS



For the most recent version of this document, please go to the Montel website at [www.montel.com/en/design-center](http://www.montel.com/en/design-center). In case of discrepancy, the web version takes precedence over any printed literature.



877-935-0236  
[info@montel.com](mailto:info@montel.com)  
[www.montel.com](http://www.montel.com)